

EFFECT OF PRE-TREATMENTS ON THE KINETICS OF SUBSEQUENT AEROBIC AND
ANAEROBIC BIODEGRADATION OF POLYLACTIC ACID (PLA)

By

LUIS FERNANDO VARGAS DELGADO

A DISSERTATION PRESENTED TO THE GRADUATE SCHOOL
OF THE UNIVERSITY OF FLORIDA IN PARTIAL FULFILLMENT
OF THE REQUIREMENTS FOR THE DEGREE OF
DOCTOR OF PHILOSOPHY

UNIVERSITY OF FLORIDA

2008

© 2008 Luis Fernando Vargas Delgado

To my wife, son and parents

ACKNOWLEDGMENTS

I express my sincere appreciation to my advisor Dr. Bruce Welt. Definitely, he is an exceptional professor and a good friend, very dedicated and always happy to support me with his valuable guidance. I am grateful to my committee members Dr. Art Teixeira, Dr. Balaban, Dr. Pullammanappallil, and Dr. Beatty for their orientation. I thank my colleagues Richlet Dorcent, Ayman Abdellatief and Cecilia Amador for their collaboration and friendship. I express my gratitude to Steve Feagle, James Rummell and Billy Duckworth whose technical expertise was very valuable for this research. Also, I was happy to interact with my colleagues from the bioprocess engineering lab, who were always available to assist me. I show my sincere appreciation to the University of Florida and the Agricultural and Biological Engineering Department for their funding and support.

TABLE OF CONTENTS

	<u>page</u>
ACKNOWLEDGMENTS	4
LIST OF TABLES	8
LIST OF FIGURES	9
LIST OF ABBREVIATIONS.....	12
ABSTRACT.....	14
CHAPTER	
1 INTRODUCTION	16
2 EVALUATION OF TREATMENTS TO REDUCE PLA MOLECULAR WEIGHT	18
Introduction.....	18
Materials and Methods	19
Materials.....	19
Methods of Analysis.....	19
Subjective assessment of structural integrity	19
Determination of weight loss	19
Determination of molecular weight.....	20
Determination of degree of chain scission	20
Determination of mechanical properties	21
Exposure of PLA to Gamma Irradiation	21
Exposure of PLA to Electron Beam Irradiation	21
Immersion of PLA in Alkaline Media.....	23
Immersion of PLA in Acid Media.....	24
Exposure of PLA to Steam.....	24
Results and Discussion	24
Exposure of PLA to Gamma Irradiation	24
Mechanical properties	24
Molecular weight.....	25
Degree of chain scission.....	26
Exposure of PLA to Electron Beam Irradiation	26
Before composting	26
Structural integrity.....	26
Molecular weight.....	27
Degree of chain scission.....	27
After composting.....	28
Structural integrity.....	28
Weight loss.....	29
Molecular weight.....	30

D-value	30
Immersion of PLA in Alkaline Media	31
Structural integrity	31
Weight loss	31
Molecular weight	32
Immersion of PLA in Acid Media	32
Structural integrity	32
Weight loss	32
Exposure of PLA to Steam	32
Structural integrity	32
Molecular weight	33
Conclusions	34
3 KINETICS OF REDUCTION OF MOLECULAR WEIGHT IN STEAM-TREATED PLA	47
Introduction	47
Methods	47
First Order Reaction Model	47
Depolymerization of PLA to Lactic Acid Resulting from Steam Exposure	48
Results and Discussion	49
First-Order Reaction Model	49
Depolymerization of PLA to Lactic Acid Resulting from Steam Exposure	49
Conclusion	50
4 DEVELOPMENT OF METHODS TO EVALUATE AEROBIC BIODEGRADATION OF PLA	54
Introduction	54
Materials and Methods	55
Method of Flexible Bags	55
Method of Rigid Containers with Plastic Film Lids	57
Method of Perforated Jars	58
Results and Discussions	59
Method of Flexible Bags	59
Method of Rigid Containers with Plastic Film Lids	61
Method of Perforated Jars	61
Conclusion	62
5 BIODEGRADATION OF TREATED PLA UNDER ANAEROBIC CONDITIONS	71
Introduction	71
Materials and Methods	72
Weight loss of PLA in Water under Anoxic Conditions	72
Weight Loss of Irradiated PLA in Anaerobic Biological Media	72
Biochemical Methane Potential (BMP) of Steam-Treated PLA in Anaerobic Biological Media	73

Results and Discussion	74
Weight Loss of PLA in Water Under Anoxic Conditions.....	74
Weight Loss of Irradiated PLA in Anaerobic Biological Media.....	74
Biochemical Methane Potential (BMP) of Steam-Treated PLA in Anaerobic Biological Media.....	75
Conclusions.....	76
6 BIODEGRADATION OF STEAM-TREATED PLA UNDER COMPOSTING CONDITIONS.....	80
Introduction.....	80
Material and Methods.....	81
Steam-Treated PLA Biodegradation in Compost.....	81
Kinetics of Steam-Treated PLA Biodegradation in Compost.....	82
Weight Loss of Steam-Treated PLA in Compost and Comparison with other Common Feedstock	82
Results and Discussion	83
Steam-Treated PLA Biodegradation in Compost.....	83
Kinetics of Steam-Treated PLA Biodegradation in Compost.....	84
Weight Loss of Steam-Treated PLA in Compost and Comparison with other Common Feedstock	85
Conclusion.....	85
7 CONCLUSIONS.....	92
8 RECOMMENDATIONS FOR FUTURE WORK.....	95
APPENDIX	
A CHARACTERISTICS OF THE COMPOST	96
B PERMEABILITY TO CARBON DIOXIDE.....	97
C VOLUME OF BIOMASS.....	99
D BAG VOLUME.....	100
E OVERALL COEFFICIENT OF DIFFUSION.....	101
F NUTRIENT FORMULA FOR ANAEROBIC MEDIA.....	103
LIST OF REFERENCES.....	104
BIOGRAPHICAL SKETCH	108

LIST OF TABLES

<u>Table</u>		<u>page</u>
2-1	Linear regression outputs and D-values of e-beam irradiated/composted PLA	46
2-2	Comparison of treatments to reduce PLA molecular weight.....	46
4-1	Biodegradation of PLA by method of flexible bags	69
4-2	Biodegradation of PLA by the method of perforated jars.....	69
5-1	Production of methane in steam-treated PLA.....	79
5-2	Weight loss of untreated PLA in water under anoxic conditions	79
6-1	pH of biomass (compost + biodegraded PLA)	91
6-2	Parameters of the logistic model ($\%biod = a / (1 + (t/x_0)^{-b})$)	91
A-1	Characteristics of prepared mature compost.....	96
E-1	Carbon dioxide effusion rate estimation through 5-hole lid	102
F-1	Anaerobic media formulation	103

LIST OF FIGURES

<u>Figure</u>	<u>page</u>
2-1 Drinking cups made of PLA	35
2-2 Principle of intrinsic viscosity method for determination of molecular weight	35
2-3 Stress at break of γ -irradiated PLA samples	36
2-4 Strain at break of γ -irradiated PLA samples	36
2-5 Molecular weight of γ -irradiated PLA samples	37
2-6 Determination of G_s in PLA γ -irradiation	37
2-7 E-beam irradiated PLA showing voids formation	38
2-8 Molecular weight of e-beam irradiated PLA	38
2-9 Determination of G_s in PLA e-beam irradiation	39
2-10 Temperature profile of compost bulk	39
2-11 E-beam irradiated PLA after 6 weeks in compost	40
2-12 Structural integrity of e-beam irradiated/composted PLA	40
2-13 Weight loss of e-beam irradiated/composted PLA	41
2-14 Molecular weight of e-beam irradiated/composted PLA	41
2-15 Hydrolysis of PLA	42
2-16 Plots of e-beam irradiation dose vs. $\log M_w$ for D-values estimation	42
2-17 Structural integrity of PLA subjected to alkaline media	43
2-18 Weight loss of PLA subjected to 0.1N NaOH	43
2-19 Molecular weight of PLA subjected to alkaline media	44
2-20 Structural integrity of steam-treated PLA	44
2-21 Pores in steam-treated PLA	45
2-22 Molecular weight of steam-treated PLA	45
3-1 First-order reaction plots for steam-treated PLA	51

3-2	Arrhenius plot for steam-treated PLA.....	51
3-3	Spectra of lactic acid obtained by FTIR-ATR.....	52
3-4	Mass balance of PLA treated with steam at extreme conditions.....	52
4-1	Set up for plastic biodegradation assessment in compost - ASTM D5538.....	63
4-2	Interactions in flexible bags.....	63
4-3	Pictures of flexible bags with biomass biodegrading.....	64
4-4	Chemical formula of PLA.....	64
4-5	Interactions in rigid container with plastic film lid.....	65
4-6	Picture of rigid container with plastic film lid.....	65
4-7	Interaction in perforated jar.....	66
4-8	Picture of jar filled with biomass and perforated lid.....	66
4-9	Picture of compost plus PLA after 40 days, in and out of the bag.....	67
4-10	Biodegradation of PLA using the method of flexible bags.....	67
4-11	Biodegradation of PLA using the method of rigid containers with plastic film lids.....	68
4-12	Overall effective coefficient of diffusion for CO ₂ through 5 holes.....	68
4-13	Biodegradation of PLA using the method of perforated jars.....	69
5-1	Supposed anaerobic reactions for PLA anaerobic biodegradation.....	77
5-2	BMP bottle with anaerobic media.....	77
5-3	Steam-treated ground PLA.....	77
5-4	Weight loss of irradiated PLA.....	78
5-5	Conversion of steam-treated PLA (120°C x 3h) to CH ₄ under anaerobic conditions.....	78
6-1	Main reactions in PLA biodegradation.....	86
6-2	“Head start” effect.....	87
6-3	“Acceleration” effect.....	87
6-4	Biodegradation of steam-treated PLA over time in compost.....	88

6-5	Biodegraded PLA in compost.....	88
6-6	Logistic model fit for PLA biodegradation data.....	89
6-7	Weight loss of steam-treated PLA in compost compared with corrugated board and wood.....	89
6-8	Corrugated paperboard subjected to compost for 14 days.....	90
6-9	Wood subjected to compost for 14 days.....	90
6-10	Steam treated PLA (120°C x 3h) subjected to compost for 14 days	90
B-1	Mounted system to determine CO ₂ transmission rate.....	98
B-2	Arrhenius plot for activation energy determination (CO ₂ permeability).....	98
D-1	Volume-meter designed for bag volume determination.	100
E-1	Carbon dioxide concentration in headspace over time	102

LIST OF ABBREVIATIONS

<i>A</i>	:	Area (cm ²)
<i>D</i>	:	Irradiation dose (kGy)
<i>D_{ef}</i>	:	Coefficient of diffusion (mol CO ₂ /h/%)
<i>E</i>	:	Thickness of film (mil)
<i>E_a</i>	:	Activation energy (KJ/mol)
<i>G_s</i>	:	Degree of chain scission (w/o units)
<i>k</i>	:	Reaction rate constant or kinetic constant (h ⁻¹)
<i>k_o</i>	:	Pre-exponential factor (h ⁻¹)
<i>M</i>	:	Molecular weight (g/mol)
<i>M_n</i>	:	Number-average molecular weight (g/mol)
<i>M_{n, o}</i>	:	Number-average molecular weight, initial (g/mol)
<i>M_v</i>	:	Viscosity-average molecular weight (g/mol)
<i>M_w</i>	:	Weight-average molecular weight (g/mol)
<i>N_A</i>	:	Avogadro number = 1.023 x 10 ²³
<i>P</i>	:	Permeability (mol-mil/atm-day-m ²)
<i>P_{CO2}</i>	:	Permeability to CO ₂ (mol-mil/atm-day-m ²)
<i>P_o</i>	:	Pre-exponential factor for permeability (mol-mil/atm-day-m ²)
<i>p_{atm}</i>	:	Pressure, atmospheric (atm)
<i>p_{CO2}</i>	:	Partial pressure of CO ₂ (atm)
<i>p_{vap}</i>	:	Vapor pressure (atm)
<i>R</i>	:	Gas Law constant (82.057 atm-cc/mol°K or 8.31 J/mol°K)
<i>T</i>	:	Temperature, absolute (°K)
<i>t</i>	:	Time (h or days)

V	:	Volume (cc)
V_{hs}	:	Volume of headspace (cc)
V_{bag}	:	Volume of bag (cc)
$V_{bag\ tot}$:	Volume of bag, total (cc)
V_{film}	:	Volume of film (cc)
W	:	Weight (g)
W_o	:	Weight, initial (g)
W_f	:	Weight, final (g)
w	:	Weight loss (%)
ρ	:	Density (g/cc)
η	:	Number of moles
μ_{red}	:	Reduced viscosity (ml/g)
$[\mu]$:	Intrinsic viscosity (ml/g)
$\% CO_2$:	Percentage of CO ₂ (%)
$[CO_2]$:	Concentration of CO ₂ (cc CO ₂ / cc total)

Abstract of Dissertation Presented to the Graduate School
of the University of Florida in Partial Fulfillment of the
Requirements for the Degree of Doctor of Philosophy

EFFECT OF PRE-TREATMENTS ON THE KINETICS OF SUBSEQUENT AEROBIC AND
ANAEROBIC BIODEGRADATION OF POLYLACTIC ACID (PLA)

By

Luis Fernando Vargas Delgado

May, 2008

Chair: Bruce Welt

Major: Agricultural and Biological Engineering

The purpose of this work was to evaluate treatments that increase polylactic acid (PLA) biodegradation during composting and anaerobic digestion. Treatments were chosen on the potential to reduce molecular weight and affect structural integrity of the polymer. Five potential treatments were investigated, and it was found that steam exposure was the most effective treatment with up to 94% molecular weight reduction with 120°C steam for 4 hours.

To determine kinetics of PLA molecular weight reduction after exposure to steam, a first-order reaction model was proposed. It was found that the model, which is time and temperature dependent, fits experimental data well, with activation energy, E_a , of 52.3 KJ/mol. In addition, it was demonstrated that steam treatments hydrolyze polymer molecules, resulting in depolymerization to lactic acid. At 120°C, weight loss of PLA was 84.7% after 24 hours, indicating significant conversion to lactic acid.

To develop a simple method to evaluate PLA aerobic biodegradation in compost, the fundamentals of conversion were examined, and three approaches were designed and assessed. These methods are referred to as methods of “flexible bags”, “rigid containers with plastic lids”

and “perforated jars”. It was found that the method of perforated jars was most reliable, simple and consistent to apply.

To evaluate effects of treatment in subsequent anaerobic digestion, weight loss and biochemical methane potential (BMP) of treated samples were investigated under mesophilic and thermophilic anaerobic conditions. Untreated PLA did not degrade under mesophilic conditions. However, degradation did occur under thermophilic conditions, producing 187 ccCH₄/g at 58°C after 56 days. The best scenario evaluated, was steam-treated PLA at 120°C for 3 hours subjected to anaerobic thermophilic conditions, where the yield of methane was 225 ccCH₄/g after 56 days.

While untreated PLA biodegrades more slowly than common organic feedstock, steam-treated PLA biodegraded faster. Results of this investigation show that treatment of PLA with steam at 120°C for 3 hours reached 60% degradation in 14 days. Compost was not altered by PLA conversion.

CHAPTER 1 INTRODUCTION

Recent efforts to improve sustainability imply, among other things, using renewable resources, reducing municipal waste and avoiding solid, liquid (including oils) and gaseous emissions [1]. Plastic packaging, while providing valuable contributions to society is often perceived as a solid waste burden. Traditional plastic packaging does contribute to virtually non-degradable solid waste in landfills. In addition, most polymers are petroleum-based, and therefore, obtained from non-renewable resources. These issues have sparked interest in biobased and biodegradable plastics [2].

Poly(lactic acid) (PLA) is a biodegradable plastic polymer derived from renewable resources, such as corn, that can be used in a variety of packaging applications. During industrial composting, PLA is assumed to degrade through biological activity to carbon dioxide and water. Compostability of PLA has been discussed by different authors, and the agreement is that it truly occurs at temperatures around 58°C after several weeks [3, 4, 5]. These characteristics coupled with recent capital investments to produce commercial quantities of the material have made PLA a viable option for replacing fossil fuel derived polymers for certain applications [6].

As increasing amounts of PLA are finding packaging applications, a number of practical challenges have become apparent including PLA's instability at moderate temperature and relative humidity [7, 8], and PLA's relatively low biodegradation rate relative to typically composted organic wastes, which is preventing commercial compost operators from accepting PLA. Therefore, most post-consumer PLA is being sent to landfills for disposal where breakdown does not readily occur [9]. Since companies promote PLA's sustainable qualities, consumers expect that PLA waste will be either composted or recycled, thus completing the

sustainable cycle. Sending PLA to sanitary landfills threatens to violate consumer and public trust in sustainable packaging materials.

Biodegradation is a two-step process. First, polymer molecules are hydrolyzed into smaller pieces resulting in lower molecular weight polymers, oligomers and monomers. Second, biological action of microorganisms metabolizes these smaller molecules resulting in conversion to carbon dioxide and water [10]. Therefore, it is suspected that treatments capable of rapidly reducing PLA molecular weight will allow biological conversion sooner, which should lead to an overall reduction in biodegradation time.

The motivating hypothesis of this work is that treatments capable of disrupting the polymer matrix and/or reducing molecular weight should result in reduced overall composting time. Additionally, in the event that composting time is reduced, experiments were designed to determine whether pretreatments accelerated conversion kinetics or simply provided a head start to the composting process that subsequently proceeded at the typical rate. Treated PLA will already be constituted by smaller molecules when added into the composter, so less time is needed to get to this point. The acceleration concept is based on increased metabolic activity associated at higher concentrations of lower molecular weight polymer.

The main objective of this research was to evaluate effects of potential pretreatments on kinetics of subsequent PLA aerobic and anaerobic biodegradation, and to determine whether or not treatments will allow PLA to completely degrade within the time frame of normal organic feedstock. Secondary objectives were to develop a methodology to measure PLA biodegradation rate in a composting process and to determine kinetics of molecular weight reduction in treated PLA.

CHAPTER 2 EVALUATION OF TREATMENTS TO REDUCE PLA MOLECULAR WEIGHT

Introduction

Composting is a well known process that is mainly used to break down organic materials such as yard and food wastes. While PLA is susceptible to breakdown during composting, it has been found that PLA degradation kinetics are considerably slower than typical organic feedstocks, and currently, little, if any PLA waste is sent to industrial composting facilities. Commercial PLA packages have been shown to be incompletely degraded after 28 days of composting [3, 4] and recycling is currently not taking place [5]. Therefore, PLA represents a potential bottleneck to composting operations, which could result in PLA being diverted to sanitary landfills for disposal. In this regard, PLA's promise of sustainability would not be completely fulfilled. Therefore, a key question for compostable sustainable plastics is how to improve degradation kinetics without compromising important useful qualities of the polymer.

Some authors have reported on effects of gamma irradiation [11], electron beam irradiation [12], enzymatic hydrolysis [13] and chemical hydrolysis on poly (L-lactide) acid (PLLA) [14]. Results showed reductions in molecular weight and associated loss of tensile strength, which are indicators of polymer degradation. It is believed that such initial damage to the polymer will help to at least provide a head start and may actually accelerate degradation kinetics of PLA during composting.

This chapter evaluates potential treatments capable of reducing PLA molecular weight. For this purpose, five treatments were chosen: (1) exposure to gamma irradiation, (2) exposure to electron beam irradiation, (3) immersion in alkaline media, (4) immersion in acid media and (5) exposure to saturated steam. Additionally, other analyses such as structural integrity and weight

loss were also performed. These treatments were compared and the most effective was selected for further investigation under composting conditions (Chapter 6).

Materials and Methods

Materials

Thermoformed PLA drinking cups (Fabri-Kal, Inc., Kalamazoo, MI) were obtained from TREEO Center at the University of Florida (Figure 2-1). Cup dimensions were measured using a caliper (Mitutoyo Model CD-6 CS, Mitutoyo Corp., Japan) and are provided in Figure 2-1. Wall thicknesses were 150-200 μ m and bottoms were about 750 μ m.

Methods of Analysis

Subjective assessment of structural integrity

Polymer appearance and physical characteristics changed significantly due to various treatments. Descriptive observation was used to compare samples at specific times during each study. Assessment consisted of evaluation by touch, sight, physical attributes such as brittleness, opacity, whitening, voids/pores formation, swelling, twisting, curling, conversion to powder and weakening. A digital microscope (INTEL model APB-24221-99A, Mattel Inc., China) at magnifications of 10X, 60X and 200X was used to enhance observational power.

Determination of weight loss

Weight loss (w) was calculated as a percentage using Equation 2-1.

$$w = \frac{W_o - W}{W_o} \times 100\% \quad (2-1)$$

A precision scale (Voyager® Pro/Ohaus, Ohaus Corp., Pine Brook, NJ) was used for individual weight measurements. In all cases at least three repetitions were performed, but since there was too much variability, only averages are presented in the graph. PLA samples were carefully selected, cleaned and dried.

Determination of molecular weight

Intrinsic viscosity was used to determine weight-average molecular weight, M_w , and viscosity-average molecular weight, M_v , of PLA samples in accordance to ASTM D2857-95 [15]. Kinematic viscosities, μ , of PLA dilutions (up to 1% V/V) were determined at 30°C using chloroform as solvent and a calibrated capillary viscosimeter (Cannon-Ubbelodhe Type N°25, State College, PA). These values were used to determine reduced viscosity, μ_{red} , and intrinsic viscosity, $[\mu]$, of each treated sample. Finally, molecular weight, M , was estimated using the Mark-Houwink model (Equation 2-2), which relates molecular weight to the intrinsic viscosity. Figure 2-2 shows the principle of this method.

$$[\mu] = kM^a \quad (2-2)$$

Constants, k and a , used for PLA in chloroform at 30°C were 0.0131ml/g and 0.777 for M_v , and, 0.0153ml/g and 0.759 for M_w [16]. At least two repetitions were performed for analysis of gamma and e-beam irradiated (not composted) PLA.

Determination of degree of chain scission

It is well known that irradiation of polymers causes two main and opposing effects including, scission and crosslinking. The important physical fact is that one chain scission causes one molecule to become two, and one crosslink causes two molecules to become one [17]. To evaluate the predominance of chain scission rather than crosslinking, the concept of degree of chain scission, G_s , was applied. This is defined as the number of radiolysis events caused by the absorption of 100eV of radiation and can be calculated by Equation 2-3 [11]. Number-average molecular weight, M_n , was assumed to be equal to viscosity-average molecular weight, M_v , since doses were below the gel dose [18]. High values of G_s indicate chain scission predominance over crosslinkings.

$$G_s = \frac{N_A \left(\frac{I}{M_n} - \frac{I}{M_{n,o}} \right)}{6.24 \times 10^{16} D} \quad (2-3)$$

Determination of mechanical properties

A 4301-Series Instron was used to determine stress and strain at break at a temperature of 25°C in PLA samples. The equipment was set at a crosshead speed of 30 mm/min, and samples set in the machine direction with a gage length of 30 mm. At least five repetitions were performed in each tensile test to obtain representative average values. This analysis was conducted for PLA samples exposed to gamma irradiation.

Exposure of PLA to Gamma Irradiation

Rectangular thin sheets (50mm x 10mm x 150-200µm) and shredded pieces (~4mm edge) obtained from PLA cup walls (Figure 2-1) were prepared and irradiated in a foil lined paperboard canister (73 mm diameter × 180 mm height). The canister was placed inside the irradiation chamber (FL Accelerator Services and Technology, Gainesville, FL) where it was exposed to γ-rays from a Cesium-137 source at a dose rate of 0.78 kGy/h. Samples were irradiated in air in order to promote scission over crosslinking [11, 17]. The canister was removed from the irradiation chamber after 92 and 221 hours. Dosimetry showed that samples achieved absorbed doses of 72 kGy and 172 kGy, respectively. Irradiated samples were kept in storage at 25°C for at least 4 days prior to analysis. Mechanical properties (stress and strain at break), molecular weight and degree of chain scission were subsequently assessed.

Exposure of PLA to Electron Beam Irradiation

Electron beam irradiation was applied to PLA samples in order to evaluate effects before and after composting. Square sheets (31.5mm x 31.5 mm x 0.75mm) obtained from flat bottoms of PLA drinking cups (Figure 2-1) were prepared and subjected to electron beam irradiation (FL

Accelerator Services and Technology, Gainesville, FL) at a dose rate of 2.4 kGy/min. Bunches of PLA samples were placed together in Petri dishes that resulted in less than 1 cm overall thickness [19]. Samples were transported by conveyor into the irradiation chamber for each irradiation pass. Multiple passes were required to achieve desired doses. Since the goal was to induce chain scissions, and since scission is aided by oxygen [11], no effort was made to protect samples from oxygen. Samples were removed from the irradiation tunnel after 2, 4 and 6 passes at 36kGy per pass, achieving absorbed doses of 72, 144 and 216 kGy. Irradiated samples were kept in storage at 25°C at least 4 days prior to analysis. Electron beam irradiated samples were evaluated for structural integrity, molecular weight and degree of chain scission.

After e-beam irradiation, PLA samples were subjected to composting. For this purpose, individual, previously e-beam irradiated samples, were placed inside hand-made, heat sealed nylon screen envelopes and placed in a rotational composter (CompostTwin, Mantis, Southampton, PA) equipped with thermocouples in a computer controlled environmental chamber (Environmental Growth Chambers, Chagrin Falls, OH) at 35°C. A standard organic feedstock recipe was developed for this study and used throughout. Organic feedstock consisted of freshly cut grass from the University of Florida's golf course (58%, C:N=10), saw dust (11%, C:N=500), virgin corrugated paperboard (11%, C:N=170) and mature compost (20%). Raw materials were sliced or cut in order to achieve a homogeneous mixture. Also, this formulation met the requirement of initial optimum nutrient balance carbon/nitrogen ratio of 30. Water was periodically added to the mixture in order to maintain moisture content between 55% and 70%, and to promote and maintain biological activity [20]. Initial net weight in the composter was about 118 lb and was rotated daily to ensure adequate mixing and aeration.

Screened sample envelopes allowed for intimate contact between samples and bulk compost and protected against loss of non-mineralized sample during critical phases of decomposition. Thermocouples inside the composter measured temperature of the composting biomass over 10 weeks. Structural integrity, weight loss, molecular weight and irradiation induced molecular weight loss D-value were determined in PLA samples for assessment of electron beam irradiation effect on them.

Irradiation D-values are often used to describe microbial inactivation. A D-value represents the dose required to cause one log cycle change in a measured parameter [21, 22, 23], which means reducing its value to its 10%. Here, we used D-value to describe the irradiation dose required to change molecular weight by one log cycle. D-values were calculated for composted samples after 0, 1, 2 and 6 weeks. D-values were determined from inverses of slopes from linear regressions of \log_{10} Mw versus absorbed dose. Therefore, steeper curves represent lower D-values and greater sensitivity of molecular weight to dose.

Immersion of PLA in Alkaline Media

Rectangular sheets (6cm x 4cm x 0.75mm) obtained from PLA drinking cup bottoms (Figure 2-1) were placed in 50 ml 0.1N NaOH and 50 ml of 1N NaOH, and stored for 22 days at 25°C. Samples immersed in 0.1N NaOH were evaluated over time for structural integrity, weight loss, and weight-average molecular weight. Initially, the experimental design considered evaluating both conditions (0.1N and 1N), however, PLA samples immersed in 1N NaOH fragmented in such small parts that it was impossible to monitor weight loss or obtain a representative sample for molecular weight analysis. Therefore, the only samples evaluated were those subjected to 0.1N NaOH.

Immersion of PLA in Acid Media

Rectangular sheets (6cm x 4cm x 0.75mm) obtained from PLA drinking cup bottoms (Figure 2-1) were placed in 100ml of aqueous solution of nitric acid at 0.1% or 0.016N (pH 1), and stored for 22 days at 25°C. At the beginning and end of the experiment, structural integrity and weight loss were assessed. Change in molecular weight was not evaluated because results of previous analyses proved that PLA samples were not sensitive to acids.

Exposure of PLA to Steam

Rectangular sheets (6cm x 4cm x 0.75mm) obtained from PLA cup bottoms (Figure 2-1) were prepared and placed inside jars. Lids were adapted with two holes (about 1cm diameter) to allow steam transfer. Jars were placed in a vertical still retort where steam was fed and temperature/pressure was controlled with a pneumatic system. Experiments were run at 100, 110 and 120°C, for 1, 2, 3, 4 and 8 hours. After each treatment, samples were quickly cooled in air to room temperature and dried in an oven at 105°C until constant weight. Structural integrity and molecular weight of steam-treated PLA samples were evaluated.

Results and Discussion

Exposure of PLA to Gamma Irradiation

Mechanical properties

PLA made from pure L-Lactide, also called poly(L-lactide), is semi-crystalline. Incorporation or co-polymerization with isomers M-lactide or D-lactide decreases degree of crystallinity, causing polymers to become more amorphous [24, 25]. PLA resins can be tailor-made for different fabrication processes, including injection molding, sheet extrusion, blow molding, thermoforming, film forming, or fiber spinning. Critical factors include degree of branching, D-isomer content, and molecular weight distribution. For thermoforming, D-isomer

content might be in the range of 4–8% [25]. Unirradiated PLA mechanical properties have been studied by others and comparisons to oriented polystyrene (OPS) have been made [26].

Rectangular PLA samples showed increasing brittleness with absorbed dose. At higher doses, samples were sensitive to even careful handling. Results for stress and strain at break (rupture strength) using the Instron 4301 are shown in Figure 2-3 and Figure 2-4. Higher gamma irradiation doses reduced PLA mechanical properties in a manner that is similar to traditional thermoplastic polymers including polystyrene, polypropylene and polyurethane [27, 28, 29].

Other authors studied effects of electron beam irradiation on lactides and found similar trends [12, 30]. Stress at break of PLA samples irradiated at 172 kGy dropped from 127 MPa to 18MPa, a factor of about 7. For the same samples, strain at break dropped from 75% to 2%. These numerical values represent a marked increase in brittleness of the irradiated PLA samples. This behavior suggests crystalline damage due to free radical attack [12].

Molecular weight

Figure 2-5 shows weight-average molecular weight, M_w , and viscosity-average molecular weight, M_v , for un-irradiated and γ -irradiated PLA samples. Since intrinsic viscosities are lower at higher absorbed doses, molecular weights also conform to the Mark-Houwink equation. This result confirms that chain scission was the predominant effect of tested irradiation treatments. Weight-average molecular weight dropped 86% from 16.3×10^4 to 2.3×10^4 . Number-average molecular weight dropped 85% from 15.1×10^4 to 2.2×10^4 . These molecular weight reductions were more severe than those found by others for poly(L-lactic) acid [11]. In this work, the material was commercial thermoformed PLA that includes D-isomers, and this may be the reason for such difference.

Ratios of weight average to viscosity average molecular weight, M_w/M_v , were 1.08, 1.05 and 1.03 for absorbed doses of 0, 72 and 172 kGy, respectively. These narrow molecular weight distributions tend to suggest that PLA used for these samples was created from a ring-opening polymerization process. This happens to be the process claimed by the PLA manufacturer [25].

Degree of chain scission

The plot of $1/M_n - 1/M_{n,0}$ vs. dose is shown in Figure 2-6. The straight line suggests that chain scission was random [31]. Chain scission yield, G_s , was found to be 2.21, which is greater than values found by other researchers for gamma irradiated poly (L-lactic) acid [11], e-beam irradiated poly (lactide-co-glycolide) and e-beam irradiated poly (L-lactide) [11, 12]. This suggests that gamma irradiation has a higher effect on chain scission than e-beam irradiation, and that inclusion of D-isomers in the polymer structure increase such sensitivity.

Exposure of PLA to Electron Beam Irradiation

Before composting

Structural integrity

Figure 2-7 shows digital pictures at magnifications of 10X of irradiated PLA surface. Mainly, four phenomena occurred after e-beam exposure: (a) twisting, (b) change of color, (c) voids formation and, (d) structural weaknesses. Also, it was observed that these changes were more severe as irradiation doses increased.

Twisting may be explained by the relatively high irradiation dose rate resulting in temperature increase and associated relaxation of polymer chains. The glass transition temperature for PLA has been reported to be around 58°C [10]. Sample color changed from transparent to yellow, however, transparency returned after about one week. Irradiated polymers form unstable chromatic groups, possibly by the introduction of conjugation to the carbonyl groups of the chain [32]. It is well known that radiation induced chemistry continues after

exposure and this is a reason that plastic radiation dosimeters require at least 48 hours before reaching final significant changes.

The phenomenon related with voids formation is common in abused irradiated materials. Generally, there should be void nuclei formation followed by swelling, which is attributed to an increase of temperature and irradiation dose [33]. Irradiated PLA samples showed internal swelling voids that increased in number and size as irradiation dose increased. Void formation is likely the result of a combination of chain scission, gas formation, swelling, and associated polymer rearrangement due to heating.

Polylactic acid samples became extremely brittle, suggesting a reduction in chain length with irradiation dose. This behavior also suggests damage to crystalline regions due to free radical attack [12].

Molecular weight

Figure 2-8 shows how PLA molecular weight was affected by e-beam irradiation. PLA samples treated with 0, 72, 144 and 216 kGy of e-beam irradiation achieved weight-average molecular weights of 1.7×10^5 , 8.2×10^4 , 6.9×10^4 and 6.1×10^4 g/mol. These values represent about 48%, 40% and 35% of the initial molecular weights.

Comparing with results for gamma irradiation (M_w at 172 kGy = 14% of untreated M_w), it can be said that PLA is more vulnerable to gamma rather than e-beam irradiation. For any of these treatments, decreases in molecular weight occur due to scission of the main backbone [12].

Degree of chain scission, G_s

The plot of $1/M_n - 1/M_{n,0}$ vs. dose, D , is shown in Figure 2-9. The degree of chain scission, G_s , was found to be 0.52, which is lower than the 2.21 value obtained for gamma irradiation using Cs-137. It is likely that higher dose rates involved with electron beam irradiation

effectively reduced local oxygen concentrations, which helped to protect polymer samples during irradiation.

After composting

After 2 weeks of composting, most organic feedstock biomass excluding PLA looked and smelled as finished compost. Literature indicates that this aerobic bioprocess releases water vapor (0.6-0.8 g/g), carbon dioxide and heat (about 25 KJ/g), which cause the compost temperature to rise significantly [20]. Figure 2-10 shows that compost temperatures quickly rose to about 68°C during the first week, fell to 45°C by the second week, and leveled off at the chamber controlled temperature of 35°C by the third week.

Samples of PLA after 6 weeks are shown in Figure 2-11. While breakdown was most severe in highest irradiation dose samples, none of the samples were completely mineralized.

Structural integrity

Figure 2-12 shows views of irradiated/composted PLA and reveals effectiveness of irradiation as a pre-composting step for enhancing PLA breakdown. Structural integrity was affected and samples turned from clear to milky, smooth to porous, and glassy to powdery. The effect was more intense as irradiation dose increased. Samples turned very brittle, showing sensitivity to even careful handling.

During the composting process, PLA samples are subjected to high relative humidity and temperature. These conditions are favorable for hydrolysis, where a reorganization of the smaller chain molecules causes an increase of the polymer crystallinity and opacity [34]. In addition, lower molecular weight polymers are more hydrophilic than corresponding high molecular weight polymers because of higher concentrations of hydrophilic end groups (both hydroxyl and carboxyl). Hydrophilicity affects osmotic pressure causing influx of water into the polymer matrix, which causes a buildup of hydrostatic pressure and consequent cracking and formation of

microcavities. Microcavitation occurs due to leaching of PLA material into the surrounding medium [35].

As long as hydrolysis produces small molecules of PLA, microbial activity will commence. Microorganisms begin to assimilate small molecules of PLA releasing carbon dioxide and water vapor, and weakening carbon to carbon bonds. It is presumable that the combination of these hydrolytic and biological effects is responsible for changes in structural integrity of PLA, turning it from glassy to porous and finally to powder.

Weight loss

Figure 2-13 shows results of weight loss of irradiated/composted PLA over time. Reduction of weight suggests metabolic conversion of polymer in compost or into a soluble form. Greater irradiation doses and compost times resulted in increasing weight loss. For instance, un-irradiated PLA samples reduced weight by 1.3% after 10 weeks of composting whereas samples with absorbed doses of 216 kGy had reduced weight by 9.4%.

This study exposed a critical aspect of PLA breakdown and compost behavior. Essentially, PLA requires relatively warm temperatures in order to soften and open the polymer structure to biological attack. As biological activity quickly progressed, a lot of heat was released in a relatively short time. This time was too short to sufficiently convert PLA. Converters and manufacturers of PLA claim that biodegradation of the polymer takes place only at 58°C for more than 6 weeks. Here, temperature was variable and below 58°C after the second week.

After a few weeks in the composter, PLA samples with absorbed doses of 144 and 216 kGy turned very brittle and began to disintegrate from mechanical rotation of the composter. It is likely that these smaller pieces, with larger surface area to volume ratios, and lower molecular weights due to irradiation, provided some advantage even as microbial activity diminished over time.

Molecular weight

Figure 2-14 shows how molecular weight of e-beam irradiated PLA was affected over composting time. Final weight-average molecular weights of irradiated/composted PLA samples were 3.55×10^4 , 1.86×10^4 , 1.25×10^4 and 1.06×10^4 g/mol for the absorbed doses of 0, 72, 144 and 216 kGy, respectively. These values represent 21%, 11%, 7% and 6% of initial un-irradiated PLA molecular weight. Therefore, even when breakdown was not totally achieved, it was demonstrated that e-beam irradiation is effective in improving degradation of PLA during subsequent composting.

During the composting process, hydrolysis of polymers leads to molecular fragmentation, which can be regarded as a reverse poly-condensation. This process starts with a water uptake phase followed by a splitting of ester bonds in a random way according to the Flory principle [33]. High relative humidity and temperature provide conditions for cleavage of the ester linkages by water uptake and successive reduction in molecular weight [3, 36], as illustrated in Figure 2-15.

After hydrolysis, microorganisms assimilate lactic acid oligomers that may be soluble, releasing carbon dioxide and water. This two-step process demands reduction in PLA molecular weight early in the composting process. Nevertheless, rate of molecular weight reduction turned slower after the second week due to a reduction of microbial activity as evidenced by low temperature (35°C instead of recommended 58°C) and depletion of nutrients [20].

D-value

Figure 2-16 shows D-value plots for molecular weight versus dose after 0, 1, 2 and 6 weeks in the composter. Associated linear regression data and D-values are summarized in Table 2-1. Good linearity is observed in all plots with r-squares above 0.93.

The D-values of irradiated PLA were about 430, 560, 380 and 410 kGy for 0, 1, 2 and 6 weeks of composting. Initial D-value suggests that e-beam irradiation treatment of 430 kGy on PLA will reduce its molecular weight in 90%. The apparent increase in D-value (lower apparent sensitivity to irradiation) during the first week in compost may be due to chain recombination as compost temperatures increased above T_g. After the first week, D-values take their initial values, probably due to lower temperature.

These results suggest that the primary effect of electron beam treatments on PLA composting behavior is the initial reduction of molecular weight. Irradiation essentially provides a head-start on PLA breakdown, but it does not appear to significantly increase sensitivity of PLA to hydrolysis during composting.

Immersion of PLA in Alkaline Media

Structural integrity

Over time, it was noticed that PLA samples subjected to 1N NaOH fragmented but without losing tensile properties. Samples remained hard and brittleness was fairly consistent. For both conditions (0.1N NaOH and 1N NaOH), edges of samples were observed to become rougher with concentration and time. Figure 2-17 shows magnified pictures (x10) to illustrate this phenomenon.

Weight loss

Samples of PLA immersed in 1N NaOH fragmented over 22 days to such an extent that monitoring weight loss was not possible. For PLA samples immersed in 0.1N NaOH for 22 days, weight loss was around 14% as shown in Figure 2-18.

Since brittleness was not affected, but weight dropped, it is believed PLA dissolves under alkaline conditions, which is not the same as hydrolysis. Polymer dissolution is a consequence of molecular disentanglements and occurs more intensely on the surface than internally due to the

direct contact with solvents in these areas. That phenomenon caused a heterogeneous sample in terms of entanglements.

Molecular weight

Exposure of PLA to alkaline media for 22 days did not significantly affect weight-average molecular weight (Figure 2-19). Presence of peaks ranging between 1.38×10^5 and 1.66×10^5 g/mol may be attributed to sample heterogeneity in terms of entanglements, which occur more at the surface rather than in the center. Thus, it may be possible that test samples were more representative of surface material, or vice versa, and affected the numerical results. It is important to recall that an assumption of the intrinsic viscosity method for molecular weight estimation is that entanglements are the same in the whole sample [37]. It appears that this assumption may not be valid in this case.

Immersion of PLA in Acid Media

Structural integrity

Structure was not affected by a solution of nitric acid 0.1% or 0.016N (pH=1) after 22 days. There was no change in color, toughness, brittleness, weakness, or any other phenomena. This observation suggests that PLA is not vulnerable to acids at a temperature of 25°C.

Weight loss

Dry weights of PLA samples did not change after 22 days. Absence of weight loss means that dissolution or reaction of PLA did not occur in acid media at 25°C.

Exposure of PLA to Steam

Structural integrity

Samples of PLA exposed to steam for 4 and 8 hours displayed shrinking, brittleness and pore formation (Figure 2-20). These changes tended to be more severe as steam temperature and time increased.

Shrinking is attributed to application of temperatures above the glass transition temperature ($T_g=58-70^\circ\text{C}$) for PLA [10]. The glass transition is a second-order thermodynamic transition where polymers turn from glassy to rubbery state. In this state, change of volume with temperature is intensified and is revealed through shrinking and twisting observed in samples. The mechanism of this phenomenon is translational motion of molecules and cooperative wriggling and jumping of segments of molecules, leading to flexibility and elasticity [37].

Increased brittleness was quite noticeable, and samples more intensely treated were more sensitive to subsequent handling. Samples generally exhibited cracks and broke easily. This suggests formation of amorphous regions caused by smaller molecules, rearrangement and rapid cooling.

Pores formed during treatment are shown in Figure 2-21. This demonstrates severe disruption of PLA structure as well as exposure of greater areas of polymer that can be attacked during subsequent composting. The mechanism of pore formation was not determined, but is likely to be related to regional leaching of PLA to the surrounding medium as a result of hydrolysis, leaving cavities or pores.

Molecular weight

Molecular weight analysis was conducted for PLA samples exposed up to 4 hours in steam. Beyond this time, molecular weight distributions were too broad for analysis. Figure 2-22 shows how PLA molecular weight was affected by steam treatments. Initial weight-average molecular weight was about 2.10×10^5 g/mol. After 4 hours at 100, 110 and 120°C , samples achieved weight-average molecular weights of 6.00×10^4 , 2.88×10^4 and 1.19×10^4 g/mol, respectively. These values represent about 29%, 14% and 6% of the initial molecular weight, for each respective treatment.

Data reported by other authors show that polyamide 11 subjected to high temperatures in acidified water (pH 4) reduces molecular weight by half in about 40 days at 100°C, and 15 days at 120°C [38]. Results here show that PLA exposed to similar treatments reduces molecular weight by half in about 2.2 and 0.5 hours, at each respective temperature. While this comparison indicates that PLA is a good candidate for steam hydrolysis, it also suggests that steam treatments may also serve as a means to separate PLA from other plastics in the waste stream.

Dramatic decreases in molecular weight are the result of hydrolysis caused by high temperature and relative humidity, and can be regarded as a reverse poly-condensation. Splitting of PLA ester bonds requires water and is helped with temperature, occurring in a random way according to the Flory principle [34]. More severe treatments would involve more energy with sufficient moisture, yielding higher chain scission, and therefore, lower final molecular weights. The degree of chain scission was not determined for steam treatment, since crosslinking does not take place.

Conclusions

After evaluating different treatments to reduce PLA molecular weight, it was concluded that exposure to steam is most rapid and effective. Samples of PLA treated for 4 hours with steam at 120°C became extremely brittle and steam caused weight-average molecular weight to decline by 94%. The mechanism of steam-treated PLA molecular weight reduction is basically thermal hydrolysis.

Gamma irradiation is the second ranked treatment regarding PLA molecular weight reduction. Samples treated with 172 kGy γ -irradiation decreased molecular weight by 86%. Here, the main mechanism for this reduction is radiolytic chain scission. Using electron beam irradiation, results were less satisfactory, which is likely due to protection from oxygen. In an

additional experiment, e-beam irradiated PLA samples showed more sensitivity to composting conditions than untreated PLA samples, but even so, they did not achieve complete biodegradation.

Use of alkaline and acid solutions to enhance PLA hydrolysis was not successful at the low temperatures applied. Alkaline solutions promoted polymer dissolution, which might prove useful as part of a combined approach for accelerating PLA degradation.

Table 2-2 summarizes molecular weight reduction results for each treatment. Given availability, familiarity and effectiveness of steam treatment it is likely that steam would be the treatment of choice for accelerating PLA degradation.

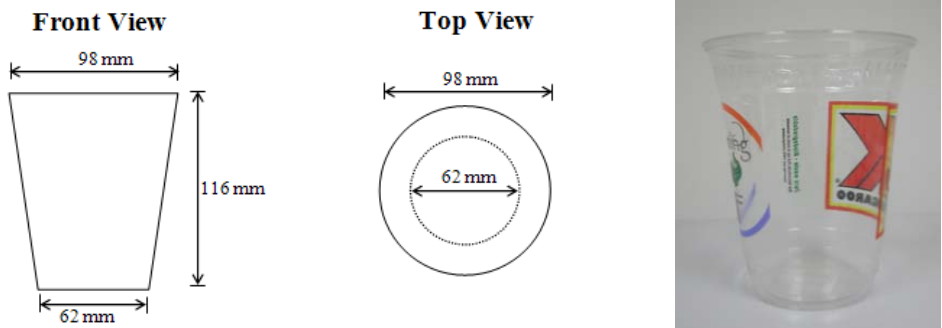

Figure 2-1. Drinking cups made of PLA

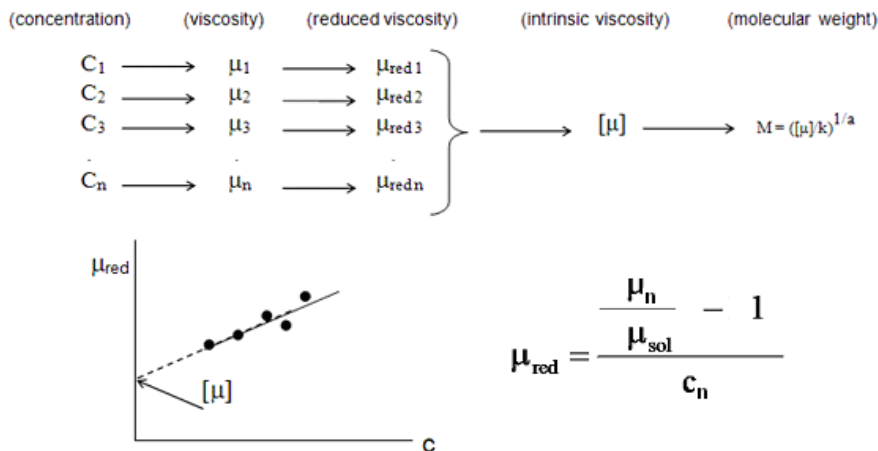

Figure 2-2. Principle of intrinsic viscosity method for determination of molecular weight

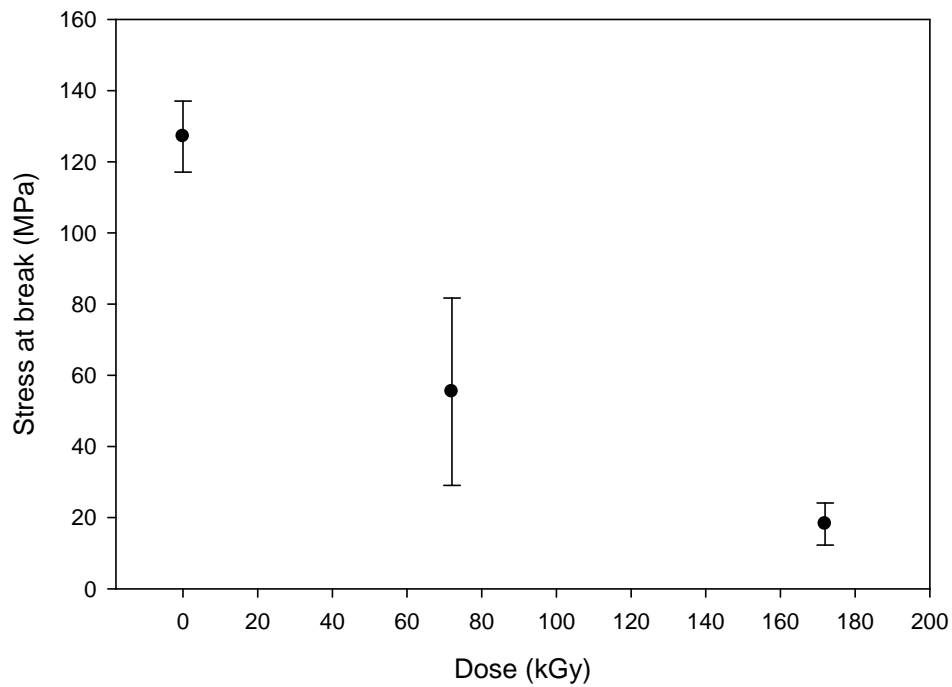

Figure 2-3. Stress at break of γ -irradiated PLA samples

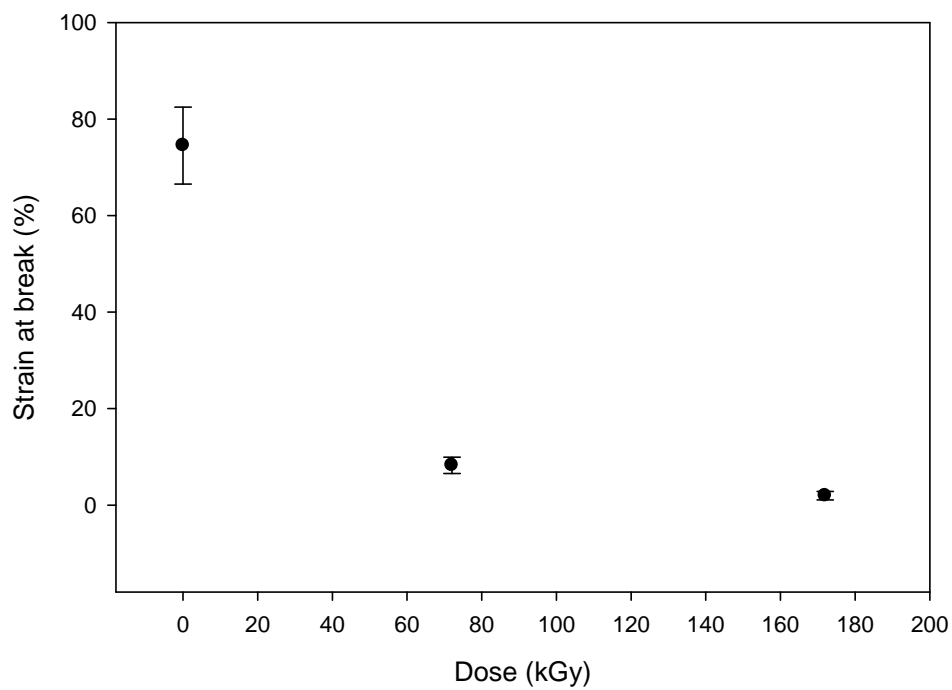

Figure 2-4. Strain at break of γ -irradiated PLA samples

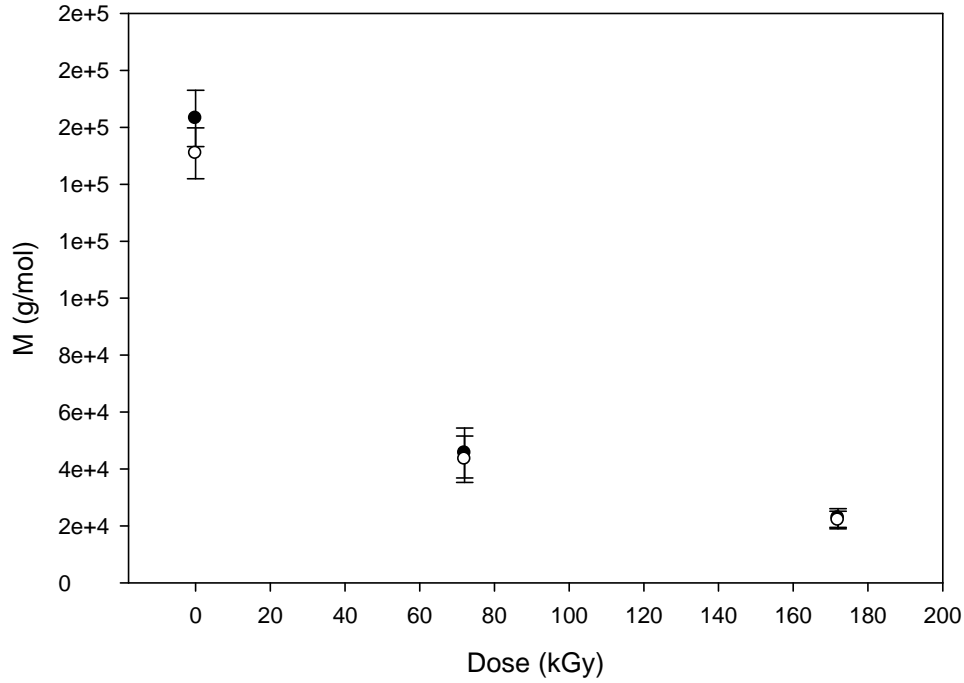

Figure 2-5. Molecular weight of γ -irradiated PLA samples: ● M_w , ○ M_v

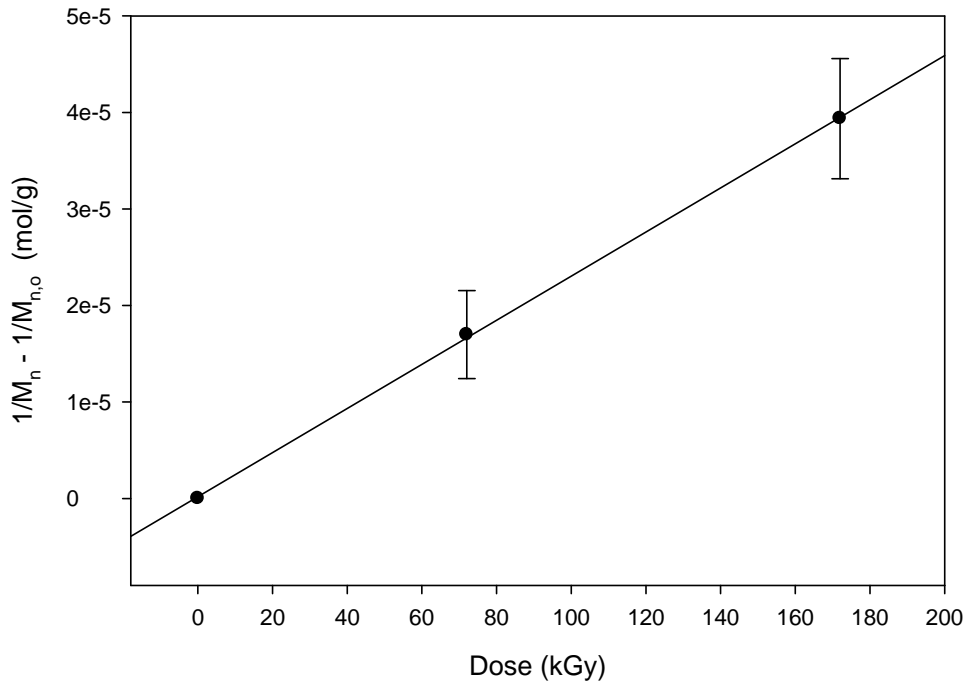

Figure 2-6. Determination of G_s in PLA γ -irradiation: $G_s = 2.21$

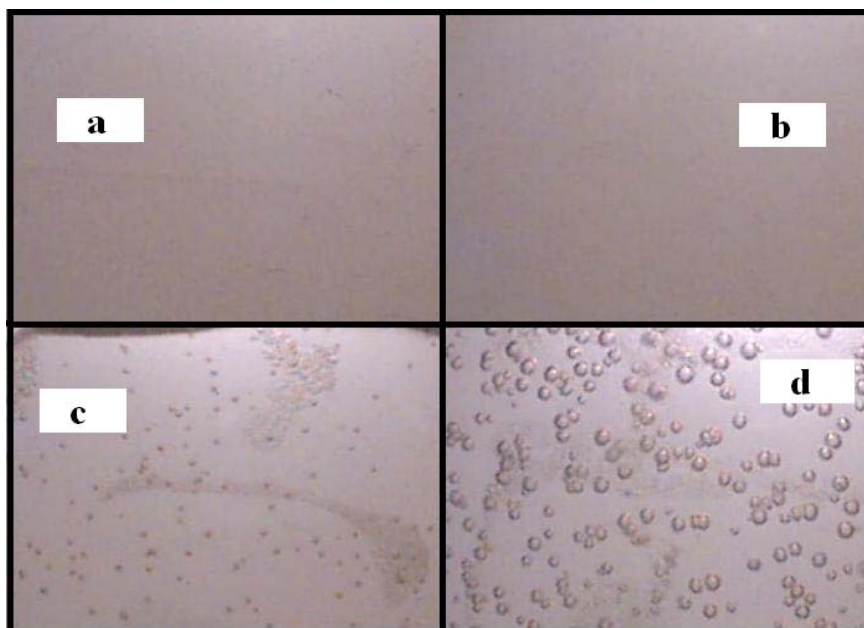

Figure 2-7. E-beam irradiated PLA showing voids formation: (a) 0 kGy, (b) 72 kGy, (c) 144 kGy, (d) 216 kGy

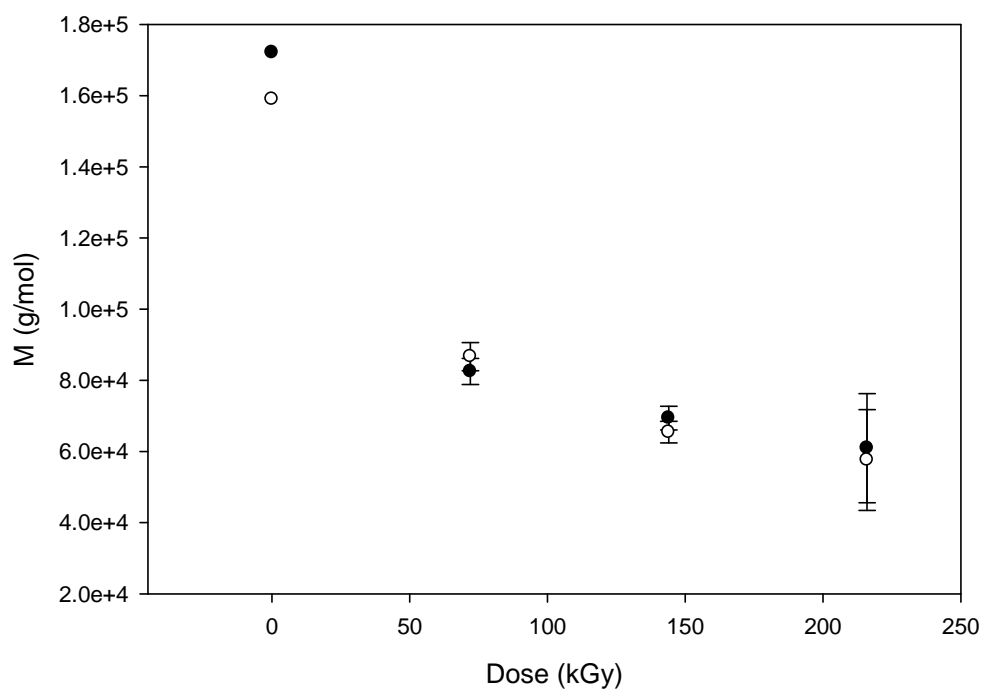

Figure 2-8. Molecular weight of e-beam irradiated PLA: ● M_w , ○ M_n

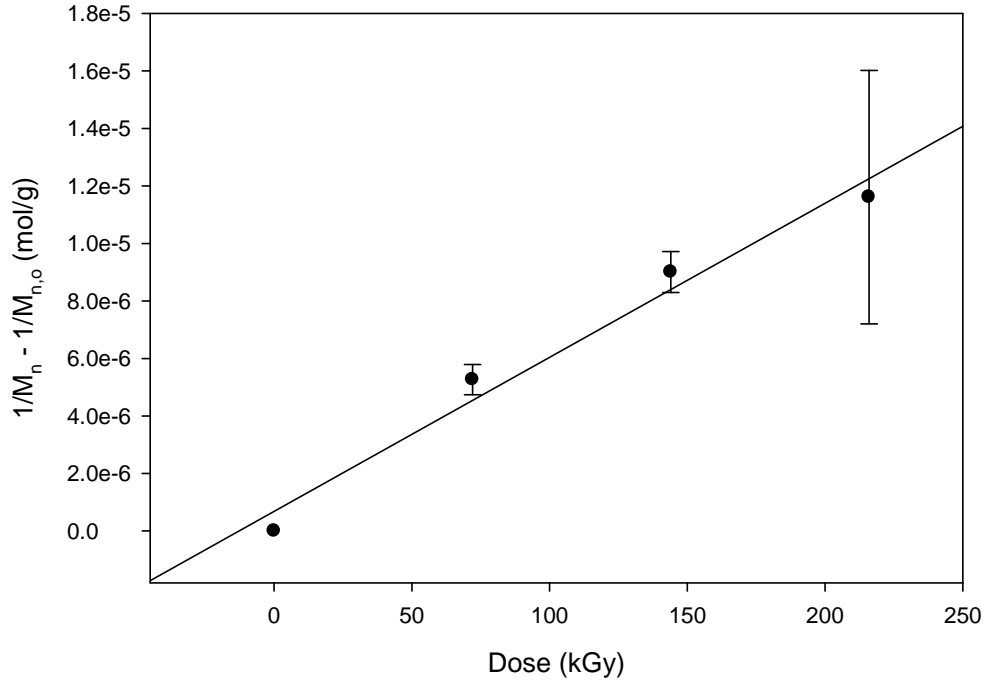

Figure 2-9. Determination of G_s in PLA e-beam irradiation: $G_s = 0.52$

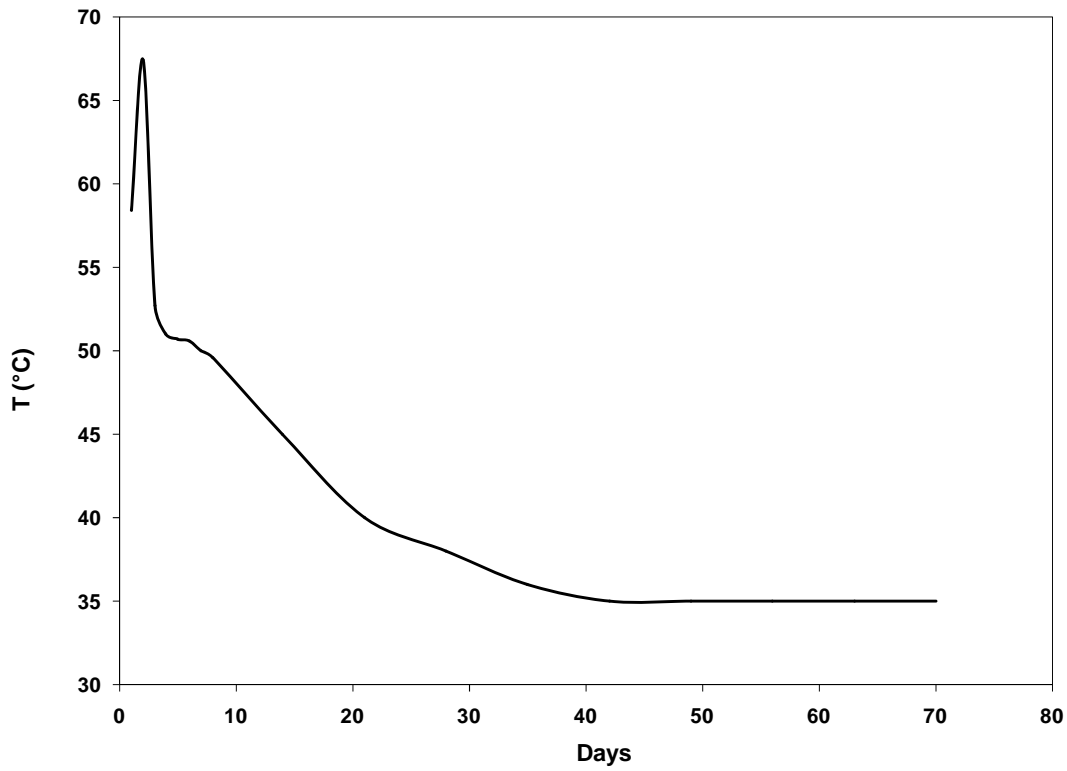

Figure 2-10. Temperature profile of compost bulk

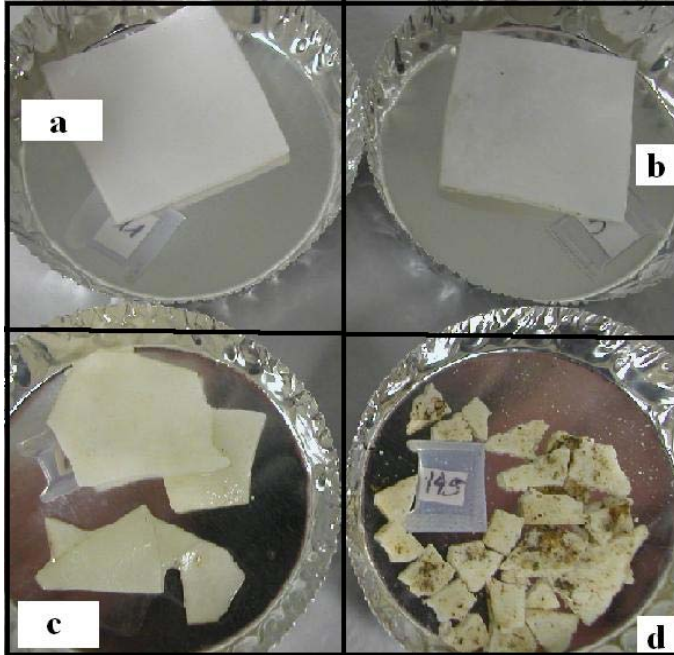

Figure 2-11. E-beam irradiated PLA after 6 weeks in compost: (a) 0 kGy, (b) 72 kGy, (c) 144 kGy, (d) 216kGy



Figure 2-12. Structural integrity of e-beam irradiated/composted PLA: (a) early cracks affecting surface, (b) layer formation and overall structure affected

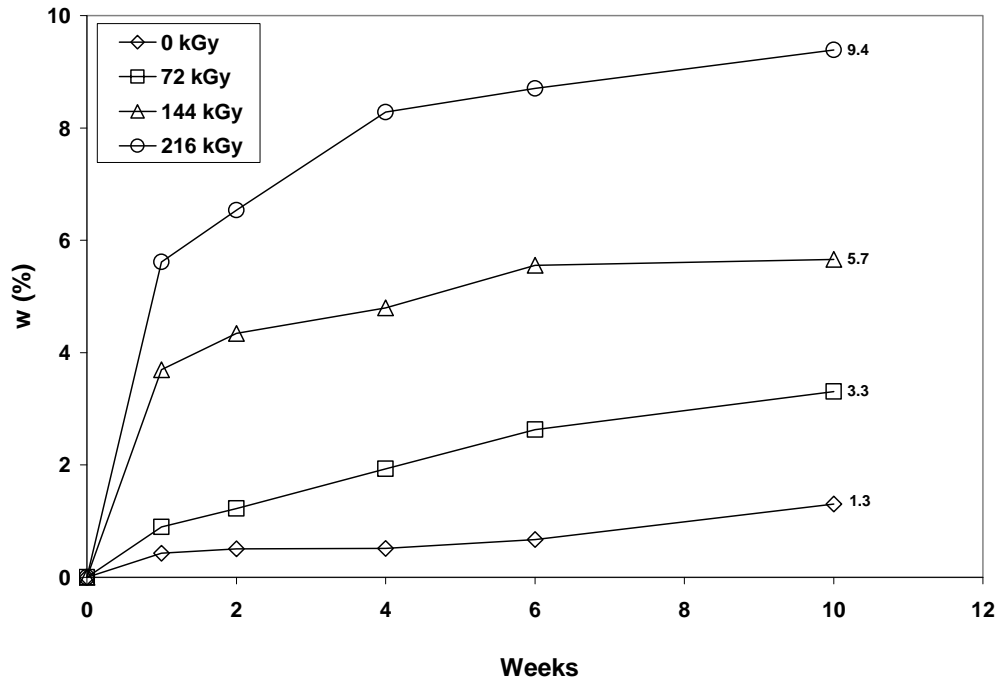

Figure 2-13. Weight loss of e-beam irradiated/composted PLA

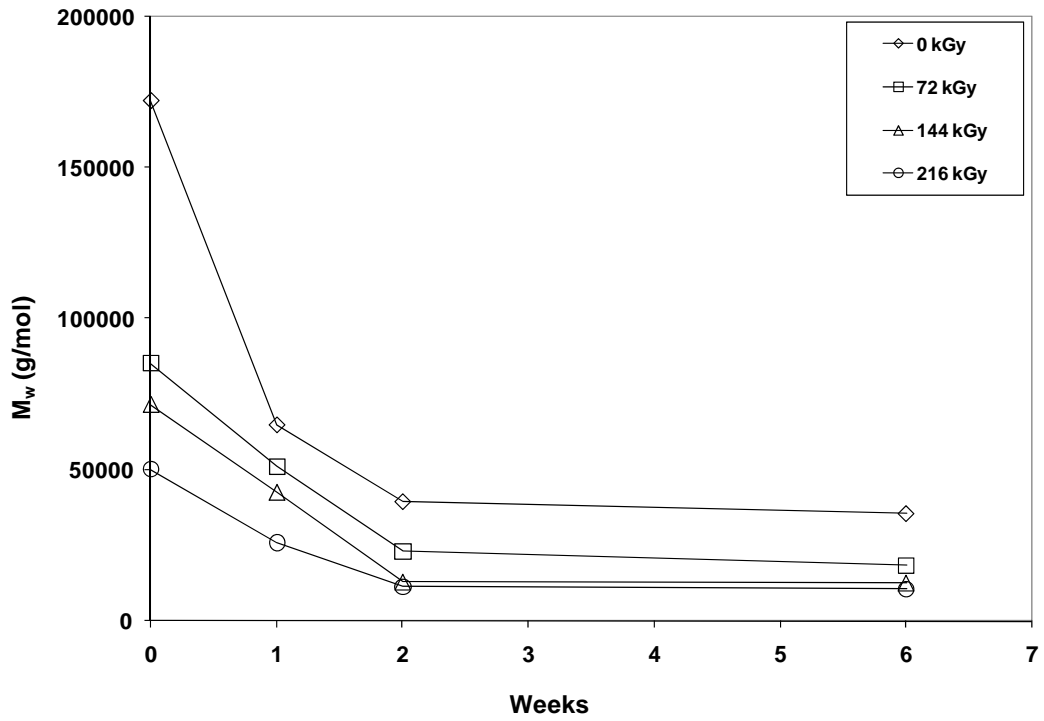

Figure 2-14. Molecular weight of e-beam irradiated/composted PLA

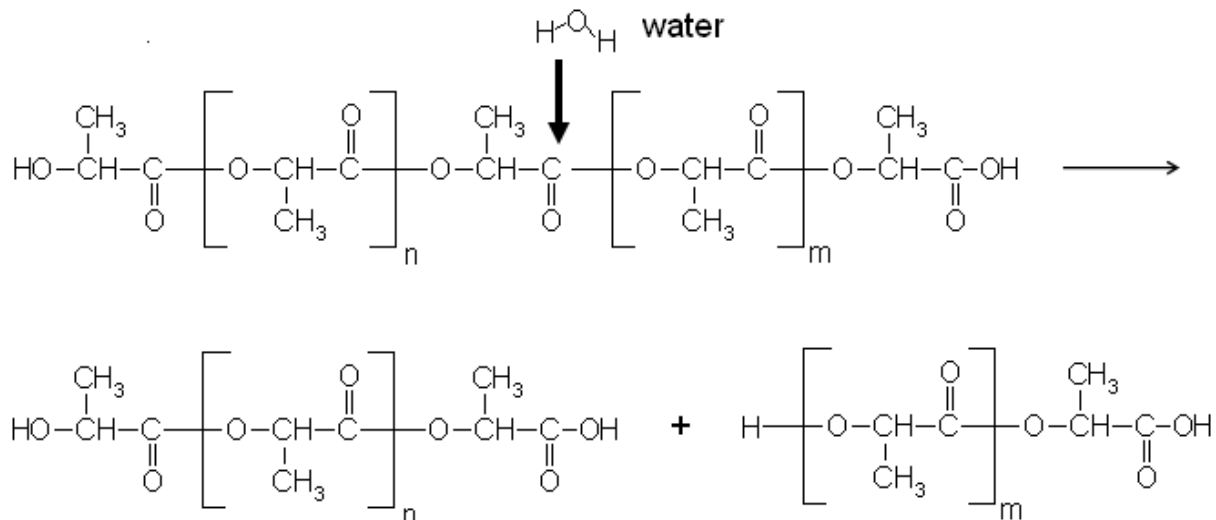

Figure 2-15. Hydrolysis of PLA.

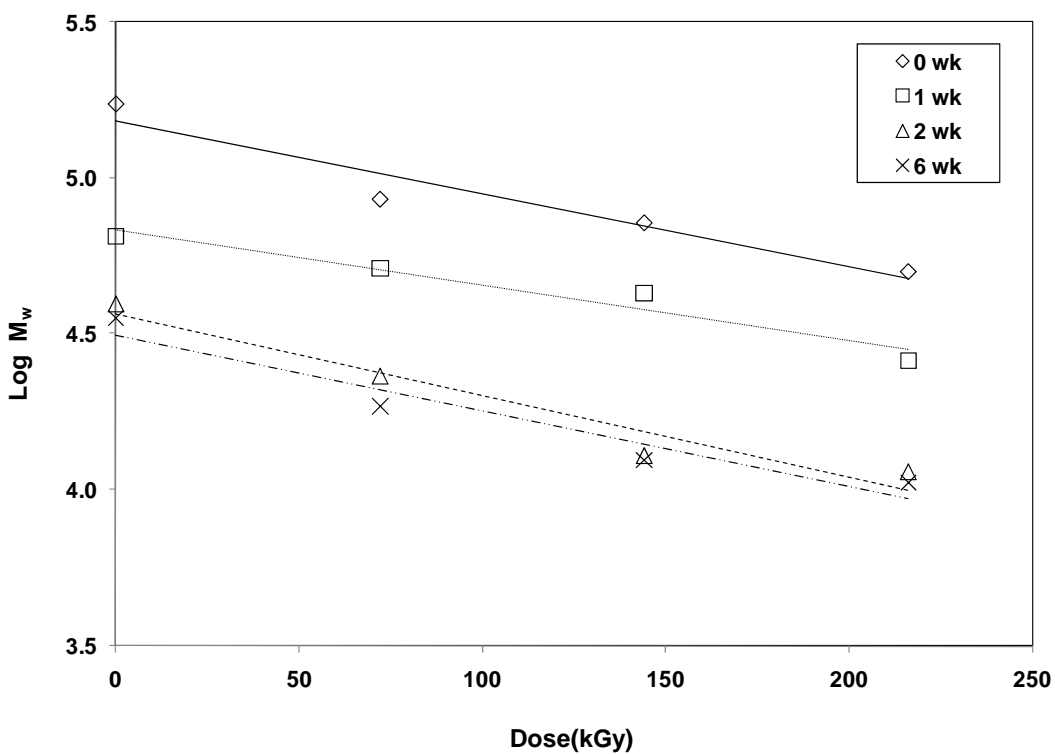

Figure 2-16. Plots of e-beam irradiation dose vs. $\log M_w$ for D-values estimation

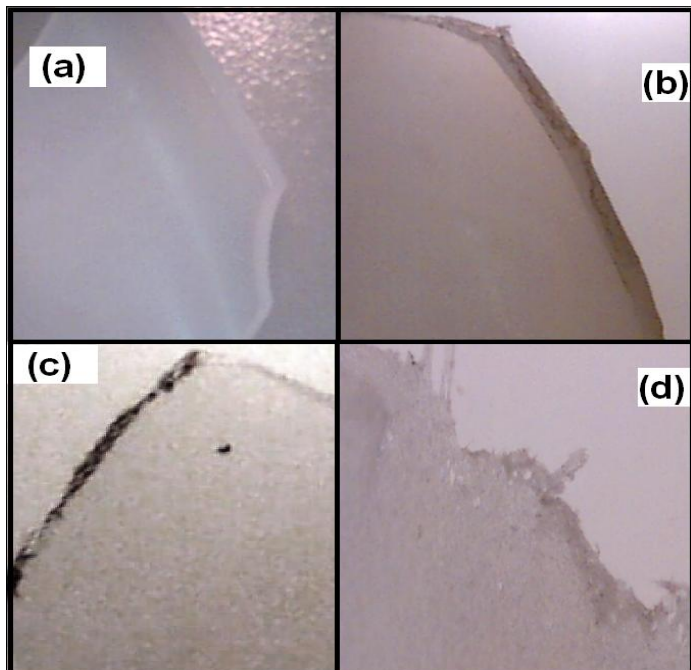

Figure 2-17. Structural integrity of PLA subjected to alkaline media: (a) 0.1N 2d, (b) 0.1N 22d, (c) 1N 6d, (d) 1N 13d

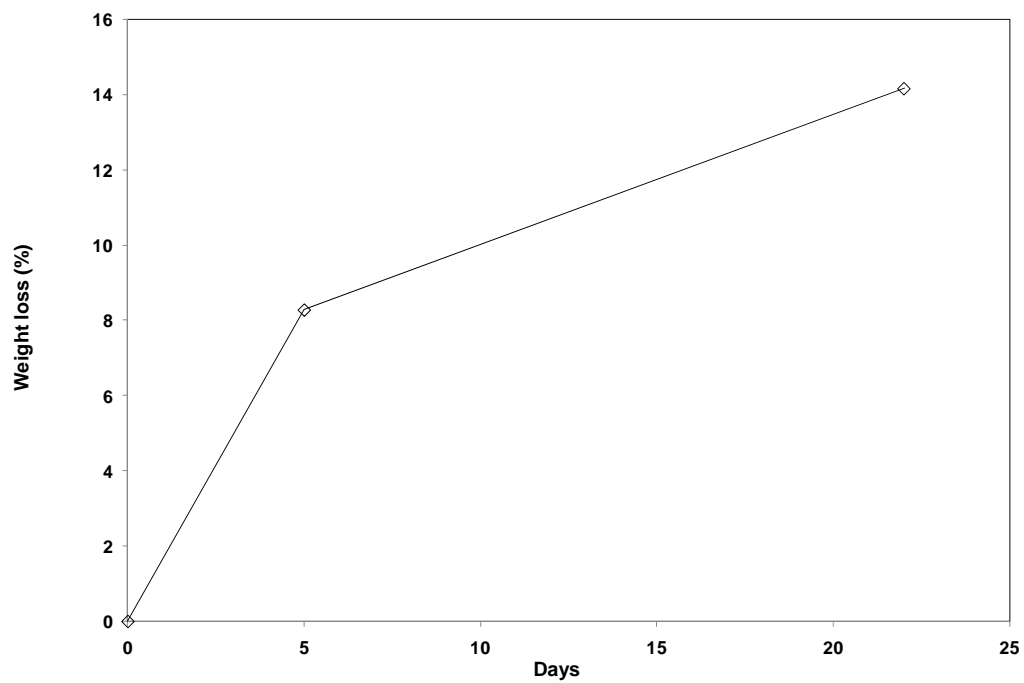

Figure 2-18. Weight loss of PLA subjected to 0.1N NaOH

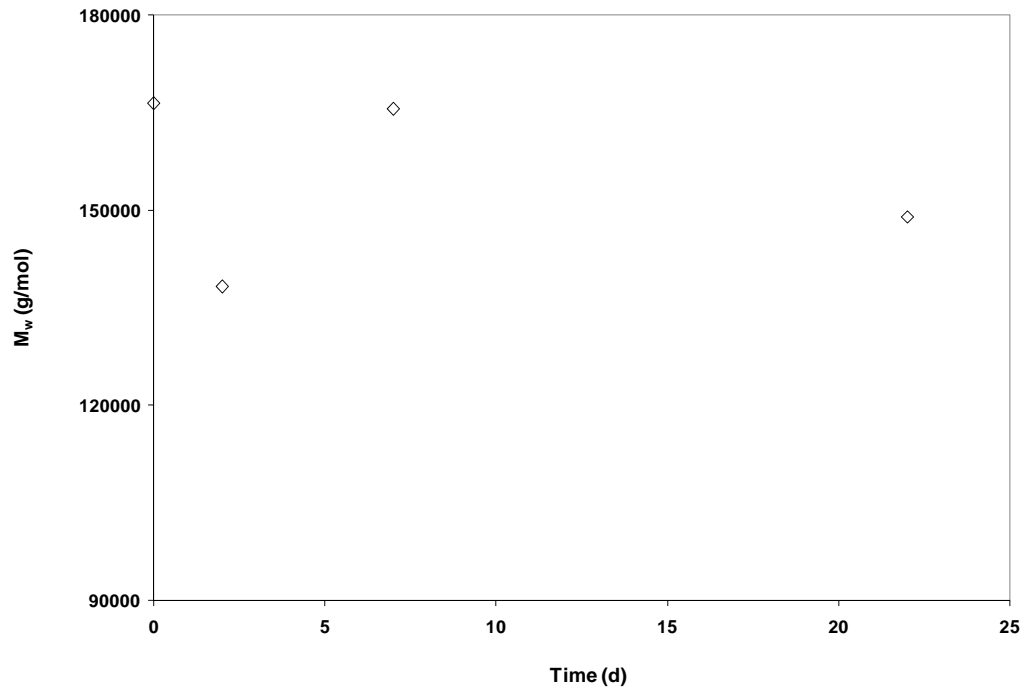

Figure 2-19. Molecular weight of PLA subjected to alkaline media

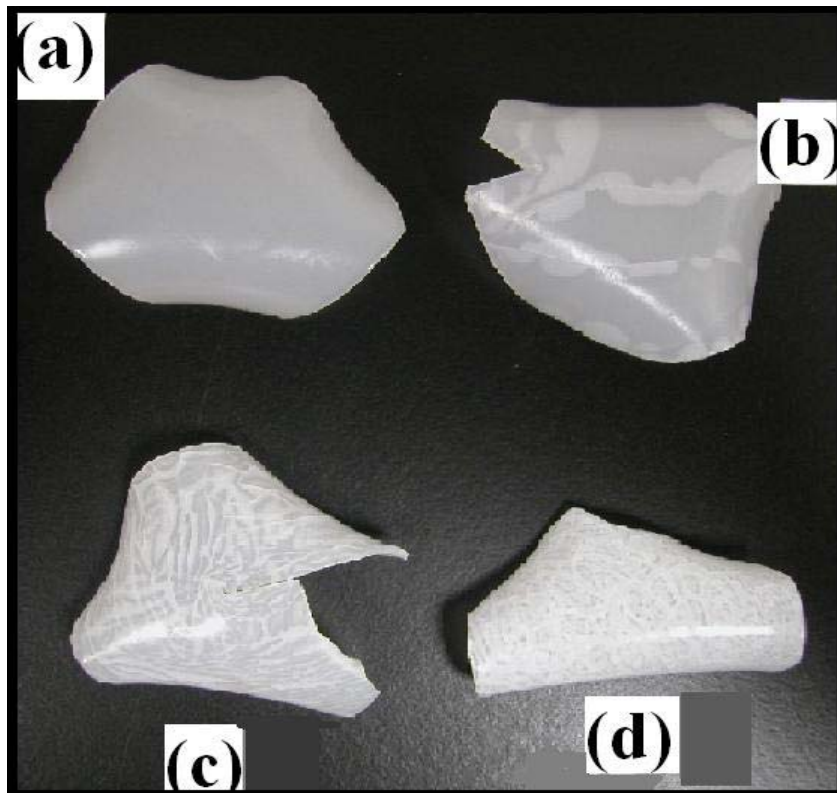

Figure 2-20. Structural integrity of steam-treated PLA: (a)100°C-4h, (b)110°C-4h, (c)100°C-8h, (d)110°C-8h

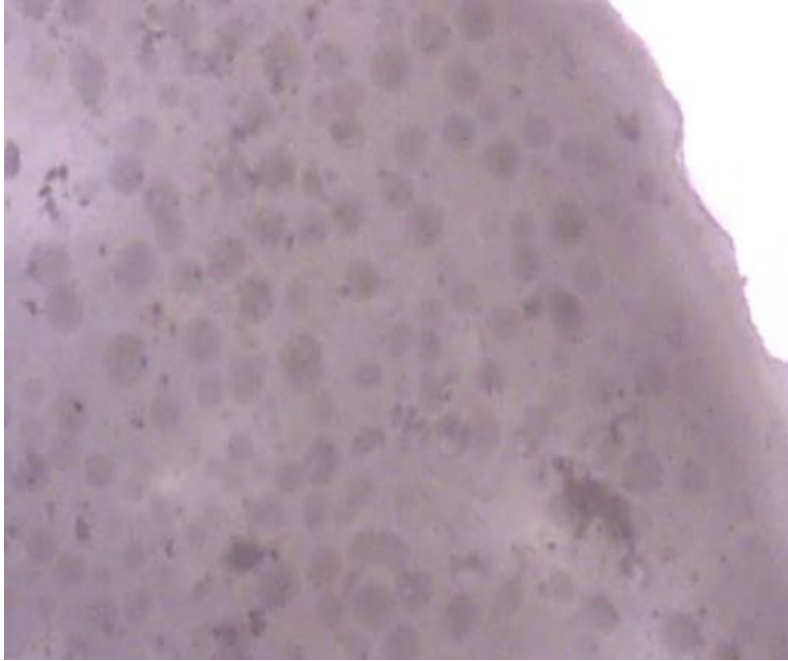

Figure 2-21. Pores in steam-treated PLA: 120°C–8h (×60)

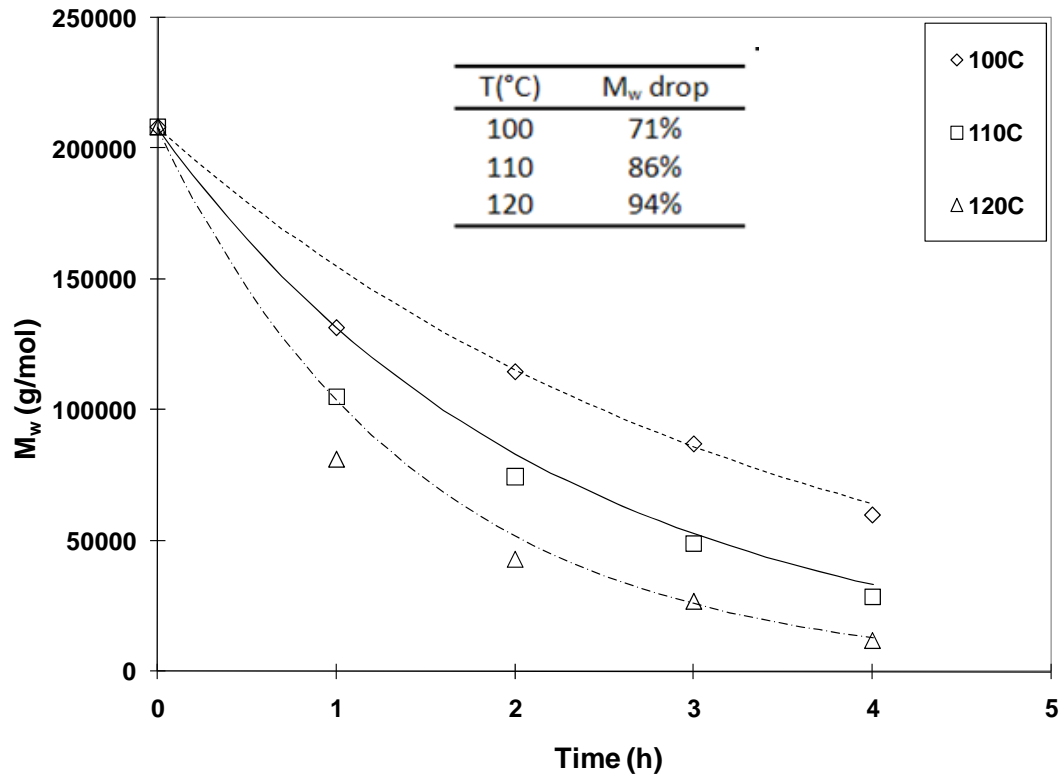

Figure 2-22. Molecular weight of steam-treated PLA

Table 2-1. Linear regression outputs and D-values of e-beam irradiated/composted PLA

	0 wk	1 wk	2 wk	6 wk
R-square	0.9322	0.9481	0.9426	0.9328
Slope	-0.0023	-0.0018	-0.0026	-0.0024
D-value	427	564	384	412

Table 2-2. Comparison of treatments to reduce PLA molecular weight

Treatment	M_w reduction	Conditions	Availability (max 5)
Gamma irradiation	86±2%	172 kGy	+
E-beam irradiation	65±9%	216 kGy	+
Alkaline hydrolysis	<10%	NaOH 0.1N x 22d	+++++
Acid hydrolysis	NA	HNO3 0.1% x 22d	+++++
Steam	94%	120°C x 4h	+++

CHAPTER 3 KINETICS OF REDUCTION OF MOLECULAR WEIGHT IN STEAM-TREATED PLA

Introduction

In the previous chapter, it was demonstrated that exposure of PLA to steam is the most effective treatment to reduce molecular weight. This chapter covers kinetics of reduction of molecular weight in steam-treated PLA. A first-order reaction model was proposed. This mathematical estimation would allow relating molecular weight with steam temperature and exposure time.

In addition, this chapter confirms that steam affects PLA through hydrolysis. Analysis of spectroscopy by Fourier Transform Infrared - Attenuated Total Reflectance (FTIR-ATR) confirms depolymerization back to lactic acid.

Methods

First Order Reaction Model

Molecular weight loss of PLA treated with steam at 100, 110 and 120°C was assessed using first order kinetics. The mathematical model follows Equation 3-1 where k_T is the reaction rate constant at temperature T , and M is the molecular weight at time, t .

$$\frac{dM}{dt} = -k_T M \quad (3-1)$$

Solving the ordinary differential equation with limits $t = 0$ to t , and $M = M_o$ to M , results in Equation 3-2:

$$M = M_o e^{-k_T t} \quad (3-2)$$

Kinetic constants, k_T , were found to be correlated with absolute steam temperatures, T , in accordance to the Arrhenius behavior [39] shown in Equation 3-3. Activation energy, E_a , and pre-exponential factor, k_o , were estimated by linearization.

$$k_T = k_o \exp\left(-\frac{E_a}{RT}\right) \quad (3-3)$$

A final model for molecular weight of PLA, which is temperature and time dependent, is shown in Equation 3-4. This model allows prediction of molecular weight, M , of PLA with initial molecular weight, M_o , after exposure to steam at temperature, T , after time, t .

$$M = M_o \exp(-k_T t) = M_o \exp\left(-k_o t \exp\left(-\frac{E_a}{RT}\right)\right) \quad (3-4)$$

Depolymerization of PLA to Lactic Acid Resulting from Steam Exposure

An experiment was conducted in order to confirm that exposure of PLA to steam undergoes hydrolysis until complete depolymerization to lactic acid units. For this purpose, an extreme treatment of 120°C for 24 hours was performed. In this experiment, PLA samples (~30.1g) were placed in jars (holed lids) containing 100ml of deionized water (pH 7.5) and then retorted.

After steam treatment, jars contained residual solid PLA and a liquid drip, probably condensed water plus a byproduct from PLA. Drip was collected and analyzed by pH (Accumet® AR60, Fischer Scientific, Pittsburgh, PA) and FTIR-ATR (Nicomet 6700 Smart Orbit, Thermo Scientific, Inc) to confirm presence of lactic acid. Also, the yield of PLA conversion to its monomer lactic acid was determined (Equation 3-5). Variables W_o and W_f are PLA dry solid weights before and after the steam exposure for 24 hours. The term $(W_o - W_f)$ represents the weight of PLA that was converted to lactic acid.

$$\% \text{ conversion} = \frac{W_o - W_f}{W_o} \times 100\% \quad (3-5)$$

Results and Discussion

First-order Reaction Model

Figure 3-1 shows semi-log plots of molecular weight vs. time at 100, 110 and 120°C. Slopes of curves, obtained by regression analysis, represent the respective kinetic constants, k_T , and are shown in Table 3-1.

Figure 3-2 shows temperature sensitivity of the reaction rate constants, k_T , through the Arrhenius plot. Regression provides estimates for activation energy, E_a , and Arrhenius pre-exponential factor, k_o . Regression analysis yields an r-square of 0.996. Values for E_a and k_o were 52.3 KJ/mol and $-6.18 \times 10^6 \text{ h}^{-1}$. Other authors have found E_a of 51 KJ/mol for poly(L-lactic acid) (PLLA) in the melt at 180-250°C [39] and 233 KJ/mol for PET in the melt at 250-280°C [40]. This shows that activation energy for reduction of PLA molecular weight is much lower than that of PET, but similar to that for PLLA in a melt at higher temperatures. These values were used in Equation 3-4 to predict molecular weight reductions shown earlier in Figure 2-22. Figure 2-22 shows experimental and model predicted values.

Depolymerization of PLA to Lactic Acid Resulting from Steam Exposure

After exposure of PLA samples to steam at 120°C for 24 hours, the solid mass was significantly reduced. This reduction suggested PLA conversion to a water-soluble compound in solution with condensed steam. Liquid in the jar (drip) had a pH of about 1.5 indicating presence of acid, most probably lactic acid. Finally, results of FTIR-ATR confirmed that the liquid by-product was lactic acid. Figure 3-3 shows spectra for lactic acid from PLA and of DL-lactic acid control (Acros Organics, Geel, Belgium). These spectra appear to confirm liberation of lactic acid during steam treatment.

As seen in the mass balance shown in Figure 3-4, weight of PLA decreased from 30.1g to 4.6g after this treatment. This represents a percentage of weight loss of 84.7% where a

significant part converted to lactic acid units. Tsuji et al. (2003) studied melt hydrolysis of PLA and found a yield of L-lactic acid from PLLA of 90% at 250°C for 10-20 minutes [39]. Ohkita and Lee (2006) investigated the enzymatic hydrolysis of PLA using proteinase K and found a yield of lactic acid from PLA of 38% after 8 days at 37°C [8]. Based on weight loss of PLA, it is presumable that yields of lactic acid here were not much different from those observed by hydrolysis in the melt.

Conclusion

It has been demonstrated that exposure to steam up to 120°C is an excellent method to hydrolyze PLA. Treated samples became brittle and riddled with pores, and analysis performed by FTIR-ATR confirmed hydrolytic liberation of lactic acid to the treatment medium. Weight loss of PLA after 24 hours in steam at 120°C was 84.7% and suggests significant conversion to lactic acid.

A kinetic model describing molecular weight reduction in PLA as a consequence of hydrolytic steam treatments was presented. Degradation followed first order kinetics with activation energy, E_a , of 52.3 KJ/mol. Predicted values fitted experimental data well. Availability of this model is very important because, if it is demonstrated that steam-treated PLA is affected under composting conditions, additional models may be developed to predict biodegradation behavior as a function of the steam-treatment conditions. These simulations will ultimately be useful for optimizing the whole two-step process (pre-treatment and composting).

Finally, this study shows that steam treatments may be suitable not only for making PLA waste more accommodating to commercial composting operations, but also, for assisting with separation of PLA from traditional plastic wastes.

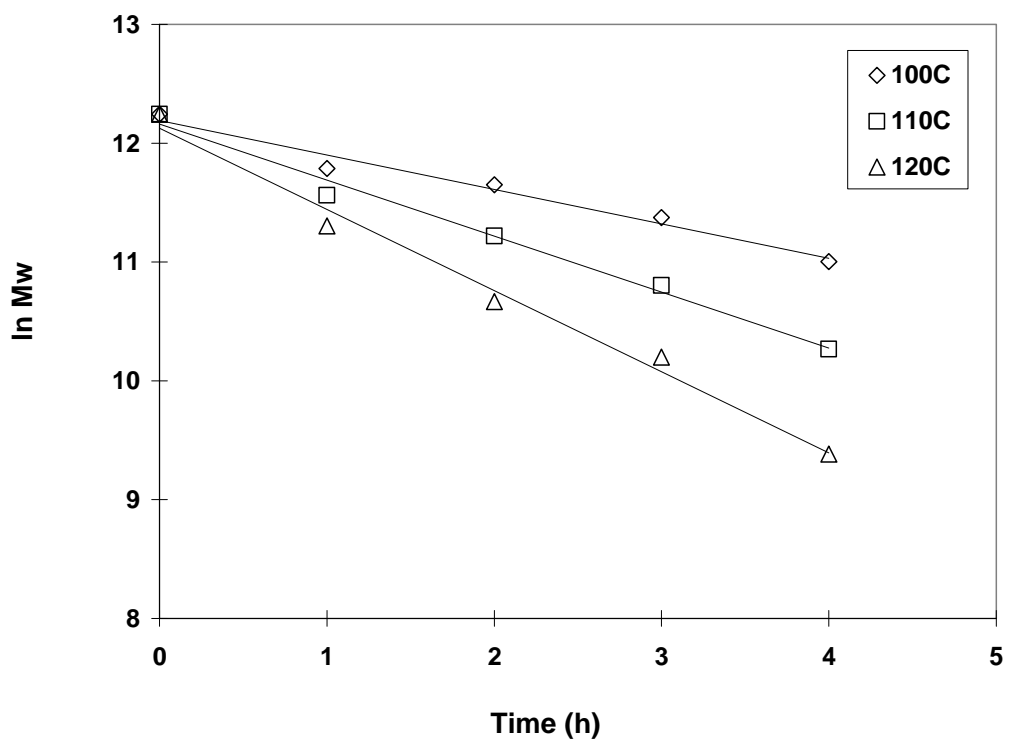

Figure 3-1. First-order reaction plots for steam-treated PLA

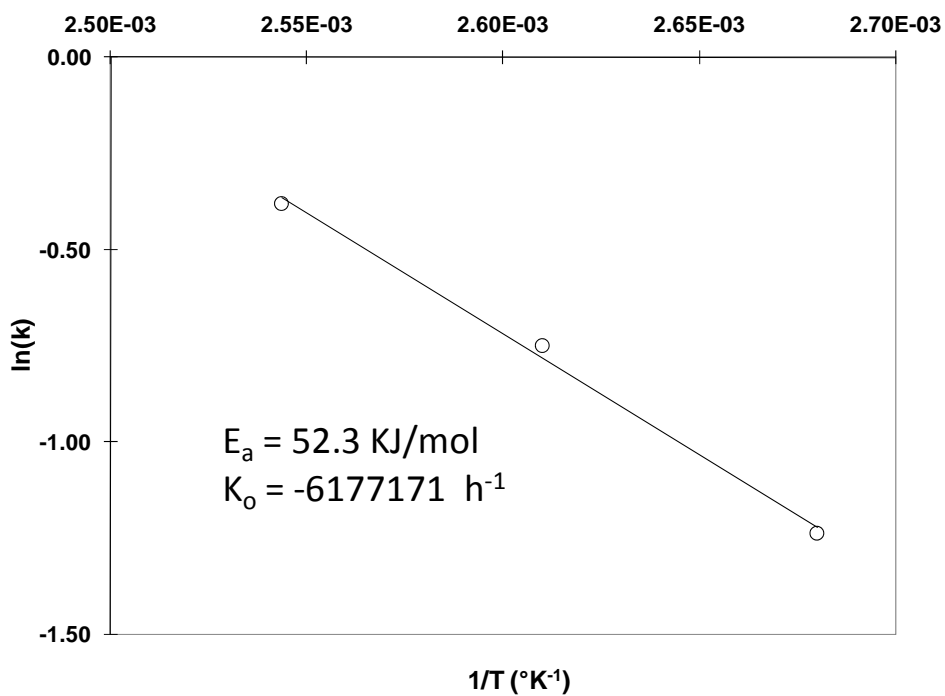

Figure 3-2. Arrhenius plot for steam-treated PLA

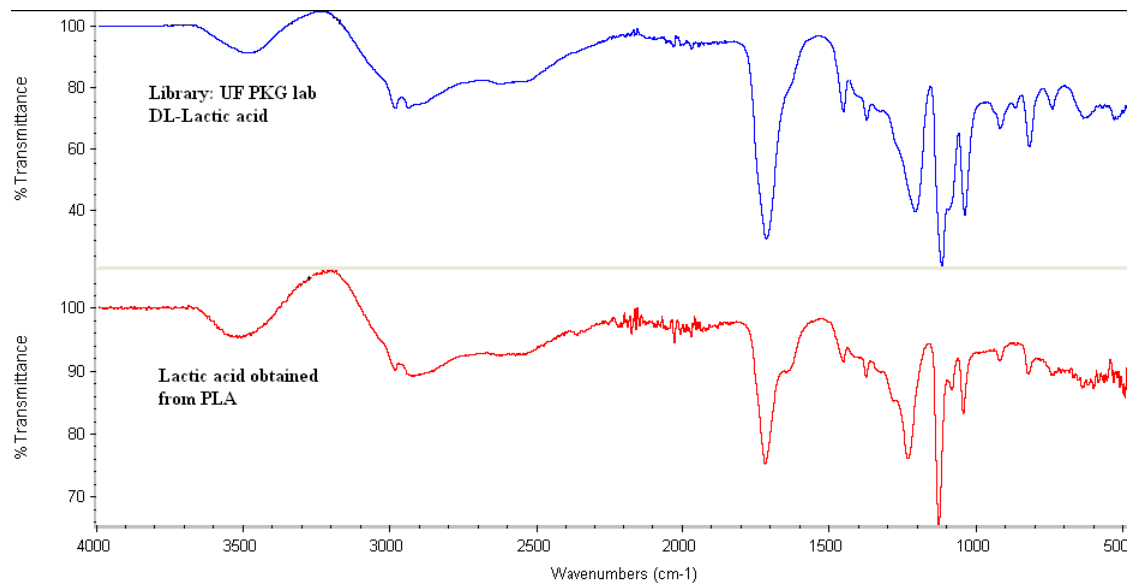

Figure 3-3. Spectra of lactic acid obtained by FTIR-ATR

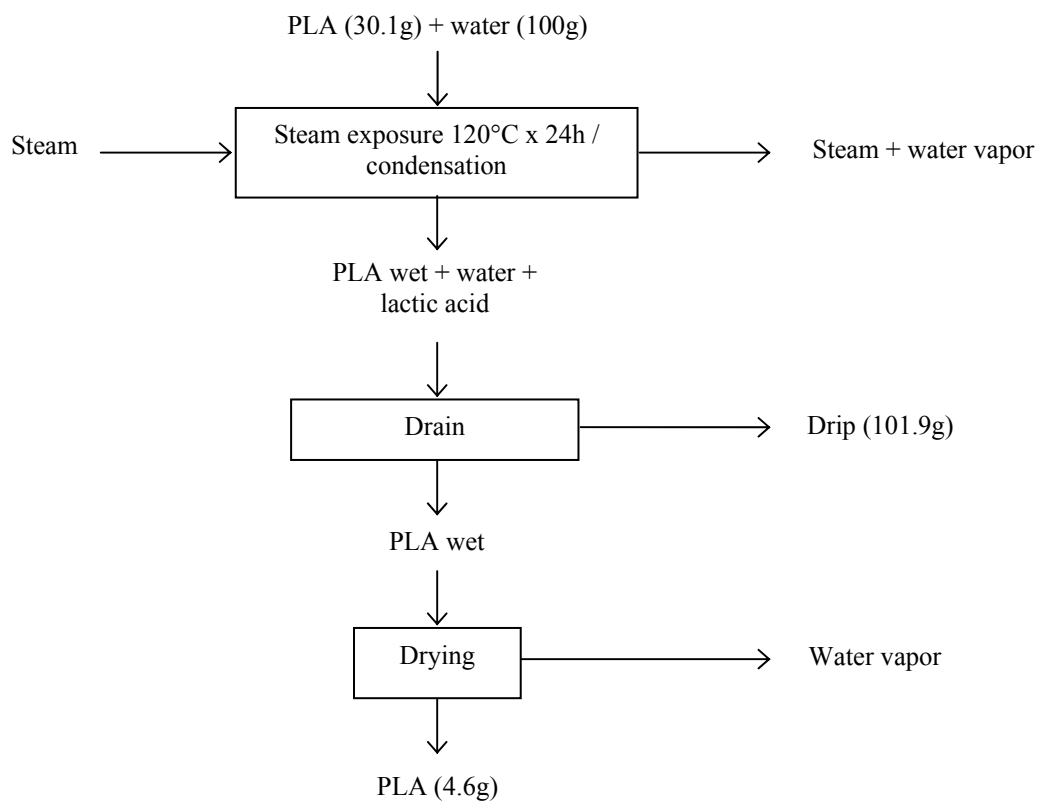

Figure 3-4. Mass balance of PLA treated with steam at extreme conditions

Table 3-1. Reaction rate constants, k (h^{-1}), for molecular weight reductions of steam-treated PLA

	Temperature ($^{\circ}\text{C}$)		
	100	110	120
k	0.290	0.470	0.680
r^2	0.975	0.989	0.988

CHAPTER 4
DEVELOPMENT OF METHODS TO EVALUATE AEROBIC BIODEGRADATION OF PLA

Introduction

The following standards are available for determining aerobic biodegradation of plastic materials under controlled composting conditions:

American Society for Testing and Materials: ASTM D5338

International Standards Organization: ISO 14855

These methods require mounting complicated systems involving temperature controlled vessels connected to permanent supply of oxygen and water vapor. Proposed vessels are too big (2-5 L) and temperature profiles are generated, providing variability in conditions inside the bulk. Additionally, heat generation can vary depending on compost weight and composition, which may also contribute to uneven temperature profiles. Figure 4-1 shows a diagram of the system configuration for ASTM D5338 [40], and it is required oxygen tanks, humidifiers, gas chromatographs, and baths / big ovens/ heaters. These issues, combined with monitoring duties, makes this method not practical for rapid biodegradation assessments. A simpler approach would be desirable. This chapter investigates new ways to determine evolution of aerobic biodegradation instead of using standard methods.

Aerobic biodegradation of PLA is measured by the ratio of carbon evolved as carbon dioxide (released during breakdown), over initial carbon content. Mathematically, it can be expressed as Equation 4-1.

$$\% \text{ biodegradation} = \frac{\text{Mass of carbon in evolved } CO_2}{\text{Mass of carbon in initial PLA}} \times 100\% \quad (4-1)$$

If none of the carbon atoms in PLA molecules converts to carbon in the generated CO_2 , biodegradation would be zero. In contrast, if all carbon is converted to CO_2 , then biodegradation would be 100%. Some carbon is believed to be converted to bicarbonates and carbonic acid, and

other components may recombine with the humic acids present in the compost. Also, carbon from PLA may be assimilated into microbial biomass. However, production of CO₂ is the basis of biodegradation assessments. Therefore, the capability of quantifying evolved CO₂ from the system is critical to any method developed to quantify biodegradation.

In this chapter, three methods are designed, developed and assessed to measure PLA biodegradation evolution, including (1) the method of flexible bags, (2) the method of rigid containers, and (3) the method of perforated jars. The first two rely on principles of modified atmosphere packaging (MAP) and estimate CO₂ production by combining a system molar balance and equations that govern gas permeability through plastic films. The third method relies on principles of gas diffusion and estimate CO₂ production by combining a system molar balance and CO₂ diffusion through holes in jars.

Materials and Methods

Method of Flexible Bags

This method was proposed as a modification of the standard method ASTM D5338 [41] to overcome the issue of requiring permanent oxygen and water vapor supply. The use of a highly permeable film would permit oxygen transmission into the bag while withholding moisture content of the biomass. Thus, selection of the film is critical for this method. Ideally, this method requires a film that is very permeable to oxygen, impermeable to water vapor, and semi-permeable to carbon dioxide. Unfortunately, no commercially available films meet these requirements, however high oxygen transmission rate (OTR) polyethylene was the closest to the requirements of this method, so it was used.

Polyethylene film (Cryovac, Duncan SC) of 3.035mil thickness with high oxygen transmission rate (9224 cc m⁻²d⁻¹ @ 25°C) was used to prepare bags with dimensions 9cm x 12cm. A thermosealer (Sencorp Systems model 12SC/1) was used for sealing edges. Rubber

pads (sticky nickels, Mocon, Inc., Minneapolis, MN) were glued on their surfaces to serve as syringe needle ports injecting water or taking gas samples from the headspace. Bags were filled with 40g of 3-month mature compost (Appendix A) and 8g of PLA. Control bags included only 40 g of compost. Filled and sealed bags were stored in a Lab-Line[®] L-C Incubator (Lab-Line Instruments, Inc., Melrose Park, IL) at 58°C for 40 days. Figure 4-2 shows a diagram of the flexible bags and the main interactions between the biomass (compost + PLA), the headspace and the environment, and pictures can be seen in Figure 4-3.

Periodically, bags were agitated, water was injected (~1-3ml) and gas samples from the headspace were taken for analysis. Headspace gas analysis was performed using a dual headspace analyzer (Pac Check[®] 650, Mocon, Inc., Minneapolis, MN) to determine carbon dioxide and oxygen concentration over time. A molar balance of carbon dioxide in the system is expressed in Equation 4-2. Oxygen and nitrogen concentrations were not used for this method since they are not a carbon source.

$$\eta CO_2 \text{ generated} = \eta CO_2 \text{ permeated} + \eta CO_2 \text{ headspace} \quad (4-2)$$

The number of moles permeated can be estimated by Equation 4-3, derived from the definition of permeability [42].

$$\eta CO_2 \text{ permeated} = \frac{P_{CO_2} A p_{CO_2} \Delta t}{E} = \frac{P_{CO_2} A [CO_2] p_{atm} \Delta t}{E} \quad (4-3)$$

The number of moles in the headspace can be estimated by Equation 4-4, derived from the universal gas law [43].

$$\eta CO_2 \text{ headspace} = \frac{p_{CO_2} V_{hs}}{RT} = \frac{p_{atm} [CO_2] V_{hs}}{RT} \quad (4-4)$$

Film permeability to carbon dioxide, P_{CO_2} , at 58°C was estimated using the methodology described in Appendix B and was equal to 13.41 mol.mil / (atm.d.m²). The volume of the headspace, V_{hs} , was estimated by subtracting the volume occupied by the compacted biomass (Appendix C) to the bag volume (Appendix D) which was measured with a volume-meter designed and constructed for this purpose.

Production of CO₂ solely from PLA is the difference between CO₂ produced from the mixture PLA-compost and CO₂ produced by the compost itself (control). Once it is known how many moles of CO₂ are due to PLA, the carbon mass can be determined by multiplying the number of moles by 12 which is the molecular weight of carbon. Finally, total biodegradation is the ratio of carbon mass evolved as CO₂ to initial carbon mass in PLA sample assessed. Weight of carbon in PLA is half its total weight (Figure 4-4).

To organize and simplify calculations, Table 4-1 was developed. Plots of columns (1) and (10) provide PLA biodegradation.

Method of Rigid Containers with Plastic Film Lids

A cylindrical, rigid, wide mouth container with 2850cc capacity was adapted with ports, filled with 100g of 4-month mature compost (Appendix A) and 10g of PLA. Control was filled with only 100g of compost. Mouths of containers, with internal diameters of 15cm, were covered with high OTR polyethylene film (Cryovac, Duncan SC) (thickness ~3.035mil, OTR ~9224 cc/(m².d) @ 25°C) that served as the material to allow O₂ and CO₂ permeation. Containers were stored in a Lab-Line[®] L-C Incubator (Lab-Line Instruments, Inc., Melrose Park, IL) at 58°C for 18 days. Figure 4-5 shows a diagram of the rigid containers with plastic lids, as well as the main interactions between biomass (compost + PLA), headspace and environment. A picture of the system is shown in Figure 4-6.

Daily, containers were agitated, water was injected to maintain proper moisture (~45-55%), and gas samples from the headspace were taken for analysis. Also, for better performance, oxygen was injected daily (~100 – 300cc) to maintain aerobic conditions. The headspace was analyzed in a dual headspace analyzer (Pac Check[®] 650, Mocon, Inc., Minneapolis, MN) to determine carbon dioxide and oxygen concentrations.

Over time, data for carbon dioxide concentration in the headspace were collected. As in the method of flexible bags, the number of moles of CO₂ generated by the biomass is the sum of the moles permeated out of the container and the moles in the headspace. Expressions that govern each component of this molar balance are Equation 4-3 and Equation 4-4 but with the new data from this experiment. Thus, Table 4-1 was also used to process these data and plots of columns **(1)** and **(10)** provided evolution of PLA biodegradation assessments.

Method of Perforated Jars

Glass mason jars of 936cc of capacity were filled with 100g of 5-month mature compost (Appendix A) and 10g of PLA. Controls were filled with only 100g of compost. Lids were drilled with five 1/16” holes to allow gas transfer between the environment and jars headspace. Closed jars were stored in a Lab-Line[®] L-C Incubator (Lab-Line Instruments, Inc., Melrose Park, IL) at 58°C for 34 days. Figure 4-7 shows the diagram of perforated jars and the main interactions between biomass (compost + PLA), headspace and environment. Pictures of a jar filled with 1-week biomass and arrangement of 5-holes is shown in Figure 4-8.

Daily, jars were agitated and concentration of oxygen and carbon dioxide in the headspace were determined using a dual headspace analyzer (Pac Check[®] 650, Mocon, Inc., Minneapolis, MN). Periodically, water (~2-4cc) was added through the holes to compensate for water loss. A molar balance of carbon dioxide in the system is as follows (Equation 4-5):

$$\eta CO_2 \text{ generated} = \eta CO_2 \text{ diffused} + \eta CO_2 \text{ headspace} \quad (4-5)$$

The number of moles, η , diffused represents the average of moles flowing through the holes. This value can be estimated by Equation 4-6, derived from Fick's first law that states that the flux or rate of transport of an ideal gas is linearly related to its concentration gradient [42].

$$\eta CO_2 \text{ diffused} = D_{ef} [CO_2] \Delta t \quad (4-6)$$

The number of moles in the headspace can be estimated by Equation 4-7 which is derived from the universal gas law [43].

$$\eta CO_2 \text{ headspace} = \frac{P_{CO_2} V_{hs}}{RT} = \frac{P_{atm} [CO_2] V_{hs}}{RT} \quad (4-7)$$

The overall coefficient of diffusion, D_{ef} , was determined in a parallel experiment (Appendix E). The volume of the headspace was estimated by subtracting the volume occupied by the biomass (Appendix C) from the total volume of the jars which was 936cc.

Production of CO_2 solely from PLA is the difference between CO_2 produced from the mixture PLA-compost and CO_2 produced from the compost itself (control). The carbon mass can be determined by multiplying the number of moles of CO_2 produced by 12, which is the molecular weight of carbon. Finally, total biodegradation is the ratio of carbon mass evolved as CO_2 to initial carbon mass of PLA samples assessed. Initial weight of carbon in PLA samples is half the sample weight based on the molecular formula of PLA.

To organize and simplify calculations, Table 4-2 can be completed. Plots of columns (1) and (10) provide PLA biodegradation.

Results and Discussions

Method of Flexible Bags

The method of flexible bags was developed to simplify analysis of biodegradation behavior. Ideally, this method could eliminate the need for continuous gas flow and moisture

management. To sustain aerobic composting conditions the film requires high OTR characteristics. The film chosen has the highest OTR of any readily available commercial film. At composting conditions, the film proved to be too fragile to manipulate. Additionally, the film's water vapor transmission rate (WVTR) proved to be higher than desirable for this application. However, the theory supporting the approach is sound and this analysis and summary are provided as a means for suggesting future work if and when a better film becomes available. Main issues encountered during the experiment performed with the method of flexible bags follow:

- Moisture loss and related punctures: Water vapor permeated out of the bag faster than expected, so moisture content of biomass dropped quickly. This problem was solved by injecting water into bags more frequently, but this required additional punctures and resultant leaks.
- Abrasion of film: Shaking of the bags, intended to homogenize internal conditions (oxygen supply, heat and moisture), caused abrasion and damage to the film. This may have created small holes and leaks that were not visible.
- Strength loss of film: Formation of by-products from PLA biodegradation (i.e. lactic acid) reduced the pH of the biomass, and in concurrence with temperature and high relative humidity, deteriorated the film surface. Film developed a burn-like appearance and lost strength. Modification of film properties could affect permeability of the film to CO₂.
- Oxygen depletion: When biological activity began to take place, samples started to show elevated rates of oxygen consumption. This fact depleted the oxygen supply in the headspace and turned the process anaerobic. ASTM D5338 recommends oxygen levels above 6% for ensure aerobic conditions [41], and some of the experiments got 0% oxygen. This issue could have been overcome by increasing the film area. However, something unexpected was found; even without oxygen, CO₂ generation still increased. This suggests that facultative microorganisms were active and may have been responsible for biological activity with or without oxygen. Figure 4-9 shows a picture of a bag in its day 40th that after many days under anaerobic conditions, showed total disappearance of PLA.

Results of untreated PLA biodegradation, obtained using this method, are shown in Figure 4-10. Large standard deviations were found among the 5 replications performed. For example, after 40 days one sample was 7.5% biodegraded whereas another was 30.3%. This disparity was

primarily due to issues related to the film used. Thus, this method using currently available high permeation film is not sufficiently reliable.

Method of Rigid Containers with Plastic Film Lids

The method of rigid containers with plastic film lids was designed to overcome the issues encountered in the method of flexible bags. The design involved ports attached to the walls of the rigid container in order to avoid damaging the delicate film. Also, since the plastic film served as the container's lid (did not contact the biomass), abrasion and strength loss issues were eliminated. To avoid oxygen and water vapor depletion, gases were injected daily to maintain required ranges (O_2 between 10-21%, moisture between 45-60%).

An unavoidable issue was the plastic lid deformation caused by the water vapor pressure, and its consequent effect in the permeability estimation. Deformation of the plastic film lid was measured and estimated to add 5%.

After 18 days in rigid containers with plastic film lids, PLA biodegradation was estimated to be 10.1% as seen in Figure 4-11. As with experiments of the flexible bags, the trend was almost constant during the first week and then increased at a constant rate. It is believed that in the presence of PLA, microorganisms slow down biological activity in the surrounding organic matter (compost) in order to adapt to the new source of carbon.

This method overcomes most of the issues encountered in the method of flexible bags, but still left room for improvement. Remaining issues are that CO_2 permeability may be affected by water vapor as well as issues with variable geometry due to stretching. These observations led to a new method that avoided plastic film.

Method of Perforated Jars

The method of perforated jars did not present the issues encountered in previous developed methods. The problems of area, volume and leaking of the system were eliminated by the rigidity

of the container, and water vapor pressure effects were avoided by presence of holes. The holes served not only to allow mass transfer (O_2 , CO_2), but also to inject water or take gas sample from the headspace. The overall effective coefficient of diffusion (5 holes) for CO_2 was found to be $D_{ef} = 0.00031$ mol/h/% and was estimated by the slope of the plot of experimental calculated effusion rate vs. % CO_2 shown in Figure 4-12. The r-square value obtained by linear regression analysis was found to be practically 1, indicating an almost perfect linear dependence of effusion rate with CO_2 concentration inside the jar, as expected.

In Figure 4-13, PLA biodegradation was obtained for a remaining solid sample (no drip) that was exposed to steam at $100^\circ C$ for 4 hours. Higher rates of biodegradation were observed in these samples compared with those of untreated samples assessed using the method of rigid containers with plastic film lids.

Conclusion

Among the methods developed and assessed to perform PLA biodegradation, the method of perforated jars was found to be the most reliable and simple. It does not require mounting a system as the one proposed in the standards (ASTM D5338 and ISO 14855) that need permanent oxygen and water vapor supply. This method is much easier to conduct and adapt. For example, if it is expected that biological consumption of oxygen will be much faster, more holes could be added. The only drawback of this method is the requirement to inject water about every two days to maintain moisture content in the proper range. In this regard, a recommendation could be integration of a water dispenser to the jars in order to recover water released through holes as water vapor.

The method of flexible bags and rigid containers with plastic film lids had too many issues, the most significant being the possible alteration of the film due to high relative humidity, temperature and vapor pressure in the system. This issue can be overcome by determining a

dynamic permeability coefficient of the film to carbon dioxide, which would be a function of temperature, and relative humidity and vapor pressure as well. Identifying a film that fulfills requirements of gas transmission rates (CO_2 , O_2 and WVTR) is also difficult at this time.

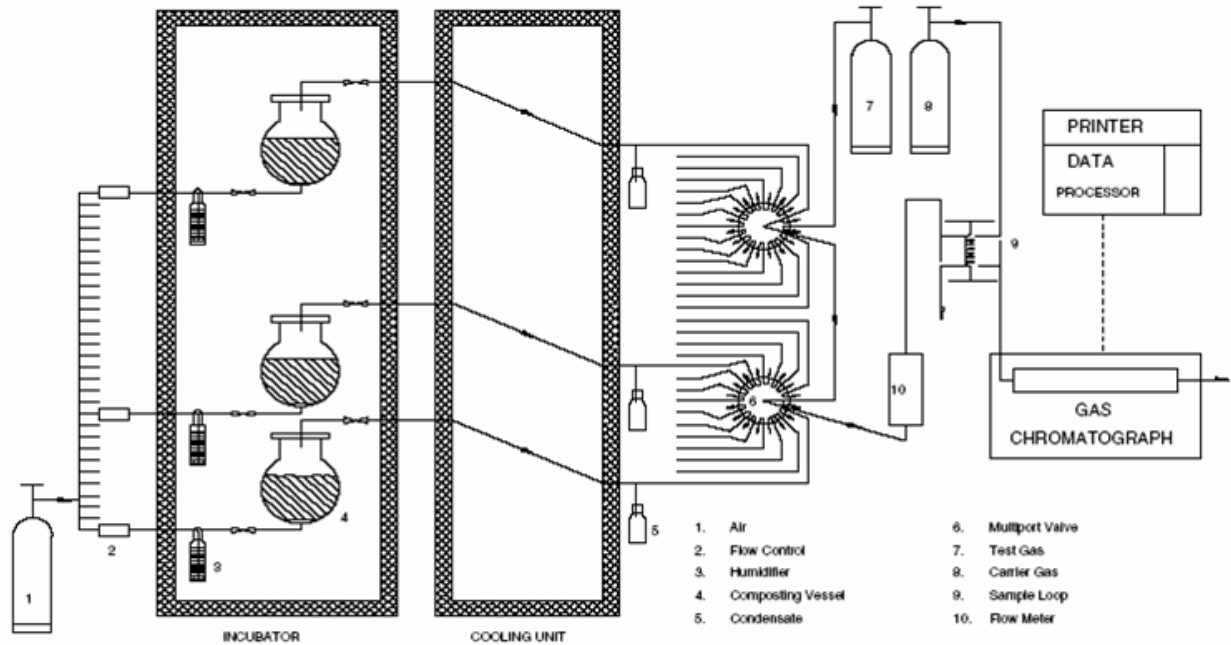

Figure 4-1. Set up for plastic biodegradation assessment in compost - ASTM D5538

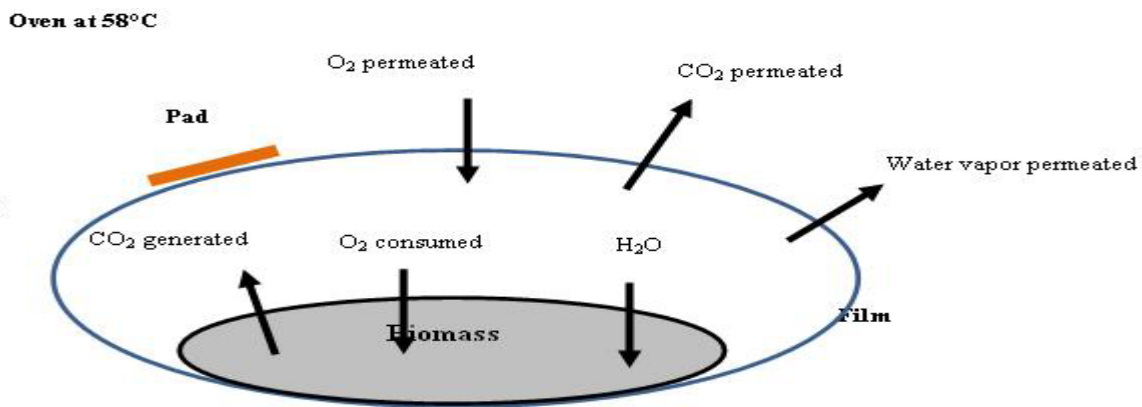
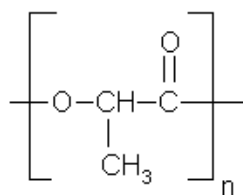

Figure 4-2. Interactions in flexible bags



Figure 4-3. Pictures of flexible bags with biomass biodegrading



C: 36n g/mol
 O: 32n g/mol
 H: 4n g/mol
 PLA: 72n g/mol
 C/PLA: 0.5

Figure 4-4. Chemical formula of PLA

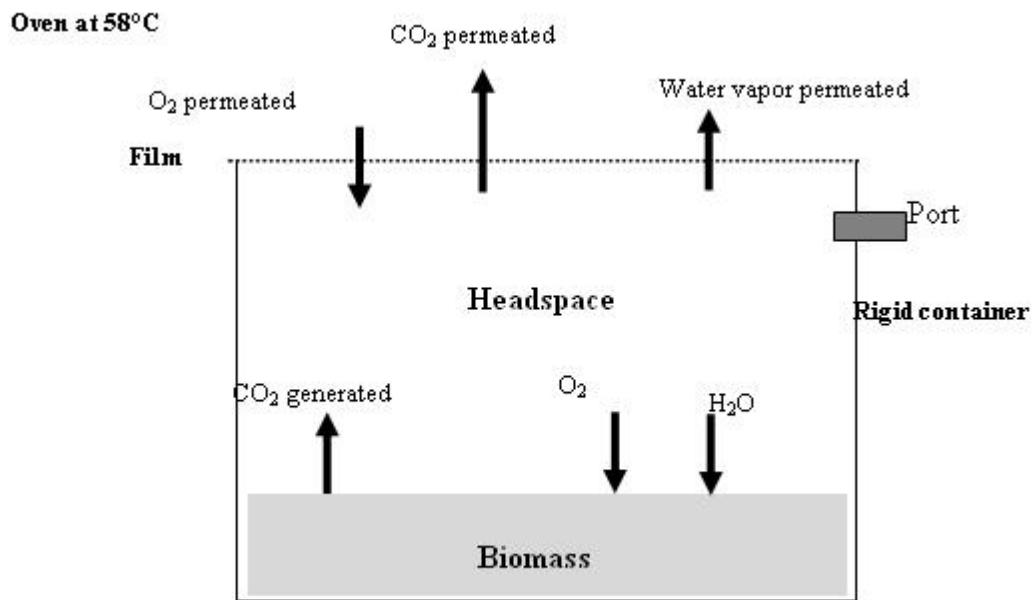

Figure 4-5. Interactions in rigid container with plastic film lid



Figure 4-6. Picture of rigid container with plastic film lid

Oven at 58°C

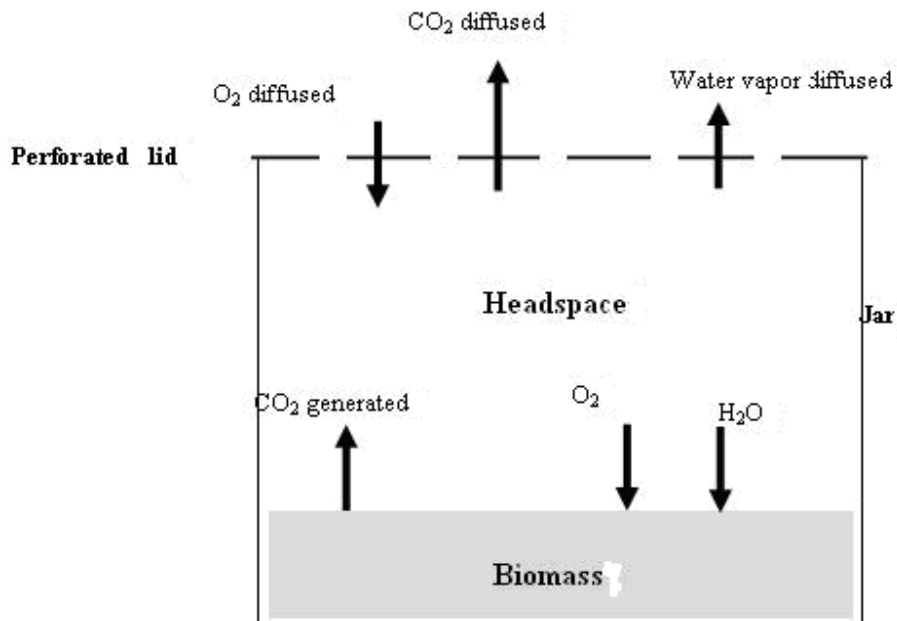

Figure 4-7. Interaction in perforated jar



Figure 4-8. Picture of jar filled with biomass and perforated lid



Figure 4-9. Picture of compost plus PLA after 40 days, in and out of the bag

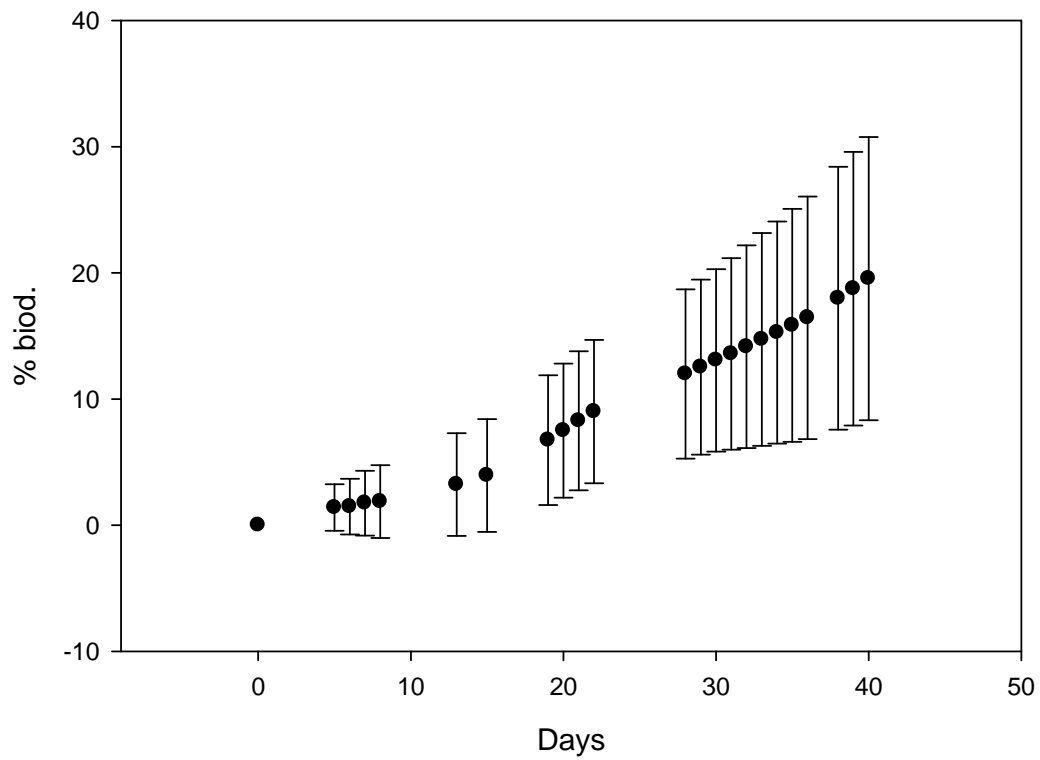

Figure 4-10. Biodegradation of PLA using the method of flexible bags

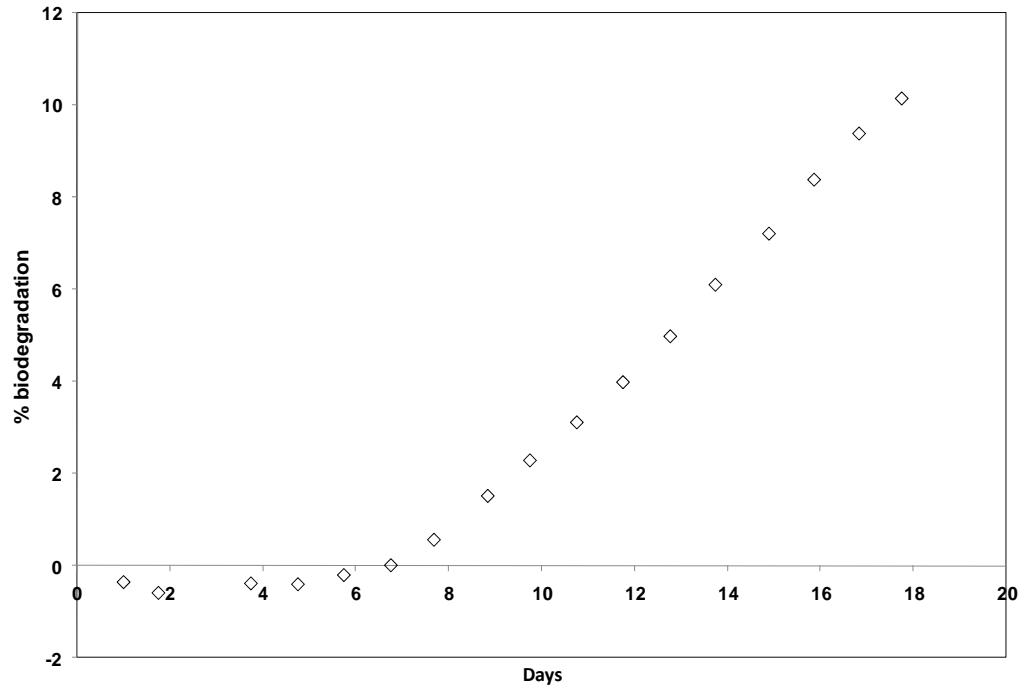

Figure 4-11. Biodegradation of PLA using the method of rigid containers with plastic film lids

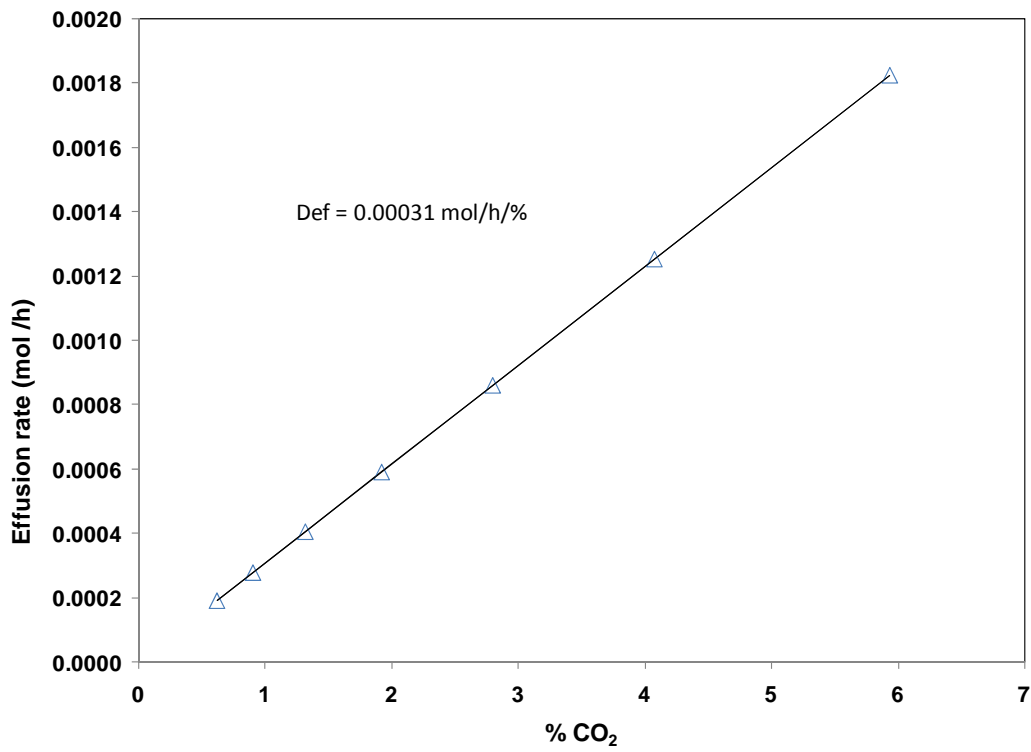

Figure 4-12. Overall effective coefficient of diffusion for CO₂ through 5 holes

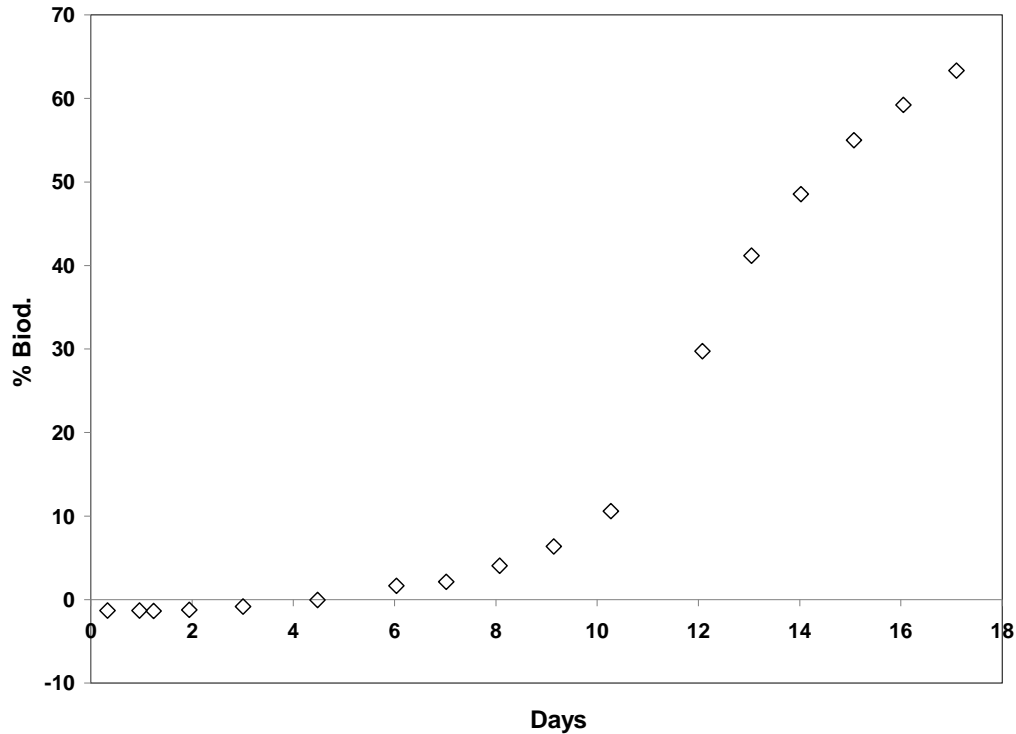

Figure 4-13. Biodegradation of PLA using the method of perforated jars

Table 4-1. Biodegradation of PLA by method of flexible bags

(1) Time, t	(2) [CO ₂]	(3) η CO ₂ permeated	(4) η CO ₂ permeated accumulated	(5) η CO ₂ in headspace
	Determined in headspace analyzer	Use Eq.4-3	(3) _{t=i} + (4) _{t=i-1}	Use eq.4-4

Table 4-1. Continued

(6) η CO ₂ total produced	(7) η CO ₂ total produced by control	(8) η CO ₂ total produced by PLA	(9) Grams of carbon in CO ₂ from PLA	(10) % biodegradation
(4) + (5)	Follow (1) to (6) for bags with only compost	(6) - (7)	12 * (8)	(9)*100 /0.5*WPLA

Table 4-2. Biodegradation of PLA by the method of perforated jars

(1) Time, t	(2) [CO ₂]	(3) η CO ₂ diffused	(4) η CO ₂ permeated accumulated	(5) η CO ₂ in headspace
	Determined though headspace analyzer	Use Eq.4-6	(3) _{t=i} + (4) _{t=i-1}	Use eq.4-7

Table 4-2. Continued

(6) η CO ₂ total produced	(7) η CO ₂ total produced by control	(8) η CO ₂ total produced by PLA	(9) Grams of carbon in CO ₂ from PLA	(10) % biodegradation
(4) + (5)	Follow (1) to (6) for bags with only compost	(6) – (7)	12 * (8)	(9)*100 /0.5*W _{PLA}

CHAPTER 5 BIODEGRADATION OF TREATED PLA UNDER ANAEROBIC CONDITIONS

Introduction

Although the goal of post-consumer use of PLA is to return to the environment during composting, this is not currently happening. Separating PLA from waste and acceptance of PLA in composting plants are proving problematic. Instead, PLA waste is being sent to landfills, where anaerobic conditions prevail and it appears that PLA does not biodegrade significantly [9].

Little is known about the fate of PLA in landfills. Therefore, an objective of this study was to evaluate PLA degradation under anaerobic conditions. Under anaerobic conditions, organic matter usually degrades in four stages: (a) hydrolysis, (b) acidogenesis, (c) acetogenesis, and (c) methanogenesis [44, 45]. During hydrolysis, molecules split and become smaller and soluble resulting in conversion of carbohydrates, fats and proteins, into sugars, fatty acids and amino acids. This chemical reaction requires water and is aided by temperature and enzymes. Later, during acidogenesis, simpler compounds undergo fermentation carried out by acidogenic bacteria, and produce volatile fatty acids, hydrogen and carbon dioxide. Later, during acetogenesis, acetic acid, hydrogen and carbon dioxide are produced. During methanogenesis, the final products of the anaerobic digestion are obtained. These are methane and carbon dioxide.

For this work, it was postulated that untreated PLA biodegrades at a very slow rate because of its large molecular weight, making the necessary first step of hydrolysis difficult. However, pretreatments with steam or irradiation may assist with and/or substitute for hydrolysis and therefore allow PLA to be converted. It is supposed that main anaerobic reactions for converting PLA to biogas follow the sequence given in Figure 5-1. It is suspected that the amount of each intermediate product depends on the microbial strains and temperatures of incubation.

Experiments performed include weight loss of irradiated PLA (gamma and e-beam) and biochemical methane potential (BMP) of steam-treated PLA (120°C x 0h, 3h), both under mesophilic and thermophilic conditions. Also, an experiment of untreated PLA in DI water in absence of oxygen was conducted to assess thermal hydrolytic degradation by itself.

Materials and Methods

Weight loss of PLA in Water under Anoxic Conditions

Rectangular sheets of PLA (1cm x 4cm x 0.2mm) were placed in glass bottles (cap 280ml) containing 100ml of DI water. Jars were flushed with gas N₂/CO₂ (70/30) for 30 minutes to remove oxygen and then immediately sealed. Some jars were stored for 180 days at 37°C in an Isotemp™ Low Temperature Incubator (Fisher Scientific, Inc., Philadelphia, PA). Others, at 58°C in a Lab-Line® L-C Incubator (Lab-Line Instruments, Inc., Melrose Park, IL) for the same time. Dried and cleaned PLA samples were weighted at the beginning and the end of the experiment to evaluate their thermal degradation in absence of oxygen at 37°C and 58°C.

Weight Loss of Irradiated PLA in Anaerobic Biological Media

Clear glass bottles (cap. 280ml) were filled with small pieces of irradiated PLA (~5mm x 7mm x 0.2mm), 90 ml of nutrient formula (Appendix F) and 10 ml of inoculum. Irradiated PLA pieces were subjected to gamma rays from cesium 137 source (0, 72 and 172 kGy) and electron beam (0, 72, 144 and 216 kGy). Controls consisted of media and inoculum but without PLA. Inoculum was provided by the Bioprocess Lab of the Agricultural & Biological Engineering Department at University of Florida. Inoculum was cultures of naturally occurring microorganisms, capable of growing under mesophilic (25-45°C) or thermophilic (>45°C) conditions [19]. After bottles were filled, they were flushed with gas N₂/CO₂ (70/30) for 30 minutes to remove oxygen. Bottles were sealed and stored for 180 days at 37°C in a Isotemp™ Low Temperature Incubator (Fisher Scientific, Inc., Philadelphia, PA), and at 58°C in a Lab-

Line[®] L-C Incubator (Lab-Line Instruments, Inc., Melrose Park, IL). These temperatures provided favorable conditions for biological activity of mesophilic and thermophilic microorganisms, respectively.

Weight of dried and cleaned PLA samples was determined at the beginning and end of the experiment to evaluate effects of irradiation in anaerobic biodegradation. Bottles that were set up looked like in Figure 5-2.

Biochemical Methane Potential (BMP) of Steam-Treated PLA in Anaerobic Biological Media

The biochemical methane potential assay is a procedure developed to determine the methane yield of an organic material during its anaerobic decomposition by a mixed microbial flora in a defined medium. This assay provides a simple means to monitor relative biodegradability of substrates.

Clear glass serum-bottles (cap. 280ml) were filled with 1 gram of ground solid steam-treated PLA, 100 ml of nutrient formula (Appendix F) and 10 ml of naturally occurring inoculum (mesophilic or thermophilic) supplied by the Bioprocessing Lab of the Agricultural & Biological Engineering Department at University of Florida. Grinding of PLA was performed using an Urschel 3600 grinder (Urschel Laboratories, Inc., Valparaiso, IN) with a 3mm screen. Ground PLA was a sample of the solid residue after steam treatment (120°C x 0h and 3h). Drip was discarded. Controls consisted of glass bottles with the nutrient formula and inoculum, but without PLA. After filling, bottles were flushed with gas N₂/CO₂ (70/30) for 30 minutes to remove oxygen. Later, bottles were sealed and stored for 28 days at 37°C in a Isotemp[™] Low Temperature Incubator (Fisher Scientific, Inc., Philadelphia, PA), and at 58°C in a Lab-Line[®] L-C Incubator (Lab-Line Instruments, Inc., Melrose Park, IL). These temperatures provided favorable conditions for biological activity of mesophilic and thermophilic microorganisms.

Biochemical methane potential bottles and steam-treated ground PLA looked as in Figure 5-2 and Figure 5-3.

Weekly, gas production and composition were determined using a Gas Partitioner Chromatograph model 1200 (Fisher Scientific, Inc., Philadelphia, PA) adapted with a thermal conductivity detector. Biochemical methane potential (BMP) of PLA was expressed as yield of methane per gram of PLA sample loaded into BMP bottles, and was determined in accordance to ASTM E1196 [46]. Data collected were inserted into columns (1), (2) and (3) of Table 5-1. The volume of methane removed was calculated and expressed at standard conditions of temperature and pressure (0°C, 1atm) after removing the vapor pressure effect at respective temperatures. Plots of columns (1) and (11) depict the yield of methane per gram of PLA (untreated and steam-treated).

Results and Discussion

Weight Loss of PLA in Water Under Anoxic Conditions

Table 5-2 shows the weight loss of untreated PLA in oxygen-free water after 180 days. Results demonstrate that degradation occurs at 58°C but not at 37°C. Evaluated samples were not subjected to any kind of chemical reaction or biological activity, so mechanism for degradation in absence of oxygen was solely thermal hydrolysis.

Weight Loss of Irradiated PLA in Anaerobic Biological Media

Under thermophilic conditions (58°C), all samples were disintegrated and lost in the media. It can be said that weight loss was almost 100%. In some cases, gelatinous PLA pieces were found which easily dissolved in the media when subjected to agitation. At this temperature, the mechanism of PLA degradation is a combination of thermal hydrolysis and biological activity that would produce methane. These data were not useful for determining effects of

irradiation dose, irradiation source and biological activity on PLA, so data collected from mesophilic conditions were used for this purpose.

Figure 5-4 shows weight loss of irradiated PLA (gamma and e-beam) under mesophilic conditions (37°C) after 180 days. PLA samples appeared to be much more vulnerable to anaerobic biological media when pre-irradiated with gamma source rather than e-beam. For instance, γ -irradiated PLA at 172 kGy lost 45% of weight whereas e-beam irradiated PLA at 216 kGy lost only 3% under same anaerobic biological conditions after 180 days. This difference likely occurred because gamma irradiated PLA samples had lower molecular weights and weaker structures than those irradiated with electron beam (see Figure 2-5 and Figure 2-8), so they were more sensitive to biological activity.

At 37°C, un-irradiated PLA samples presented negligible weight loss under anaerobic conditions. But, as seen in Figure 5-4, irradiation dose played an important and accelerated role (more when treated with gamma rays) in PLA anaerobic biodegradation. That means that at higher irradiation doses, the weight loss effect was much more pronounced than at lower irradiation doses. At this temperature, the main mechanism for weight loss is biological activity performed by mesophilic microorganisms, since thermal hydrolysis has been shown not to occur.

Biochemical Methane Potential (BMP) of Steam-Treated PLA in Anaerobic Biological Media

Figure 5-5 shows methane production by untreated and steam-treated PLA under anaerobic conditions. Untreated PLA subjected to mesophilic conditions did not degrade. However, samples subjected to thermophilic conditions did degrade. Therefore, temperature of incubation is a key factor for anaerobic biodegradation of PLA. Results obtained for mesophilic conditions match data from literature [4, 47]. Untreated PLA subjected to thermophilic conditions produced 187 ccCH₄/g in 56 days. No data has been found in literature regarding PLA degradation under

thermophilic conditions. In this work, it was demonstrated that PLA evolves methane after 21 days in anaerobic media at 58°C. This result was anticipated from prior work with compost when conditions unintentionally became anaerobic, but yet CO₂ production at 58°C was observed. For these samples, hydrolysis and acidification took place mostly during the first 3 weeks, followed by methanogenesis.

Regardless of temperature of incubation, steam-treated PLA samples (120°C x 3h) produced more methane than untreated PLA. Under mesophilic and thermophilic conditions, yields of 90 and 225 ccCH₄/g were obtained for treated PLA (improving “negligible” and 187 ccCH₄/g from untreated). At 58°C, steam-treated PLA began producing CH₄ at the beginning of incubation, whereas for untreated PLA, CH₄ was not observed until after the third week. This suggests that steam treatment provides a head start effect. At 37°C, it was shown that PLA can biodegrade in anaerobic media only if material is pretreated.

Conclusions

Untreated PLA does not degrade under mesophilic conditions, but does under thermophilic conditions. Methane yield of 187 ccCH₄/g after 56 days at 58°C was observed. Mechanism for degradation is hydrolysis and acidification during the first 3 weeks, followed by methanogenesis.

Treated PLA, using steam or irradiation, does biodegrade under anaerobic conditions, either in mesophilic or thermophilic circumstances. This means that it will ultimately evolve as carbon dioxide and methane at either temperature range. For steam-treated PLA (120°C x 3h), methane production was 90 and 225 ccCH₄/g after 56 days of incubation at 37°C and 58°C. Gamma irradiated PLA samples biodegraded faster than e-beam irradiated PLA, which is related to oxygen protection afforded by high dose rates associated with e-beam treatments. Gamma treatment was more effective in reducing molecular weight, which contributed to the head start effect of γ -radiation. Gamma irradiated PLA with absorbed dose of 172 kGy lost 45% of its

weight at 37°C after 180 days. This reduction in weight is mainly caused by biological conversion of PLA to aqueous soluble oligomers, lactic acid, acetic acid, and probably evolution to carbon dioxide and methane. Also, it was noticed that regardless of irradiation source (i.e gamma irradiation/Ce 137 or e-beam), higher absorbed doses provided higher rates of biodegradation.

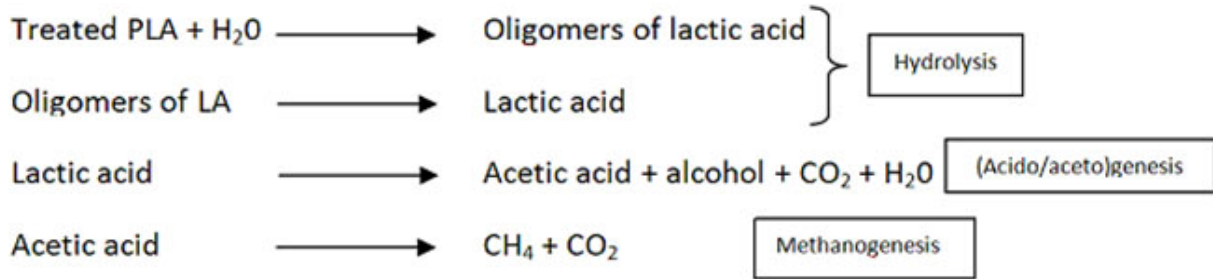

Figure 5-1. Supposed anaerobic reactions for PLA anaerobic biodegradation



Figure 5-2. BMP bottle with anaerobic media



Figure 5-3. Steam-treated ground PLA

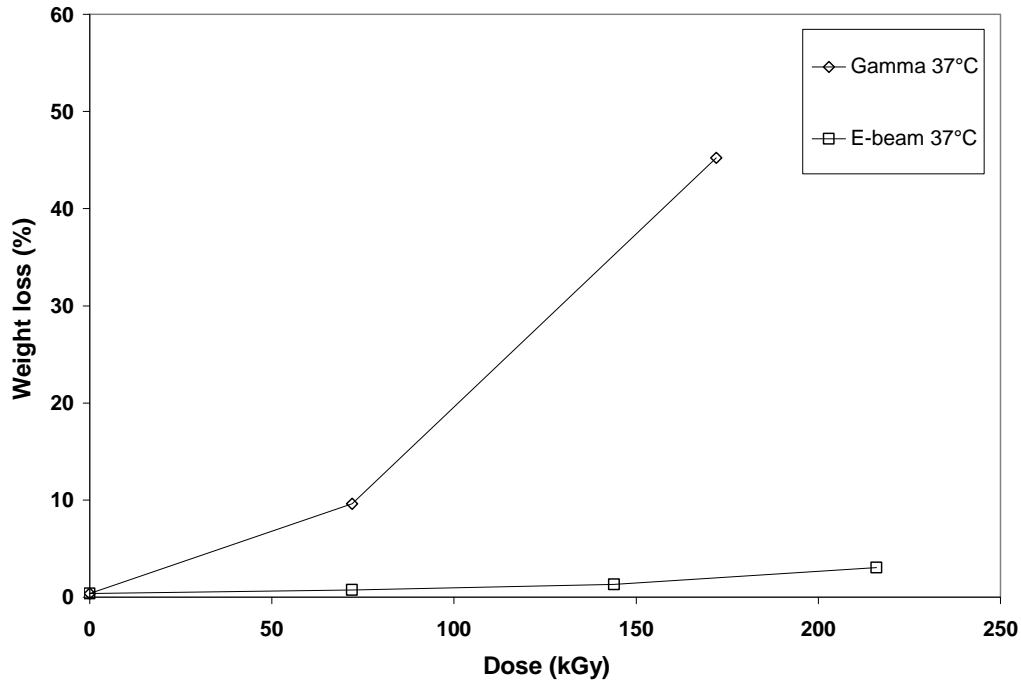

Figure 5-4. Weight loss of irradiated PLA

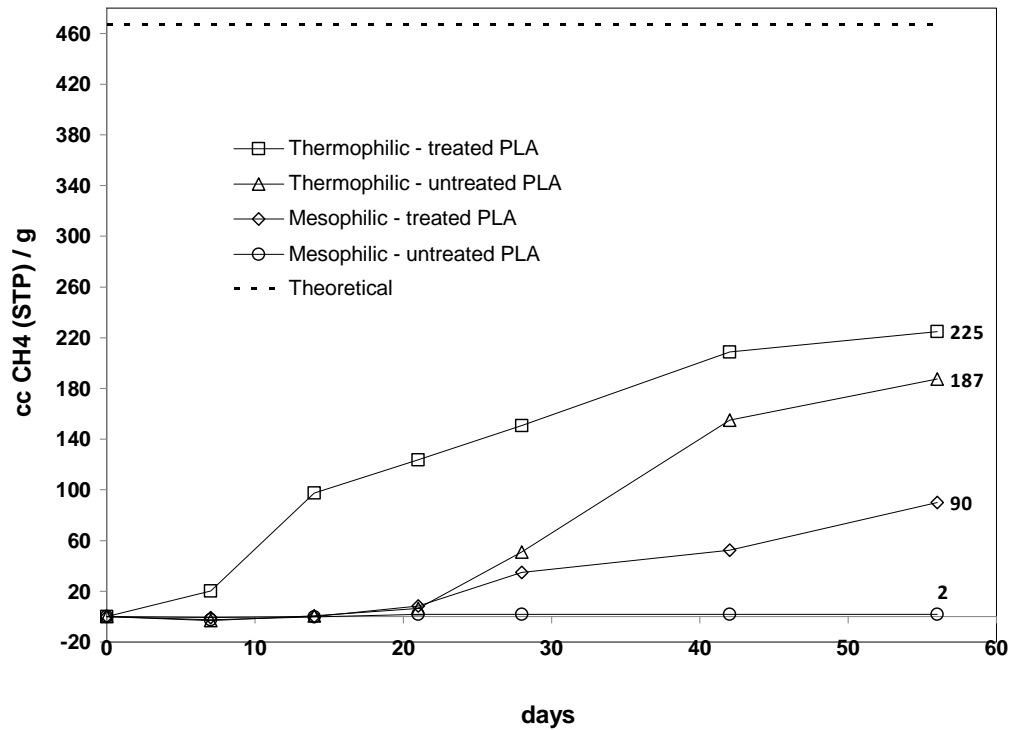

Figure 5-5. Conversion of steam-treated PLA (120°C x 3h) to CH₄ under anaerobic conditions

Table 5-1. Production of methane in steam-treated PLA

(1) Time	(2) cc gas removed	(3) % CH ₄	(4) cc CH ₄ removed	(5) cc cumulative CH ₄ removed	(6) cc CH ₄ in headspace	(7) cc CH ₄ total
	Syringe displacement	GC	(2)*(3)/100	(4)t=i + (5)t=i-1	V _{hs} *(3)/100 ^(a)	(5) + (6)

Table 5-1. Continued

(8) cc CH ₄ total @ STP	(9) cc CH ₄ total produced by control	(10) cc CH ₄ total produced by PLA	(11) CH ₄ yield (cc/ g VS)
(7)*(273.15/T)*F ^(b)	Follow steps (1) to (8) for bottles with control	(8) – (9)	(10)/W _{PLA}

(a) Estimated in each gas sample analysis

(b) Correction due to pressure vapor: $F = (760 - p_{vap}) / 760$. $p_{vap}(58^\circ\text{C}) = 136\text{mm Hg}$. $p_{vap}(37^\circ\text{C}) = 47\text{mm Hg}$ [48]

Table 5-2. Weight loss of untreated PLA in water under anoxic conditions

Temperature (°C)	Weight loss (%)
37	0.19±0.2
58	98.96±1.5

CHAPTER 6 BIODEGRADATION OF STEAM-TREATED PLA UNDER COMPOSTING CONDITIONS

Introduction

Reactions that occur during PLA biodegradation in a composting process occur in three stages summarized in Figure 6-1. First, PLA hydrolyzes producing lower molecular weight PLA. This stage requires water and energy, but the presence of microorganisms is not essential. Then, low molecular weight PLA undergoes production of oligomers and lactic acid. During this second stage, hydrolysis still occurs but biological activity takes place more intensively, and is aided by appropriate temperature, and moisture and oxygen levels. The third stage is carried out only by biological activity and produces carbon dioxide and water [36]. Depending on the pH and the microbial cultures, radicals could also be produced and combined with the biomass to integrate humic acids in the compost. Also, a small part of the carbon dioxide fraction transforms to carbonic acid and bicarbonates transformations due to high moisture levels in the media.

The main objective of this research is to evaluate the effectiveness of different processes as potential pre-composting treatments for PLA waste, and to determine whether they will allow complete degradation within the time frame of normal organic compost. In Chapter 2, it was demonstrated that exposure of PLA to steam is the most effective treatment to reduce molecular weight and affect structural integrity.

In this chapter, steam-treated PLA samples were subjected to composting conditions to evaluate their biodegradation, via the method of perforated jars described previously (Chapter 4). Additional experiments to determine the kinetics of biodegradation were performed.

Results of this work validate the hypothesis of this study, which states that pre-composting treatments able to reduce PLA molecular weight will be favorable in subsequent composting processes by reducing overall biodegradation time. An important question is whether

pretreatments provide a “head start” in further composting, and/or contribute to “accelerate” conversion of PLA.

The “head start” effect is shown in Figure 6-2. A typical curve representing PLA biodegradation in the composting process can be described through 3 phases: (a) a lag period, (b) an accelerated biodegradation phase, and (c) a decelerated biodegradation phase until reaching a plateau. A “head start” effect would shift the curve in time, so that the lag period would be shortened or eliminated, but the trend of the curve would be maintained. So, a “head start” effect would be expected to displace the entire curve to the left. As a consequence of this “head start” effect, overall biodegradation time will be reduced.

The “acceleration” effect is illustrated in Figure 6-3. Here, the biodegradation rate must be carefully analyzed once the lag period is complete. The slope of the curve (in the earlier phase) represents initial biodegradation rate, and is an indicator of how rapidly carbon dioxide is evolving. In Figure 6-3, the dashed curve depicts biodegradation evolution of PLA exhibiting the “acceleration” effect, represented by a steeper slope.

Material and Methods

Steam-Treated PLA Biodegradation in Compost

Previously (Chapter 4), the method of perforated jars was described. In this section, this method was used to determine the kinetics of steam-treated PLA biodegradation in compost. Samples of PLA were ground using an Urschel 3600 grinder (Urschel Laboratories, Inc., Valparaiso, IN) with a 3mm screen, and then subjected to steam at 120°C for 0, 1, 2 and 3 hours.

Mason jars of 936cc capacity provided with 5 holes (x 1/16”) in the lids were filled with 100g of 6-month mature compost (Appendix A) and 10g of ground PLA samples. Sealed jars were stored at 58°C for 31 days in a Lab-Line[®] L-C Incubator (Lab-Line Instruments, Inc., Melrose Park, IL). Beside routine practices such as agitation and moisturizing, concentration of

gases in the headspace was determined daily using a gas analyzer Pac Check[®] 650 (Mocon, Inc., Minneapolis, MN). Data collected was processed according to the methodology described earlier in chapter 4 in order to create curves of PLA biodegradation over time.

Kinetics of Steam-Treated PLA Biodegradation in Compost

Data of biodegradation were plotted and adjusted to the logistic model with three parameters shown in Equation 6-1. Parameters were estimated using nonlinear regression performed with SigmaPlot v.10. Ideally, parameter a should be 100. Parameter b is associated with the lag period, and the parameter x_o represents the time at which half of the biodegradation would be completed. For untreated PLA, large values of parameters b and x_o were expected, whereas for treated PLA smaller values were expected.

$$\%biod.=\frac{a}{1+(t/x_o)^{-b}} \quad (6-1)$$

Weight Loss of Steam-Treated PLA in Compost and Comparison with other Common Feedstock

Flat sheet samples with rectangular or circular shapes, with similar surface area (~12.5 cm²) were prepared from steam-treated PLA wrapped in nylon screen envelopes, wood and virgin corrugated paperboard. These samples were dried, weighed and immersed in water for 10 minutes. Wet samples were placed individually into perforated mason jars (cap.936cc) containing 200g of 6-month mature compost (Appendix A). Controls were jars filled with 200g compost. Closed jars were stored in a Lab-Line[®] L-C Incubator (Lab-Line Instruments, Inc., Melrose Park, IL) for 14 days at 58°C.

Periodically, jars were gently shaken to ensure uniform contact of samples with compost, and water was injected to maintain proper moisture content of the biomass. Samples were covered by the compost at all times to promote biological activity. At the end of the experiment,

samples were removed from the jars, carefully washed, dried and weighted. Weight loss of each individual sample was determined using Equation 2-1.

Results and Discussion

Steam-Treated PLA Biodegradation in Compost

Figure 6-4 shows evolution of steam-treated PLA (120°C x 0, 1, 2 and 3 hours) biodegradation under composting conditions. On average, rates of biodegradation increased as steam treatment became more severe. These results validate the general hypothesis of this study, which states that a pre-composting treatment capable of reducing PLA molecular weight would increase biodegradation rate in subsequent composting process. This figure also confirms the “head start” and “acceleration” effects, which were postulated as means by which PLA conversion would be enhanced. As steam treatment increased, “head start” and “acceleration” effects also increased.

During the experiment, oxygen concentration in the headspace was monitored and found to be above 17.8% at all times. Agitation permitted good aeration and mixing, but it needed to be performed carefully in order to minimize clumping of the particles. Unfortunately, clumping occurred in the jar containing PLA treated with steam for 3 hours at 120°C during the last days of the experiment. Clumping appeared to slow biodegradation during those last days, probably due to a lesser area exposed to the environment.

According to standards, “biodegradability” requires 60% conversion. In this regard, samples treated at 120°C for 3, 2 and 1 hours reached biodegradability after 14, 16 and 19 days. Untreated samples did not achieve biodegradability even after 31 days. Observations of biomass through glass jars confirmed previous results. Steam-treated PLA at 120°C for 3 hours was no longer seen in biomass after 14 days of composting. Even when total biodegradation was not yet achieved, PLA had apparently disappeared, and it could be said that breakdown was complete.

However, continued production of CO₂ attributed to PLA material suggests the presence of PLA, probably as oligomers, and lactic acid.

It was also observed that more severe treatments (i.e. 120°C x 3h) did not create a lag period for adaptation or conditioning. In these samples, the rate of biodegradation was very high at the beginning of the experiment and then decreased over time. In contrast, PLA samples less severely treated (i.e. 120°C x 1h) showed a sigmoidal behavior, represented by a lag period, accelerating and decelerating stage.

It is said that a material must fulfill three conditions to be compostable [49]: (a) it must biodegrade quickly, (b) it must not alter the quality of the compost, and (c) it must disintegrate. Samples of steam-treated PLA fulfilled these conditions. The 31-days biomass, consisting of biodegraded treated PLA in compost, had similar appearance, texture and odor as compost without PLA. The pH of the final biomass (~6.6-6.8) did not change (Table 6-1). Pictures of the compost with and without treated PLA are shown in Figure 6-5. There was no apparent difference between the two compost samples.

Kinetics of Steam-Treated PLA Biodegradation in Compost

Nonlinear regression to fit experimental data to the logistic model was obtained using SigmaPlot v.10. Outputs are shown in Table 6-2.

Parameters of the model are related with the pattern and magnitudes of the biodegradation curves. The parameter a is the plateau, which is the maximum value of biodegradation that can be achieved. In all cases the value of a is close to 100 which is the theoretical plateau. The parameter b is associated with the lag period, so smaller values indicate shorter times, and larger values of b indicate longer times to start biodegrading at a high rate. This matches experimental results, where more severe pretreatments resulted in lower values of b (for instance, steam-treated PLA at 120°C x 3h got the shortest value of b , and untreated PLA the highest). Finally,

the parameter x_o is the time at which half of the biodegradation will be completed. Thus, larger values of x_o indicate longer total times for biodegradation. This explains why untreated PLA biodegradation curve had a much higher values of this parameter. The goodness of fit was excellent in all curves as represented by r-square values very close to unity. Figure 6-6 shows experimental data and predicted values from the model.

Weight Loss of Steam-Treated PLA in Compost and Comparison with other Common Feedstock

Figure 6-7 shows results of weight loss of steam-treated PLA (120°C x 3h, 4h), wood and virgin corrugated paperboard in 6-month mature compost. Treated PLA samples were the only ones that broke apart inside the compost. Screened envelopes were designed to retain broken parts for further weighting. After 14 days, steam-treated PLA achieved weight losses of 94.9% (120°C x 4h) and 86.4% (120°C x 3h), whereas wood and corrugated board achieved values of 0.9% and 39.2%, respectively. These results demonstrate that PLA subjected to steam (120°C x 3 and 4 h) breaks down much faster than wood and virgin corrugated paperboard, which are usually accepted in composting facilities. Figures 6-8, 6-9 and 6-10 show pictures of these samples, and it was observed that steam-treated PLA was most greatly affected.

Conclusion

It has been demonstrated that steam-treated PLA is affected very significantly in compost, breaking down even faster than common organic feedstock universally accepted in composting facilities such as wood and virgin corrugated paperboard. Polylactic acid treated with steam at 120°C for 3, 2 and 1 hours, achieved degradability (60% of conversion to CO₂) after 14, 16 and 19 days, whereas untreated PLA did not achieve biodegradability even after 31 days. Degradability was evidenced by complete PLA disappearance. Additionally, resulting compost did not appear to be affected by a loading of about 10% by weight PLA in compost.

Characteristics of the final compost when steam-treated PLA was initially present were similar than those of the compost by itself. The three requirements for compostability are fast breakdown, total disintegration and no alteration; thus, steam-treated PLA should be considered to be compostable.

Biodegradation kinetics of PLA fit very well using the proposed logistic model with three parameters, and provides valuable information for understanding biodegradation behavior. Determined parameters confirmed that pre-composting treatments that reduced PLA molecular weight provided “head start” and “acceleration” effects during subsequent composting process. Parameter “b” from the model is associated with the lag period and therefore, with the “head start”. The “acceleration” effect is associated with the derivative of the model after the lag period.

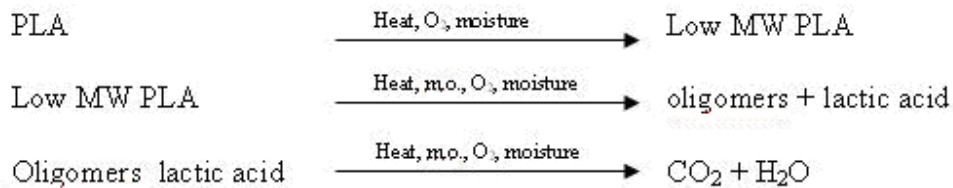

Figure 6-1. Main reactions in PLA biodegradation

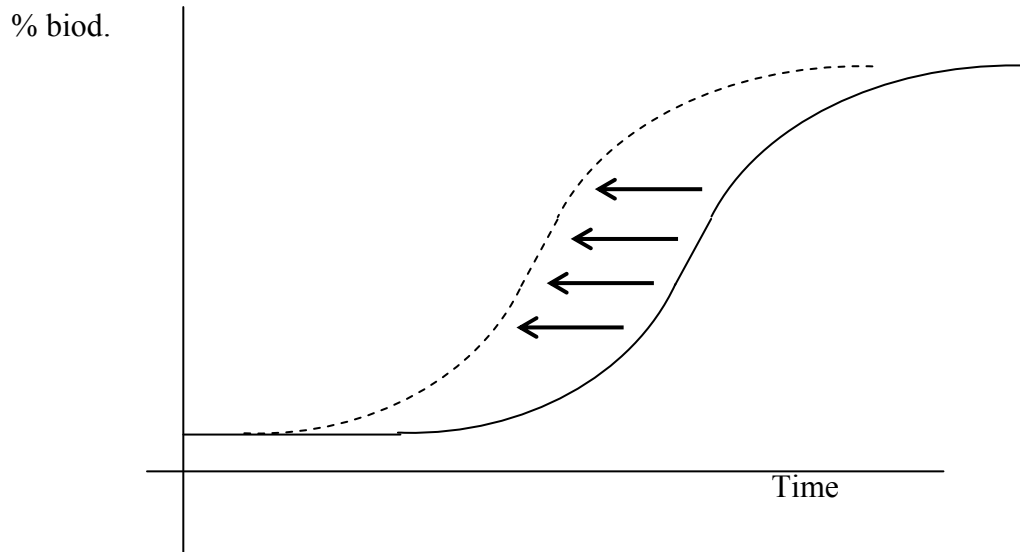

Figure 6-2. "Head start" effect

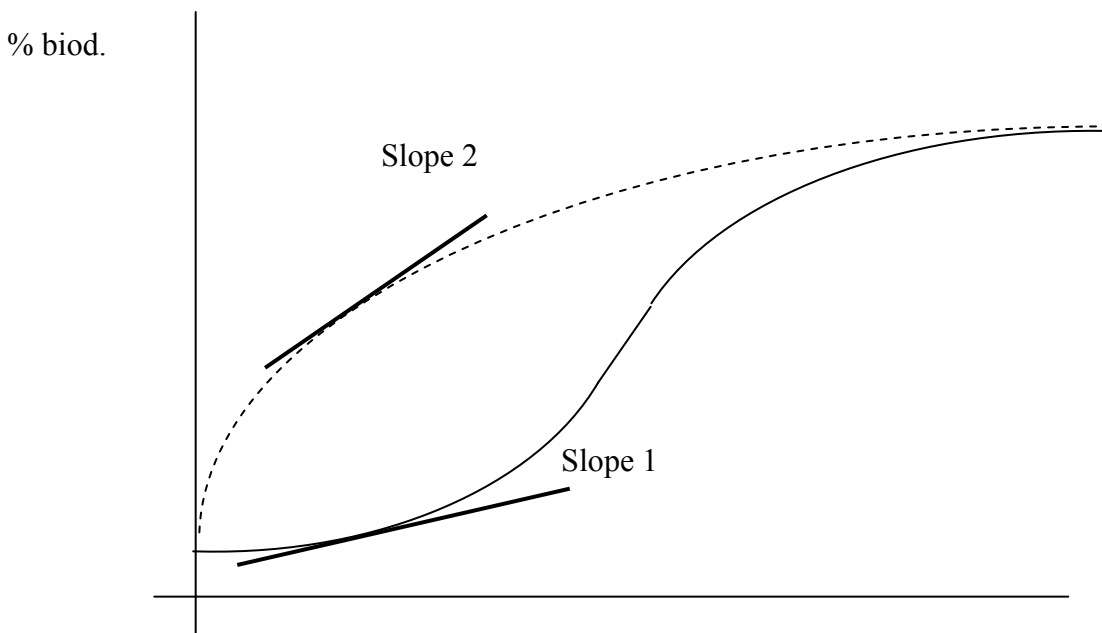

Figure 6-3. "Acceleration" effect

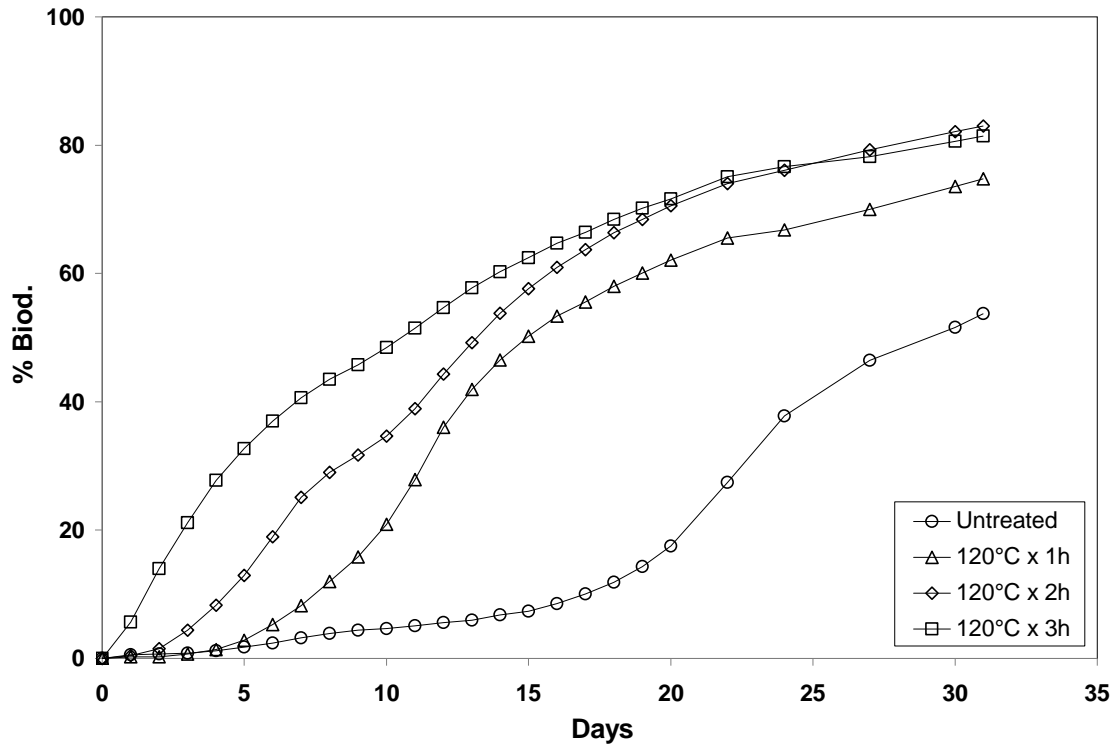

Figure 6-4. Biodegradation of steam-treated PLA over time in compost



Figure 6-5. Biodegraded PLA in compost: (a) compost by itself, (b) compost + PLA (not seen any more)

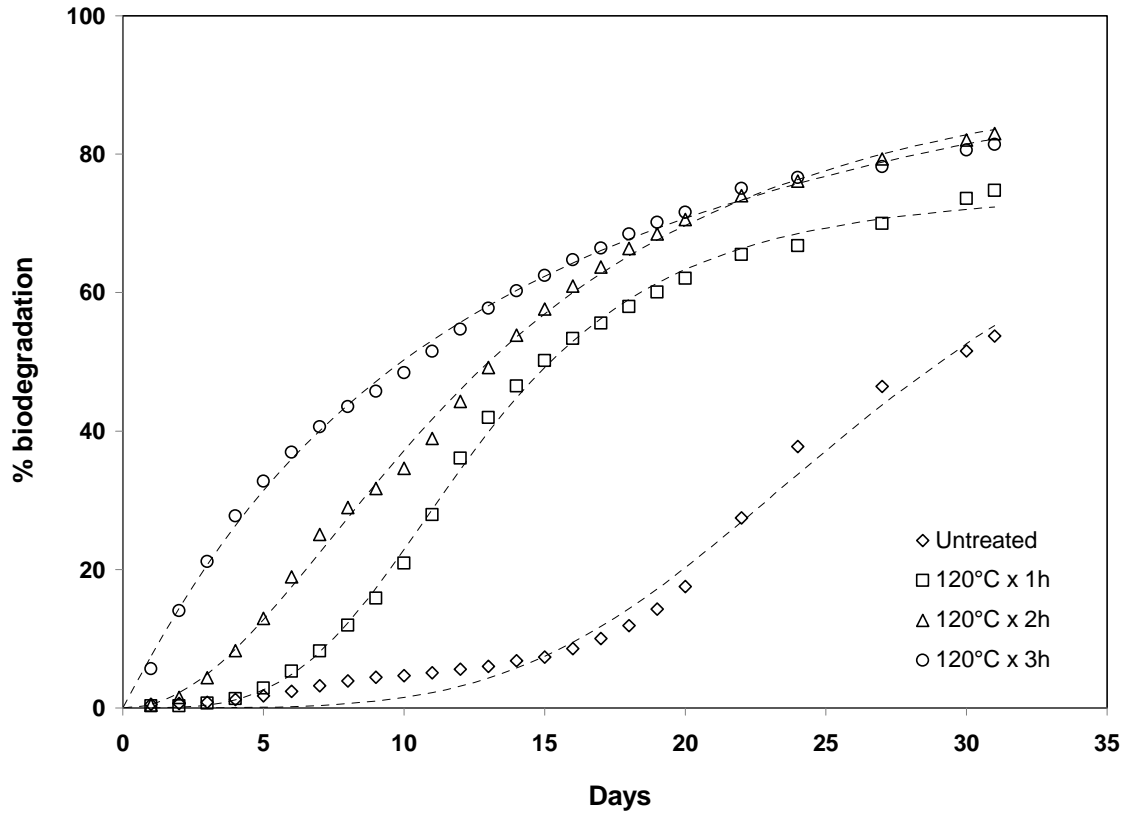

Figure 6-6. Logistic model fit for PLA biodegradation data

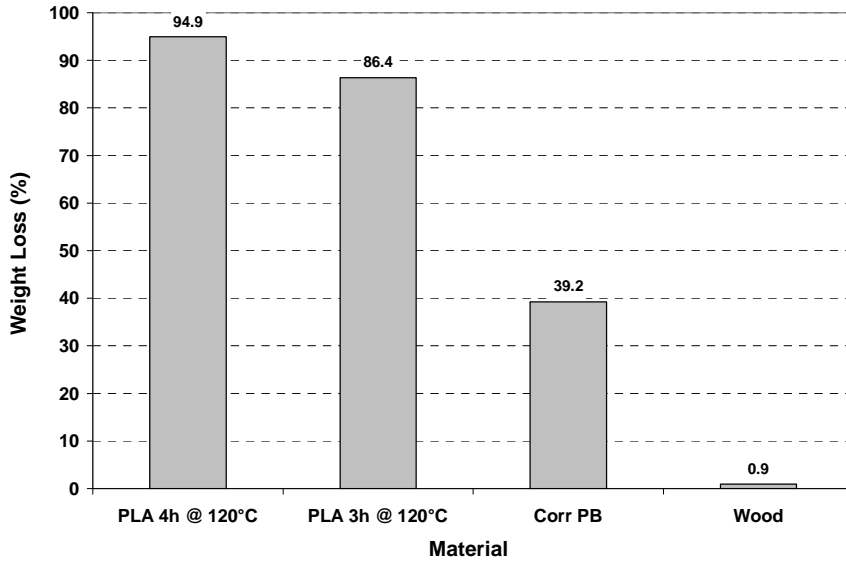

Figure 6-7. Weight loss of steam-treated PLA in compost compared with corrugated board and wood.

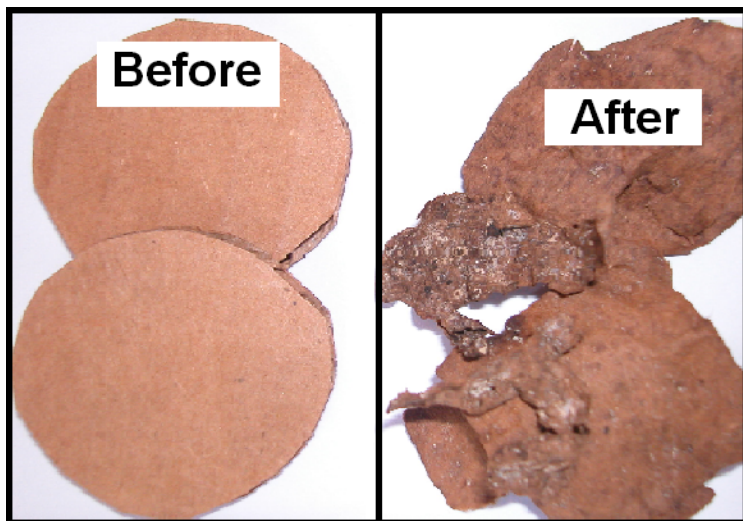

Figure 6-8. Corrugated paperboard subjected to compost for 14 days

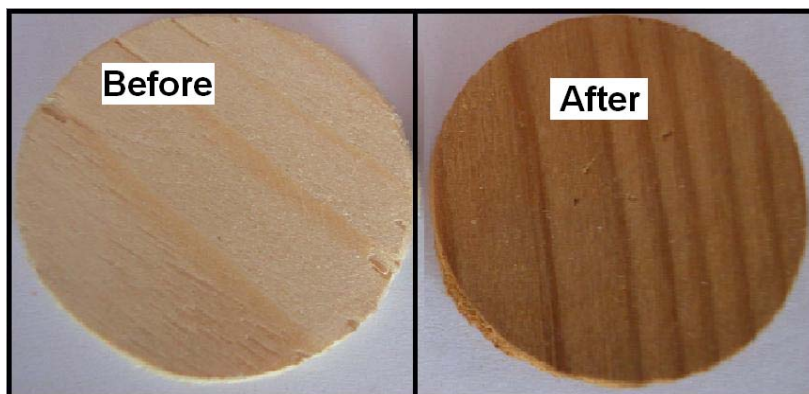

Figure 6-9. Wood subjected to compost for 14 days

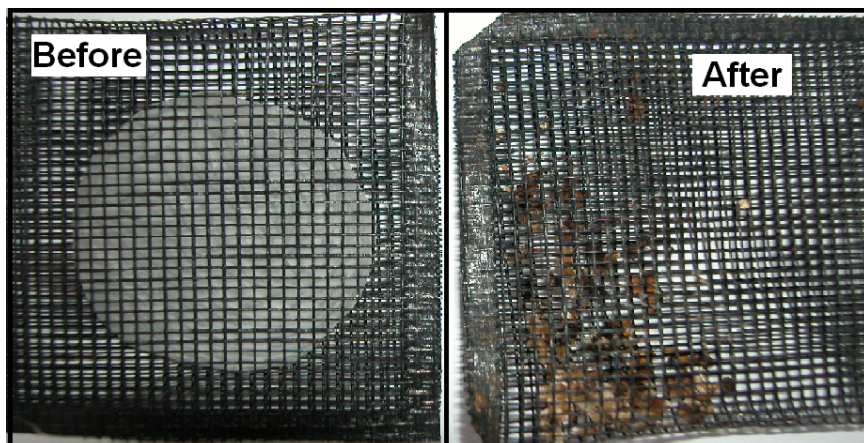

Figure 6-10. Steam treated PLA (120°C x 3h) subjected to compost for 14 days

Table 6-1. pH of biomass (compost + biodegraded PLA)

Sample	pH
Compost	6.7
0h @ 120°C	6.6
1h @ 120°C	6.6
2h @ 120°C	6.6
3h @ 120°C	6.8

Table 6-2. Parameters of the logistic model ($\%biod = a / (1 + (t/x_0)^{-b})$)

	Untreated	1h @ 120°C	2h @ 120°C	3h @ 120°C
<i>a</i>	84.01	75.15	96.91	113.8
<i>b</i>	4.103	3.612	2.04	1.05
<i>x₀</i>	26.45	12.57	12.61	12.49
R-square	0.9819	0.9981	0.9981	0.9981

CHAPTER 7 CONCLUSIONS

Among all the treatments intended to reduce PLA molecular weight, exposure to steam is the most effective, achieving a reduction of 94% when subjected to steam at 120°C for 4 hours. The main mechanism for this event is thermal hydrolysis. Gamma irradiation is also a good treatment for reducing PLA molecular weight, achieving a reduction of 86% when absorbed dose was 172 kGy.

Steam treatment of PLA is a process that hydrolyzes the polymer molecule until complete de-polymerization to lactic acid units, as it was confirmed by FTIR-ATR analysis. At 120°C for 24h, PLA weight loss was 84.7% suggesting significant conversion to lactic acid. It is believed that steam treatments may be suitable not only for making PLA waste more accommodating to commercial composting operations, but also for assisting with separation of PLA from traditional plastic wastes. The model that describes molecular weight reduction in PLA as a consequence of hydrolytic steam treatment follows first order kinetics with activation energy, E_a , of 52.3 KJ/mol.

To evaluate PLA biodegradation in compost, the most reliable and user friendly method designed and developed was the method of perforated jars. This method does not require a complex and expensive gas supply system as the one proposed in the standards (ASTM D5338 and ISO 14855) and is much easier to conduct and adapt.

Under anaerobic conditions, untreated PLA did not biodegrade at mesophilic temperature. Polylactic acid did degrade under thermophilic conditions. Treated PLA, using steam or irradiation, degraded in mesophilic or thermophilic conditions, and at higher rates than untreated PLA. For anaerobic digestion, steam-treatment was more effective than gamma irradiation treatment, and gamma irradiation treatment was more effective than electron-beam irradiation. The best results observed were for the most severe treatment studied, which was steam at 120°C

for 3 hours, followed by anaerobic digestion under thermophilic conditions, where methane yield was 225 ccCH₄/g after 56 days.

Under aerobic conditions it was confirmed that steam-treatment provided “head start” and “acceleration” effects to PLA biodegradation. Ground PLA subjected to steam at 120°C for 3 hours achieved biodegradability (60% of conversion as CO₂) in 14 days, whereas untreated PLA did not achieve this state even after 31 days. It was verified that steam-treated PLA (120°C x 3h) undergoes breakdown even faster than virgin corrugated paperboard and wood, common feedstock universally accepted in composting plants. In addition, at a rate of 10% of compost feedstock, steam-treated PLA does not appear to alter the compost during the time it is breaking down.

Three findings of this work are significant. First, it was found that PLA biodegrades under anaerobic thermophilic conditions. This finding is important because post-consumer PLA material may be used in anaerobic digestion for energy recovery, instead of being treated as waste disposal. Second, a simple and reliable method to determine biodegradation of polymers under composting conditions was developed. This method, named “method of perforated jars,” may be a valuable contribution to biodegradation assessments and may serve as a more convenient and less expensive alternative to current standard methods. Finally, steam-exposure can be also seen as a potential technique for recycling PLA. This is possible since, under steam conditions, PLA hydrolyzes to lactic acid which is soluble in water, and therefore, may be separated from the plastic waste stream and re-polymerized into virgin PLA.

There are big differences between biodegradable, bioerodable and compostable. PLA is slightly biodegradable and bioerodable in composting conditions. However, this is insufficient for commercial composting operations. Steam treatments may help to separate PLA from

municipal solid waste streams as well as accelerating conversion of the material. Such treatments may play an important role in helping to keep PLA waste out of sanitary landfills. The ability to easily compost PLA and/or other biopolymers helps to complete the cycle that is the very essence of sustainability.

CHAPTER 8 RECOMMENDATIONS FOR FUTURE WORK

Main recommendations for future work are:

- Evaluate steam-treated PLA biodegradation in real composting conditions where temperature varies.
- Evaluate lactic acid recovery from a plastic waste downstream containing PLA material, by using steam treatment.
- Find selective microbial strains capable to optimize PLA biodegradation under aerobic, anaerobic and facultative conditions.
- Investigate other ways to recover lactic acid from PLA, such as treating dissolved alkali-treated PLA.

APPENDIX A
CHARACTERISTICS OF THE COMPOST

The compost was originally developed using a standard organic matter feedstock recipe developed in this study. It consisted of freshly cut grass from the University of Florida’s golf course (58%), saw dust (11%), virgin corrugated board (11%) and mature compost (20%). All raw materials were prepared and mixed together in a rotational composter (CompostTwin, Mantis, Southampton PA) placed in a computer controlled environmental chamber (Environmental Growth Chambers, Chagrin Falls, Ohio) at 35°C .This formulation met the requirement of initial optimum nutrient balance carbon/nitrogen ratio of 30. Periodic addition of water provided appropriate moisture content between 55% and 70% to promote and maintain biological activity. Initial net weight in the composter was 118 lb and rotation was applied daily to ensure adequate mixing and aeration. Main features of the 3 months old mature compost are shown in Table A-1.

Table A-1. Characteristics of prepared mature compost

Features	Value	Method
Moisture	47-53 %	Weight of dry matter/ initial weigh (105°C)
Ash	22-27 %	Weight of residue after 550° for 6 hours
Volatile solids	21-24 %	VS = 100 – %Moisture - %Ash
Size	4.6 mm, max	Manual screening
pH	6.8	pH-meter, dilution 1:5
CO ₂ generation rate	0.14 moles/day/Kg(*)	Flow method, variable depending on age

(*) Estimated using the flow method at 3 months old.

APPENDIX B
PERMEABILITY TO CARBON DIOXIDE

To determine the permeability of the plastic film to CO₂, the cells of the oxygen transmission rate analyzer Oxtran 2/20 ST (Mocon, Inc., Minneapolis MN) were modified in order to connect to the carbon dioxide sensor of the headspace analyzer Pac Check[®] 650 (Mocon, Inc., Minneapolis MN). Carbon dioxide was used in place of oxygen, and the carrier gas was N₂/H₂ (96/4). A sketch of the system is shown in Figure B-1.

Permeability to CO₂ at 15, 25 and 35°C was estimated using Equation B-1 after carbon dioxide concentration, [CO₂], measured by the sensor, became constant (steady state). The thickness of the film, E, was measured with a micrometer and was 3.035 mil with an area of 100 cm². The universal gas constant is R = 82.057 atm-cc/mol°K. The gas flow was set at 20cc/min (at 21.1°C, 1atm) using needle valves of the Oxtran 2/20 ST.

$$P_{CO_2} = \frac{\text{Flow}_{\text{gas}} \times [\text{CO}_2] \times E}{R T A} \quad (\text{B-1})$$

Permeability to CO₂ at 58°C was estimated using Arrhenius equation shown in Equation B-2, with E_a = 23.08 KJ/mol and pre-exponential factor P_o = 58614 mol-mil/atm-d-m². The final value obtained was P_{CO₂} @ 58°C = 13.41 mol-mil/atm-d-m².

$$P = P_o \exp(-E_a / RT) \quad (\text{B-2})$$

Parameters of the Arrhenius equation, E_a and P_o, were determined from linearization of experimental data of permeability at 15, 25 and 35°C. The slope of the plot ln P_{CO₂} vs 1/T is equal to -E_a/R, and the intercept is ln P_o (Figure B-2). The gas constant R for the Arrhenius equation was R = 0.0083 KJ/°K-mol.

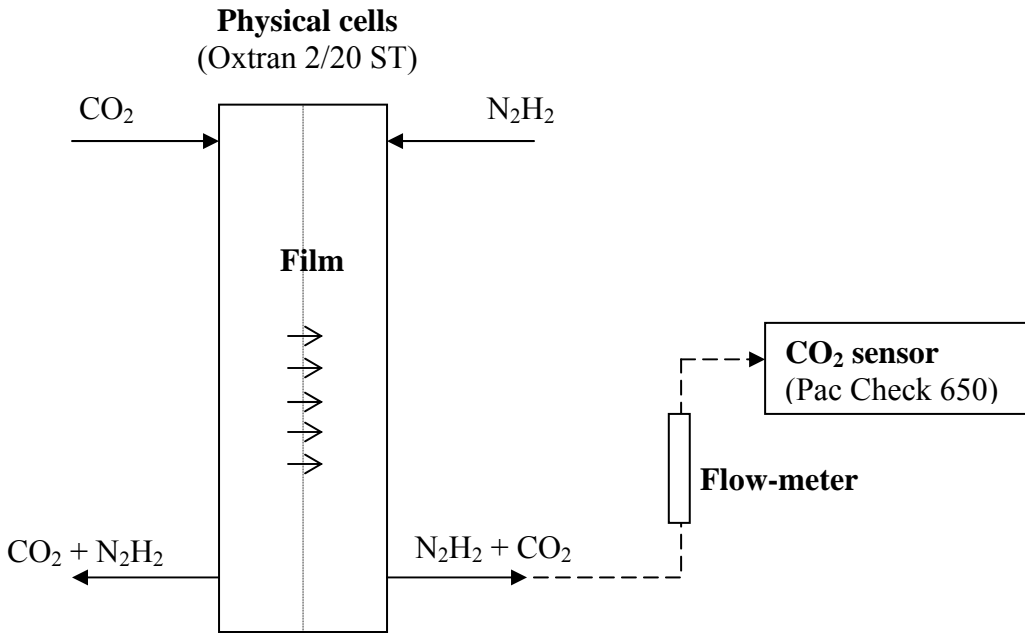

Figure B-1. Mounted system to determine CO₂ transmission rate

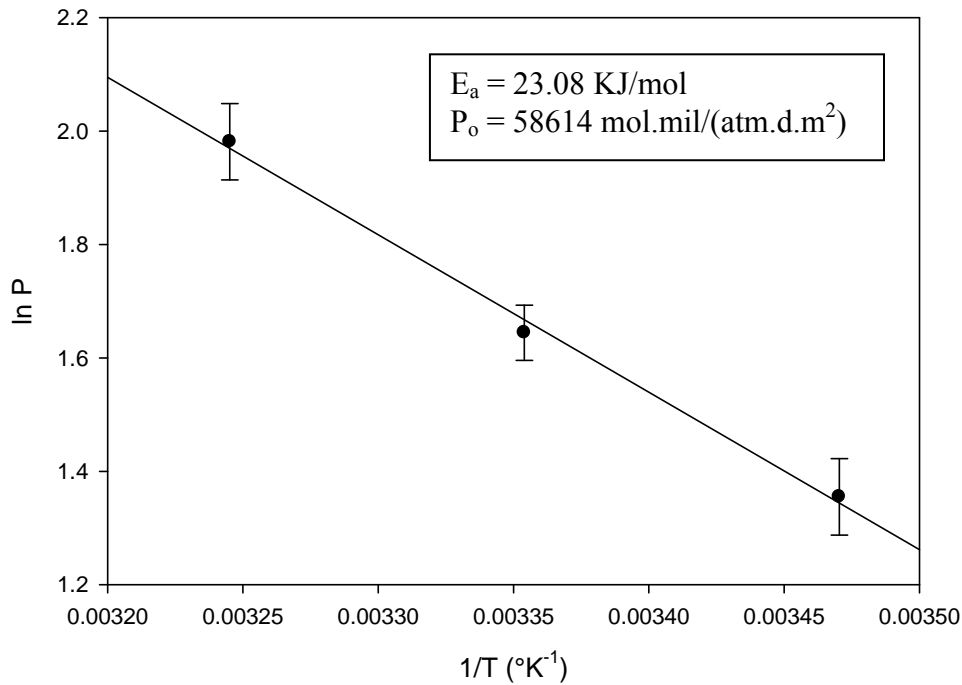

Figure B-2. Arrhenius plot for activation energy determination (CO₂ permeability)

APPENDIX C VOLUME OF BIOMASS

Volume of biomass inside a container was determined from weight of biomass and its density (Equation C-1).

$$V = \frac{W_{\text{biomass in container}}}{\rho_{\text{biomass}}} \quad (\text{C-1})$$

To determine density, a biomass sample was inserted and compacted into a vessel of known weight and volume. Then the filled vessel was weighed and the density was calculated by the ratio of net weight over volume, as shown in Equation C-2.

$$\rho = \frac{W(\text{vessel full}) - W(\text{vessel empty})}{V_{\text{vessel}}} \quad (\text{C-2})$$

The vessel used in these analyses was a bottle cap with weight = 5.8728 g and capacity (volume) = 6.3 cc.

APPENDIX D BAG VOLUME

Bag volume refers to the internal volume occupied by headspace gases and biomass. Bag volume, V_{bag} , was determined by total volume, $V_{bag\ tot}$, minus the volume of the film itself, V_{film} (Equation D-1).

$$V_{bag} = V_{bag\ tot} - V_{film} \quad (D-1)$$

Total volume, $V_{bag\ tot}$, was measured using a volume-meter designed and built for this study, and uses the principle of water displacement. Figure D-1 describes functionality. Water warmed to experimental conditions (e.g. 58°C) was used as the displacement fluid. Errors due to depth pressure were predicted to be minimal (< 0.1%).

Volume of the film was calculated by multiplying length by width by thickness of the opened bag. This was about $V_{film} = (12+12)(9)(3.035 \times 0.00254) = 1.67\text{ cm}^3$.

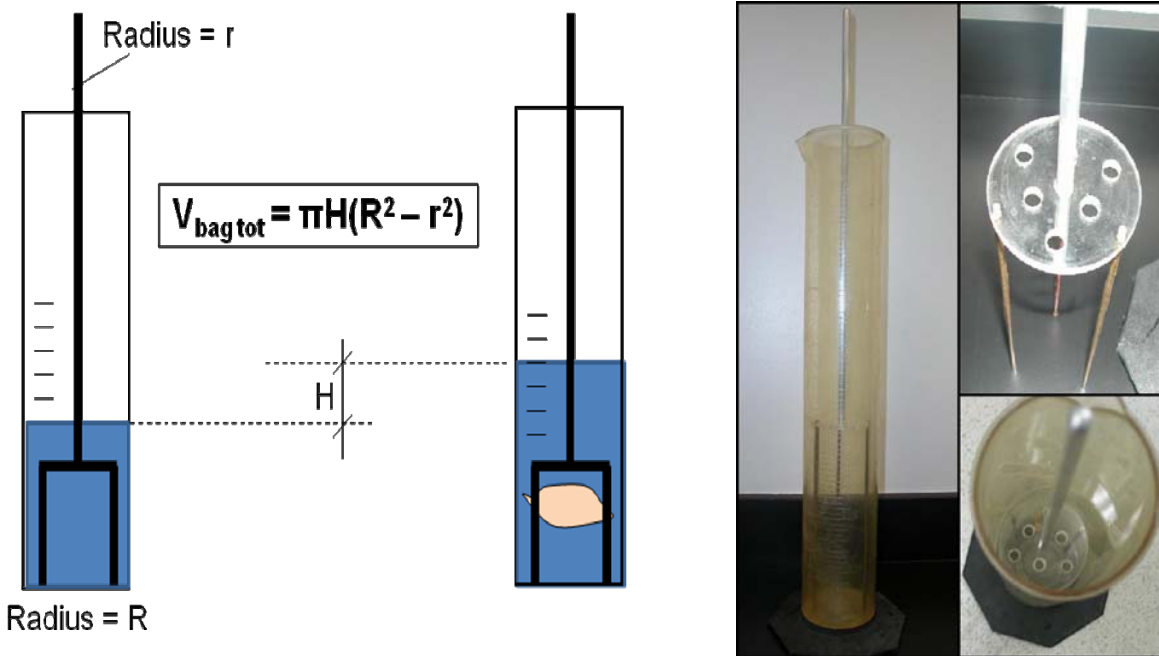

Figure D-1. Volume-meter designed for bag volume determination.

APPENDIX E
OVERALL COEFFICIENT OF DIFFUSION

Jars (cap.936cc) with same features as those used for the method of perforated jars (biodegradation assessment) were filled with 20ml of DI water and some carbon dioxide. Jars were closed using the 5-hole perforated lids and stored in a Lab-Line[®] L-C Incubator (Lab-Line Instruments, Inc., Melrose Park, IL) at 58°C for 5.5 hours. Each 0.5 h, the headspace was analyzed for CO₂ concentration and the rate of effusion was estimated. Results are shown in Table E-1.

The percentage of CO₂ adjusted was obtained from the empirical exponential model that best-fitted experimental data. Only those values where %CO₂ was below 5.7% were taken into account for the regression since they better represented values in normal assessments. The parameters of the model were obtained in MS Excel, with r-square of 0.998 (Figure E-1).

Volume of CO₂ adjusted in the headspace expressed in cubic centimeters, is the product of the CO₂ concentration adjusted by the volume of the headspace (936 – 20 = 916cc). Then, the number of moles was determined by the Ideal Gases Law (moles = PV/RT) assuming that expansion of water due to temperature was negligible. Finally, the rate of effusion was calculated by Equation E-1.

$$\text{Effusion rate} = \frac{\Delta \text{moles in } hs}{\Delta \text{time}} \quad (\text{E-1})$$

Effusion rate was plotted against %CO₂ in the headspace (Figure 4-12) and the following relationship was found (Equation E-2);

$$\text{Effusion rate} = 0.00031 (\%CO_2) \quad (\text{E-2})$$

Equation E-2 shows that the overall coefficient of diffusion is 0.00031 moles CO₂/h per percentage unit.

Table E-1. Carbon dioxide effusion rate estimation through 5-hole lid

Time (h)	%CO ₂ exp.	%CO ₂ adj.	cc CO ₂ adj.	moles CO ₂ in hs	Effusion rate moles CO ₂ /h released
0.0	28.1	38.8	355.3	0.01308	
1.0	15.9	18.3	167.7	0.00617	0.00691
1.5	11.2	12.6	115.2	0.00424	0.00386
2.0	7.8	8.6	79.1	0.00291	0.00265
2.5	5.7	5.9	54.3	0.00200	0.00182
3.0	4.1	4.1	37.3	0.00137	0.00125
3.5	2.9	2.8	25.6	0.00094	0.00086
4.0	1.9	1.9	17.6	0.00065	0.00059
4.5	1.4	1.3	12.1	0.00045	0.00041
5.0	0.9	0.9	8.3	0.00031	0.00028
5.5	0.6	0.6	5.7	0.00021	0.00019

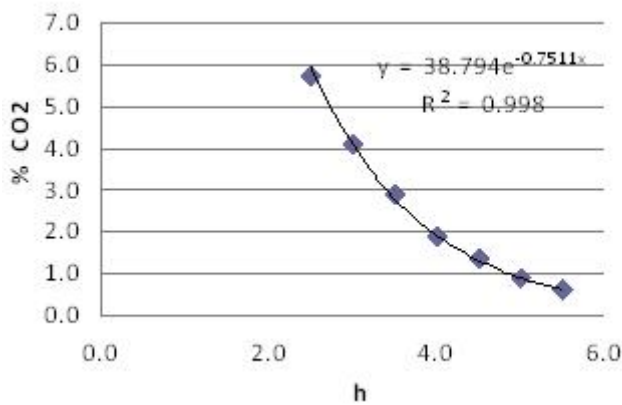

Figure E-1. Carbon dioxide concentration in headspace over time

APPENDIX F
NUTRIENT FORMULA FOR ANAEROBIC MEDIA

Table F-1. Anaerobic media formulation

Chemical	Concentration (g/L)	Amount
Resazurin	1	1.80 ml
(NH ₄) ₂ HPO ₄	26.7	5.40 ml
Ca Cl ₂ ·2H ₂ O	16.7	27.00 ml
H ₃ BO ₃	0.38	2.70 ml
H ₂ WO ₄	0.007	0.27 ml
FeCl ₂ ·4H ₂ O	370	18.00 ml
Na ₂ S·9H ₂ O	500	18.00 ml
Biotin	0.002	1.80 ml
Folic acid	0.002	0.90 ml
Vitamin B12	0.0001	0.18 ml
Sodium bicarbonate		8.40 g
DI water		Up to 2 L

LIST OF REFERENCES

1. Glavic P, Luckman R. Review of sustainability terms and their definitions. *Journal of Cleaner Production* 2007; 15(18):1875-1885.
2. Goldstein N, Olivares C. What's what and who's who in compostable products? *Biocycle* 2007; 48(7):38-47.
3. Kale G, Auras R, Singh S. Degradation of commercial biodegradable packages under real composting and ambient exposure conditions. *Journal of polymers and the Environment* 2006; 14:317-334.
4. Massardier-Nageotte V, Pestre C, Cruard-Pradet T, Bayard R. Aerobic and anaerobic biodegradability of polymer films and physico-chemical characterization. *Polymer Degradation and Stability* 2006; 91(3):620-627.
5. Greer D. Plastics from plants, not petroleum. *Biocycle* 2006; 47(6):33-35.
6. Plackett DV, Holm VK, Johansen P, Ndoni S, Nielsen PV, Sipilainen-Malm T, Södergård A, Verstichel S. Characterization of L-poly(lactide) and L-poly(lactide)-polycaprolactone co-polymer films for use in cheese-packaging applications. *Packaging Technology and Science* 2006; 19(1):1-24.
7. Holm VK, Ndoni S, Risbo J. The stability of poly(lactic acid) packaging films as influenced by humidity and temperature. *Journal of Food Science* 2006; 71(2):40-44.
8. Ohkita T, Lee S. Thermal degradation and biodegradability of poly (lactic acid)/ corn starch biocomposites. *Journal of Applied Polymer Science* 2006; 100(4):3009-3017.
9. Royte E. Corn plastic to the rescue. *Smithsonian* 2006; 37(5):84-88.
10. Auras R, Harte B, Selke S. An overview of polylactides as packaging materials. *Macromolecular Bioscience* 2004; 4(9):835-864.
11. Nugroho P, Mitomo H, Yoshii F, Kume T. Degradation of poly(L-lactic acid) by γ -irradiation. *Polymer Degradation and Stability* 2001; 72(2):337-343.
12. Loo JSC, Ooi CP, Boey FYC. Degradation of poly(lactide-co-glycolide) (PLGA) and poly(L-lactide) (PLLA) by electron beam radiation. *Biomaterials* 2005; 26(12):1359-1367.
13. Yew GH, Mohd Yusof AM, Mohd Ishack ZA, Ishiaku US. Water absorption and enzymatic degradation of poly(lactic acid)/rice starch composites. *Polymer Degradation and Stability* 2005; 90(3):488-500.
14. Jung JH, Ree M, Kim H. Acid- and base- catalyzed hydrolyses of aliphatic polycarbonates and polyesters. *Catalysis Today* 2006; 115(1-4):283-287.

15. American Society for Testing and Materials, ASTM D2857. Standard practice for dilute solution viscosity of polymers; 1996.
16. Dorgan JR, Janzen J, Knauss DM, Hait SB, Limoges B, Hutchinson MH. Fundamental solution and single-chain properties of polylactides. *Journal of Polymer Science: Part B: Polymer Physics* 2005; 43(21):3100-3111.
17. Hill DJT, Milne KA, O'Donnell JH, Pomery PJ. A recent advance in the determination of scission and cross-linking yields of gamma-ray irradiated polymers. In *Irradiation of Polymers, Fundamental and Technological Applications*. Clough RL and Shalaby SW, editors. ACS Symposium Series 620; 1996.p 130-138
18. Busfield WK, Watson GS. Radiation Chemistry of Polybutene-1. In *Irradiation of Polymers, Fundamental and Technological Applications*. Clough RL and Shalaby SW, editors. ACS Symposium Series 620; 1996.p 74-80.
19. De Souza C, Sibata C, Calda L. Evaluation of depth-ratio and backscattering-factor methods in quality control measurements of electron beam energies. *Applied Radiation and Isotopes* 2005; 63(2):217-222.
20. Chung-Chung Y, Rekha PD, Arun AB. What happens during composting? In *Compost Production: A Manual for Asian Farmers*. Zueng-Sang Ch, Bejosano-Gloria C, editors. FFT-ASPAC; 2005. p 8-19.
21. Osaili T, Shaker R, Abu AH, Ayyash M, Martin E. Inactivation of *Enterobacter sakasaki* in infant milk formula by gamma irradiation: determination of D₁₀-value. *Journal of Food Science* 2007; 72(3):M85-M88.
22. Romero M, Mendonca A, Ahn D, Wesley I. Influence of dietary vitamin E on behavior of *Listeria monocytogenes* and color stability in ground turkey meat following electron beam irradiation. *Journal of Food Protection* 2005; 68(6):1159-1164.
23. Mahmoud B, Bhagat A, Linton R. Inactivation kinetics of inoculated *Escherichia coli* O157:H7, *Listeria monocytogenes* and *Salmonella enterica* on strawberries by chlorine dioxide gas. *Food Microbiology* 2007; 24(7-8):736-744.
24. Reeve M, McCarthy S, Downey M, Gross R. Polylactide stereochemistry: effect on enzymatic degradability. *Macromolecules* 1994; 27(3):825-831.
25. Drumright RE, Gruber PR, Henton DE. Polylactic acid technology. *Advanced Materials* 2000; 12(23):1841-1846.
26. Auras RA, Singh SP, Singh JJ. Evaluation of oriented poly(lactide) polymers vs. existing PET and oriented PS for fresh food service containers. *Packaging Technology and Science* 2005; 18(4):207-216.

27. Bowmer TN, Cowen LK, O'Donnell JH and Winzor DJ. Degradation of polystyrene by gamma irradiation: effect of air on the radiation-induced changes in mechanical and molecular properties. *Journal of Applied Polymer Science* 1979; 24(2):425-439.
28. Akin-Oktem G, Tanrisinbilir S, Tincer T. Study on mechanical properties of perlite-filled gamma-irradiated polypropylene. *Journal of Applied Polymer Science* 2001; 81(11): 2670-2678.
29. Shintani H, Kikuchi H, Nakamura A. Effects of gamma-ray irradiation on the change of characteristics of polyurethane. *Journal of Applied Polymer Science* 1990; 41(3-4): 661-675.
30. Ho K, Pometto A. Effects on electron-beam irradiation and ultraviolet light (365nm) on polylactic acid plastic films. *Journal of Environmental Polymer Degradation* 1999; 7(2): 93-100.
31. Carswell-Pomerantz T, Dong L, Hill DJT, O'Donnell JH, Pomery P. Mechanistic studies on the radiation chemistry of poly(hydroxybutyrate). In: *Irradiation of Polymers, Fundamentals and Technological Applications*. Clough RL and Shalaby SW, editors. ACS Symposium Series 620; 1996. p 11-27.
32. Miguez J, Biasotto E, Da Costa E, Bruno M. Influence of γ -irradiation on poly(methyl methacrylate). *Journal of Applied Polymer Science* 2002; 85(4):886-895.
33. Surh M, Sturgeon J, Wolfer W. Radiation swelling behavior and its dependence on temperature, dose rate, and dislocation structure evolution. *Journal of Nuclear Materials* 2005; 336(2-3):217-224.
34. Södergård A, Stolt M. Properties of lactic acid polymers and their correlation with composition. *Progress in Polymer Science* 2002; 27(6):1123-1163.
35. Loo SCJ, Ooi CP, Boey YCF. Influence of electron-beam radiation on the hydrolytic degradation behavior of poly(lactide-co-glycolide)(PLGA). *Biomaterials* 2005; 26(18):3809-3817.
36. Lunt J. Large-scale production, properties and commercial applications of polylactic acid polymers. *Polymer Degradation and Stability* 1998; 59(1-3):145-152.
37. Painter P, Coleman M, editors. *Fundamentals of Polymer Science*. Technomic Publishing; 1997. p 53-81.
38. Chaupart N, Serpe G, Verdu J. Molecular weight distribution and mass changes during polyamide hydrolysis. *Polymer* 1997; 39(6-7):1375-1380.
39. Tsuji H, Daimon H, Fujie K. A new strategy for recycling and preparation of poly(L-lactic acid): hydrolysis in the melt. *Biomacromolecules* 2003; 4(3):835-840.

40. Campanelli J, Kamal M, Cooper D. A kinetic study of the hydrolytic degradation of polyethylene terephthalate at high temperatures. *Journal of Applied Polymer Science* 1993; 48(3):443-451.
41. American Society for Testing and Materials, ASTM D5338. Standard test method for determining aerobic biodegradation of plastic materials under controlled composting conditions; 1996.
42. Robertson GL, editor. *Food packaging Principles and Practice*. Taylor and Francis Group; 2006. p 55-78.
43. Tsimpanogiannis IN, Yortsos YC. Model for the gas evolution in a porous medium driven by solute diffusion. *AIChE Journal* 2002; 48(11):2690-2710.
44. Park M, Ikenaga H, Watanabe K. Phage diversity in a methanogenic digester. *Microbial Ecology* 2007; 53(1): 98-103.
45. Svein JH, Kjetill O. Alginate lyase activity and acidogenesis during fermentation of *Laminaria hyperborea*. *Journal of Applied Phycology* 2001; 13(2):143-152.
46. American Society for Testing and Materials, ASTM E1196. Standard test method for determining the anaerobic biodegradation potential of organic chemicals; 1996.
47. Shin PK, Kim MH, Kim JM. Biodegradability of degradable plastics exposed to anaerobic digested sludge and simulated landfill conditions. *Journal of Environmental Polymer Degradation* 1997; 5(1):33-39.
48. Wagner W, Pruss A. International equations for the saturation properties of ordinary water substance. *Journal of Physical and Chemical Reference Data* 1993; 22(3):783-787.
49. De Wilde B, Boelens J. Prerequisites for biodegradable plastic materials for acceptance in real-life composting plants and technical aspects. *Polymer Degradation and Stability* 1998; 59(1-3):7-12.

BIOGRAPHICAL SKETCH

I was born in Lima, Peru, in 1970 where I lived almost all my life. I graduated as Food Engineer (1992) and MS in Food Technology (1997), both at Universidad Nacional Agraria la Molina in my home country. In 1995, I married and became a professor at the Food Engineering Department in my former university. I spent 10 years of my life teaching, training, managing and researching in the area of food engineering. In 2005, I was awarded a fellowship granted by the Organization of the American States (OAS) to pursue the Ph.D. program at University of Florida through the Agricultural and Biological Engineering Department / Packaging Science Program. I have spent my last three years studying topics related to packaging and doing research in the field of biodegradable packaging, under Dr. Bruce Welt.