



UNIVERSITY OF GENOA  
DICCA

Department of Civil, Chemical, and Environmental Engineering



PHD COURSE IN:

FLUIDYNAMICS AND PROCESSES OF ENVIRONMENTAL  
ENGINEERING  
(CICLE XXV)

**“LARGE-SCALE WASTEWATER TREATMENT PLANT WITH  
ENERGY VALORIZATION OF SEWAGE SLUDGE”.**

PhD student: Chávez Romero Zaida Brenilda  
Genoa, March 2013.

## CONTENTS

<b>INTRODUCTION</b> .....	4
<b>CHAPTER 1: WATER SITUATION IN THE WORLD AND PERU</b> .....	6
1.1. The water problem.....	6
1.2. The energy problem.....	9
<b>CHAPTER 2: CASE STUDIES: DIVERSE KIND OF WASTEWATER TREATMENT PLANTS</b> .....	13
2.1. Case Study 1: Italy.....	13
2.1.1. Novi Ligure (AL).....	13
2.2. Case study 2: South America .....	18
2.2.1. Bucaramanga, Colombia.....	18
2.2.2. Chiclayo, Peru.....	23
2.3. Comparisons of cases study.....	26
2.4. Discussion.....	28
<b>CHAPTER 3: WASTEWATER TREATMENT: LARGE-SCALE PLANT PLANNING</b> ....	30
3.1. Project data.....	30
3.1.1. Population.....	30
3.1.2. Flow rate: domestic and improper water: rain water.....	31
3.1.3. Organic load concentration: BOD <sub>5</sub> .....	32
3.1.4. Organic load concentration: COD.....	33
3.1.5. TSS and Faecal Coliform concentration .....	33
3.1.6. pH.....	34
3.1.7. Temperature and Hydraulic retention time (HRT) .....	35
3.2. Description of the new treatment cycle proposal .....	36
3.2.1. Sewage treatment.....	36
3.2.2. Biogas treatment.....	38
3.2.3. Sludge treatment.....	39
3.3. Sizing plant.....	40
3.3.1. Sewage treatment.....	40
3.3.1.1. Preliminary treatment.....	40
3.3.1.2. Biological treatment: UASB reactors.....	51
3.3.1.3. Post-treatment .....	60
3.3.2. Sludge treatment.....	63
3.3.2.1. Sludge production and discharge frequency.....	63
3.3.2.2. Sludge drying beds.....	66
3.3.2.3. Sludge utilization.....	67
3.3.3. Biogas treatment.....	68
3.3.3.1. Biogas production.....	69
3.3.3.2. Desulphurization .....	70
3.3.3.3. Energy production and utilization .....	71
3.3.4. Final discharge of sewage .....	72
3.4. Discussion.....	74

<b>CHAPTER 4: PRE-TREATMENT OF SEWAGE SLUDGE: FOCUS ON DIFFUSION MOISTURE COEFFICIENT CALCULATION.....</b>	<b>76</b>
4.1. Experimental procedure.....	77
4.1.1. Sterilization process.....	77
4.1.2. Drying process.....	77
4.2. Mathematical approach.....	79
4.2.1. Drying process of layer symmetry.....	79
4.2.2. Procedure for optimization process.....	81
4.2.3. Equilibrium Moisture Content (EMC) models.....	82
4.3. Experimental results.....	83
4.4. Simulations results.....	85
4.4.1. On the case of constant diffusion coefficient.....	85
4.4.2. On the case of non-constant diffusion coefficient: the optimization process...	88
4.5. Discussion.....	93
<b>CHAPTER 5: ENERGY VALORIZATION OF SEWAGE SLUDGE: GASIFICATION PROCESS SIMULATION .....</b>	<b>95</b>
5.1. Energy recovery from sewage sludge.....	95
5.2. Composition of sewage sludge.....	98
5.3. Drying sludge.....	99
5.4. Gasification of sewage sludge.....	102
5.5. Types of gasification technologies.....	103
5.5.1. Fixed bed reactors.....	104
5.5.2. Fluidized bed reactors.....	105
5.5.3. Comparison of types of gasifiers.....	107
5.6. Simulations activity of gasification.....	109
5.6.1. Simulation results.....	112
5.6.1.1. Isothermal reactor.....	112
5.6.1.2. Adiabatic reactor.....	118
5.6.1.3. Adiabatic reactor considering the kinetic constraints.....	123
5.6.1.4. Gasification of sewage sludge with agricultural biomass.....	124
5.7. Discussion.....	127
<b>CHAPTER 6: FINAL CONSIDERATIONS.....</b>	<b>129</b>
6.1. Total energy production.....	129
6.2. Summary of the work and conclusions.....	129
6.3. Future developments.....	131
6.4. References.....	132
<b>ANNEXES.....</b>	<b>139</b>
Annex 1: Wastewater Treatment Processes.....	139
Annex 2: Environmental Impact Assessment (EIA) of the Proposal.....	160
Annex 3: MathCAD Procedure.....	169

## INTRODUCTION

The problem of domestic sewage treatment and wastes from the process is becoming more complex and difficult to manage. Often easy solutions for disposal of both elements have been implemented, but without provision of contingent plans. Technological advances have resulted in the development of new methods and processes for treatment and disposal of wastewater and sewage sludge as well as new alternative energy sources to the fossil fuel from the bio solid wastes from the sewage treatment.

Successful experiences on treatment, disposal and beneficial uses of sewage and sewage sludge from developed countries as Italy are being taken account for the development of proposals of improve sewage treatment and sludge disposal in developing countries as Peru. And, it is in this context where this research is involved: Studying specific examples of sewage treatment, proposing an alternative treatment in a Peruvian community and developing techniques to obtain energy from sewage treatment wastes.

The geographic situation of Peru and particularly Chiclayo city permits the presence of wastewater treatment plants (WWTP) for coastal cities with subsequent treated effluent discharges into the sea. Many factors as lack of investment in this sector, the need of qualified personnel, high operative costs and so on make that the best solution must be the simplest and most economic. However the effluents not always have the level required by law.

Suitable techniques for the upgrading must be very effective and economically convenient. An attractive option can be the Up-flow Anaerobic Sludge Blanket (UASB) reactor adapting to the stabilization ponds due to its advantages such as the production and capture of the biogas from anaerobic digestion, established and sulfate-rich organic sludge. This system is a simple process not requiring the use of other equipment such as aerators, requires small capital outlay, low maintenance costs and limited land and energy requirement.

Some UASB applications in Europe have been orientated towards treating industrial sewage, while in Latin America and many developing countries around the world the orientation is towards domestic sewage, both experiences can demonstrated its feasibility and the effluents quality obtained represent an alternative for the reuse with related environmental protection benefits. Moreover, residual sludge can be reduced and used as an energy resource through thermo-chemical processes.

The purpose of this research is to contribute to the improving of the wastewater treatment systems keeping the concepts of simplicity and low cost solutions producing effluents according to local regulations and to highlight the recovering energy from biogas, and bio solids for further applications. According to CEPIS<sup>1</sup>/OPS<sup>2</sup> and other European and international agencies for the sustainable development, energy produced

---

<sup>1</sup> CEPIS is the Spanish acronym for "Pan-American research center for sanitary engineering".

<sup>2</sup> OPS is the Spanish acronym for "Pan-American health organization".

from biomass and residual biomass is the most acceptable option for both developing and developed countries in order to meet electricity demands.

The present work illustrates the results of this three-year research activity involving simulation and experimental activities carried out in Italy and abroad. Some information about the current treatment plants in Italy and Peru has been asked from the corresponding companies; experimental activity about drying sewage sludge was done at the University of Nevada, Reno (UNR) in the United States of America, and Italian experimental data were available for an semi-empirical study about energy valorization of sewage sludge.

Regarding the project of a modernization of Chiclayo's wastewater treatment plant, as will be discussed in chapter 3, the installation of UASB reactors in the San José stabilisation ponds was proposed. In this regard, a study about wastewater characteristics and data project for sizing was done. Then, a concise description of the three lines of treatment proposed is presented. The sizing development has been carried out through simulation activities with HEC-RAS software, excel spreadsheets and AutoCAD designer. The verification of current operational conditions, evaluation of the performance and final efficiencies contrasting with current efficiencies were emphasized. Preliminary studies about environmental impact assessment and economic viability were also considered in order to demonstrate the feasibility of the project.

Previously, in chapter 2, a study about the comparison between sewage treatment plants in different communities with diverse contexts was done: Novi Ligure in Italy, Chiclayo in Peru, and Bucaramanga in Colombia, individuating their importance in this work. Sewage treatment plant of Bucaramanga represents the first successful real-scale plant treating domestic sewage with UASB reactors. Novi Ligure represents an example with sludge treatment and recovering. In fact, a cooperation effort with the wastewater services company of Novi Ligure was set and their technical help and great experience on this sector was very important for the development of our proposal.

In order to valorize the wastes from sewage treatment process, a study about treatment and future applications of sewage sludge was done in two phases: in chapter 4 will discuss experimental and numerical simulation activities about thermal drying sludge carried out in the department of Chemical and Materials Engineering of the UNR, studying the moisture transfer and diffusion coefficient in a slab symmetry. Subsequently, as will discuss in chapter 5, numerical simulations about dried sewage sludge gasification were done in order to demonstrate the useful application of final product of sewage treatment as energy solution alternative.

# CHAPTER 1: WATER SITUATION IN THE WORLD AND PERU

## 1.1. The water problem

Worldwide, problems related water are increasingly recognized as one of the most immediate and serious environmental threats to humanity. One in every six persons has no access to safe drinking water [UN<sup>3</sup>, 2005]. One in every four people in the developing world currently lacks access to an improved water supply, and two in every five people have no access to improved sanitation. It is estimated that 25,000 people died every day due to waterborne diseases [UN, 2005].

The portion of water available for human consumption is less than 1%, and it is necessary by human survival. The availability of drinking water is different in each part of the world, as shown in figure 1.1. Many countries in Africa and Asia have very low or catastrophically low water availability. Almost the total countries in Latin American have very high levels of water availability, and north America and Russia have high level of water availability. European continent presents medium or low levels of water availability, even so, the new report from the EEA<sup>4</sup> highlights the water scarcity and drought in the whole European continent, and confirms that in many parts of Europe water use is unsustainable [EEA, 2009].

In fact, Europe needs to redouble efforts in using water more efficiently. Water shortages have severe consequences for economies reliant on agriculture and industry mainly. Some parts of the continent have even led to drinking water restrictions. Increasingly, there is intense competition for water resources. In the European Union, about a quarter of water diverted from the natural environment is destined for agriculture uses, in southern Europe this percentage can be up to 80%. Public water supply accounts for approximately a fifth of water use and over a quarter of this is used just to flush the toilet. Hydropower installations change the natural structure and flow of rivers and lakes with consequences for ecosystems [EEA, 2012].



Figure 1.1: World water availability in 2005. (Measure in the label in terms of 1000 m<sup>3</sup> per capita/year). Source: [UN, 2005]

<sup>3</sup> UN is the acronym for "United Nations".

<sup>4</sup> EEA is the acronym for "European Environment Agency"

Peru is considered a privileged country because has 5% of the drinking water in worldwide, each Peruvian has approximately 85,000 m<sup>3</sup> of water yearly, when the world annual average is 7,300 m<sup>3</sup> [Garcia-Sayan 2006]. However, this resource is being inadequately used, generating a shortage and lack of water supply in the isolated and poor areas. The 92% of drinking water in Peru is consumed by agriculture, livestock and human consumption as shown in figure 1.2.

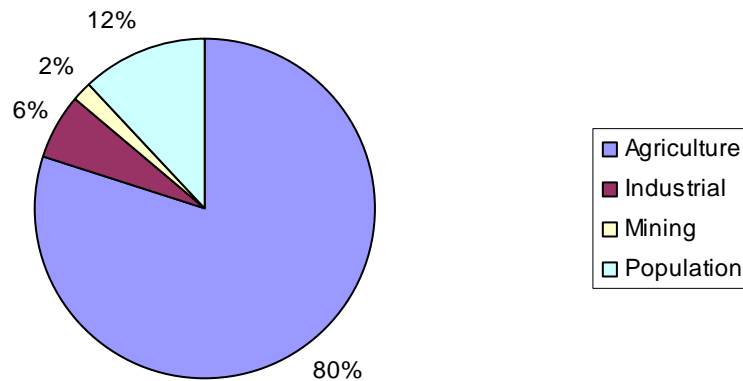

Figure 1.2: Uses of drinking water in Peru. Source: [Vargas, 2009]

Irrigation systems are inefficient and there are no sewage systems, from 97% of crops by floods, only 3% is with tech irrigations. In the Peruvian coast, the water resources are only 2% of all water resources around the country, even so, rice and other crops with very high water consumption are cultivated.

Drinking water surface potential in the country is more than two thousand billions of cubic meters, but this potential decreases year by year as a result of pollution, worst management and melting of Andes mountains. In some parts of the country, the water from glaciers is vital for valleys in the dry seasons.

The water and sanitation sector has made important advances in the last decades. From 27.5 million Peruvian people, 74% resided in urban areas and 26% live in rural areas. In 2004, the coverage of drinking water service was 83% and 63% had access to sanitation. Urban coverage was 89% for water and 74% for sanitation [WHO<sup>5</sup>/UNICEF<sup>6</sup>-JMP<sup>7</sup>, 2010]. In rural areas coverage of drinking water was 65% and sanitation 32%. The ministry of household, construction and sanitation - VIVIENDA<sup>8</sup>, in its National plan of housing and sanitation 2006 - 2015 shows that in urban area, the coverage of drinking water reached 81% in 2005, 84% in 2010 and will be 97% in 2015. Regarding the rural area, the increase of drinking water service will be done with help of international financing.

<sup>5</sup> WHO is the acronym for "World Health Organization".

<sup>6</sup> UNICEF is the acronym for "The United Nations Children's Fund".

<sup>7</sup> JMP is the acronym for "Join Monitoring Program".

<sup>8</sup> VIVIENDA is the Spanish nominative for "Ministerio de vivienda construcción y saneamiento".

Nevertheless, even there are barriers that limited the development: There are deficiencies in water service for a high percentage of population mainly due to the construction of water supply systems is expensive and there are no sufficient resources to serve all population; in addition, several communities and poor human settlements are located in places where to bring drinking water and sewer systems is very expensive [Garcia-Sayan 2006].

Concerning wastewater treatment, 22% of sewage from urban areas was treated in 2005, 54% was predicted for 2010 and 100% for 2015 [VIVIENDA, 2006]. But nowadays, in 2012, more than three fourth of the wastewater generated no receive any type of treatment prior to its final discharge. The great majority of sewage is discharged into the ocean or rivers.

According to SUNASS<sup>9</sup>, Peru requires more complex treatment systems for the industrial wastewater, and needs more investments. MINAM<sup>10</sup> promotes new regulations about beneficial applications for effluents produced by municipal wastewater treatment plants that end up in water bodies. For example, effluents from stabilisation ponds in Chiclayo (Lambayeque) are using for irrigate about 2,000 ha. of sugar cane and rice.

Worldwide, it is calculated that for 6,250 million of inhabitants of the earth, 20% more of water is necessary. 1,100 million of human have no access to drinking water and others 2,400 million have no access to adequate sanitation. The morbidity and mortality resulting from infections related water, such as diarrheal disease, are enormous, particularly young children, [Global Development Alliance, 2008], mainly due to the inadequate management of water resources, ineffective institutions related human resources, shortfalls in financing and lack of sanitation demand [USAID<sup>11</sup>, 2009].

In majority of regions, the problem is not the lack of drinking water, rather, the inefficient management and distribution of water resources [Carrillo et al, 2009]. Many parts of the world do not have the necessary infrastructure to use water, such as lack of canalization of rivers, losses of rain water or losses by through faulty and damage pipes. In other places the quality of water is not adequate for the human consumption because is polluted due to poor management of domestic and industrial wastes [UN, 2007].

Developing countries always find new supplies water sources. But, in poorest places, the problem is often a lack of infrastructure, wells, pipes, pollution controls and systems for disinfection of water, moreover, rural local governments have little expertise or capital. Climate change also plays an important role in the problems of water. The combination of Climate change and poor management of resources are leading to shortage of water.

The solutions can be simples: investment in appropriately scale technology, better governance, community involvement, proper water pricing, and training water users to maintain their systems [Royte, 2010].

---

<sup>9</sup> SUNASS is the Spanish acronym for "Superintendencia Nacional de Servicios de Saneamiento".

<sup>10</sup> MINAM is the Spanish acronym for "Ministerio del Ambiente".

<sup>11</sup> USAID is the acronym for "United States Agency for International Development".



## 1.2. The energy problem

Lack of energy in the world is like lack of water on human. In the last century, 22% of world developed countries population consumed the 73% of commercial energy used worldwide. Currently, developed countries are stabilizing or increasing very little their energy consumption with a more efficiency use, while, developing countries are increasing their consumption because for their progress need more energy.

Europe, for example, reached the peak of energy consumption in 2006; in 2010 energy consumption was nearly 4% lower. Part of this decrease is due to the economic crisis, and a slight decoupling of economic activity from energy consumption [EEA, 2012].

About 77% of the energy needs of the average European are met by oil, gas and coal. Nuclear power provides 14%, and 9% coming from renewable energy sources. But, renewable energy is increasing rapidly; in 2010, solar photovoltaic was the biggest source of new installed capacity, followed by natural gas and wind. Nuclear power had much more capacity decommissioned than installed. The average European uses 27 MW-h annually, including all domestic, industrial and transport sources. It can be varies widely between countries, as well as the CO<sub>2</sub> emissions which depend strongly on the penetration of renewable and nuclear energy [EEA, 2012]. According to Europe 2020 growing strategy, energy constitutes one of the five targets for the European Community in 2020, with the goals of 20% of Europe's energy consumption to come from renewable energy and a 20% increase in energy efficiency [EEA, 2013].

Regarding United States of America, in the publication "AEO<sup>12</sup> 2013 Early Release Overview", about 83.7% of the energy consumption from American derivate from liquid fuel, oil, natural gas and coal, Nuclear power provides 8% and 7.6% is from renewable sources. It is predicted the increase of natural gas, nuclear and renewable sources exploitation [EIA<sup>13</sup>, 2012].

In Latin America countries, about 75% of the energy production coming from oil, coal and natural gas, while renewable sources are extensive exploited, energy from renewable sources is about 23.7%, and nuclear represents only 1.3% [IEA<sup>14</sup> 2011].

In the context of Latin America, the Peruvian energy system is based mainly in natural gas and oil [MEM<sup>15</sup>, 2010]. Natural gas is a resource exploited since 1994, and its reserves are about 60.3% while the oil reserves are about 12.1%. It represents that exists a greater energy production from limited reserves than the plentiful reserves. The use of other feasible renewable sources as photovoltaic, eolic, hydraulic, biomass and geothermal sources are increasing [FONAM<sup>16</sup>, 2008].

---

<sup>12</sup> AEO is the acronym for "Annual Energy Outlook".

<sup>13</sup> EIA is the acronym for "U.S. Energy Information Administration".

<sup>14</sup> IEA is the acronym for "International Energy Agency".

<sup>15</sup> MEM is the Spanish acronym for "Ministerio de Energía y Minas".

<sup>16</sup> FONAM is the Spanish acronym for "Fondo Nacional del Medio Ambiente".

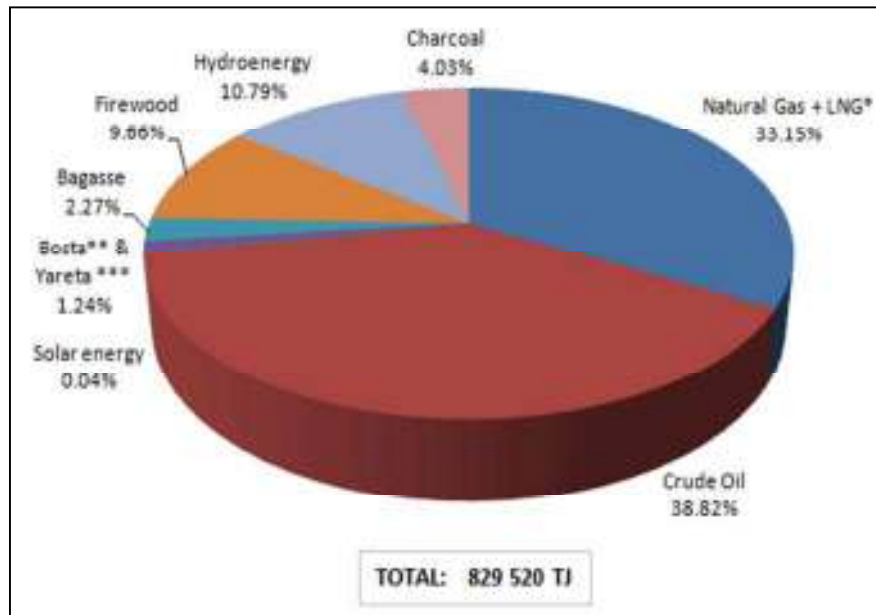

\* LGN = Liquid natural gas (fiscalized production).

\*\* Bosta is excrement of cattle and horses.

\*\*\* Yareta is a tiny flowering plant in the family Apiaceous native to South America. Yareta is an evergreen perennial being in leaf all year.

Figure 1.3: Peruvian structure of primary energy production in 2009.

Source: [MEM, 2010]

Commercial energy is coming from crude oil, hydro-energy, natural gas and charcoal and represents the 82.7% of total primary energy production. Solar energy is using as a solar thermal or photovoltaic, especially in rural communities for telecommunication, electrification systems, education, and clinics or health center services.

Currently this system is not sustainable and unequal. Many Peruvian forest cities have limited access to the electricity and about 45% of housing have no electricity access [Arroyo et al, 2005]. In other big cities, the use of fossil fuels causes enormous greenhouses emissions causing serious problems of air pollution.

Electricity demand has been an average annual growth of 8% due to the intensive development of mining and manufacturing activities, and the investments in electricity has been average annual rate of 27%. The necessity of accelerating the implementations of new projects for ensures electricity supply, but promoting a sustainable use of energy sources for the environment preservation is urgent [MEM, 2009]. MEM has planned start projects of thermal power plants to natural gas for the medium term and hydraulic power for the long term [MEM, 2009], as well as, eolic, biomass and solar.

There are 42 power stations over 20 MW that works by national grid and have a total capacity of 5,585 MW. This group is composed of 21 hydroelectric stations with a total capacity of 2,927 MW and 20 thermo-electrical stations with a total capacity of 2,658 MW. In thermo-electrical stations, 6 projects with natural gas and have a total capacity of 1,719 MW. The energy participation of these resources has an average annual growth of 54% [MEM, 2009].

### 1.3. Renewable energy sources

Worldwide, the demand of energy provision is increase very quickly. Electricity is generating mainly from oil and coal, but in the last years, other fuels as Natural gas, hydro, nuclear and renewable sources are increasing their production and transformation, as shown in Figure 1.4.

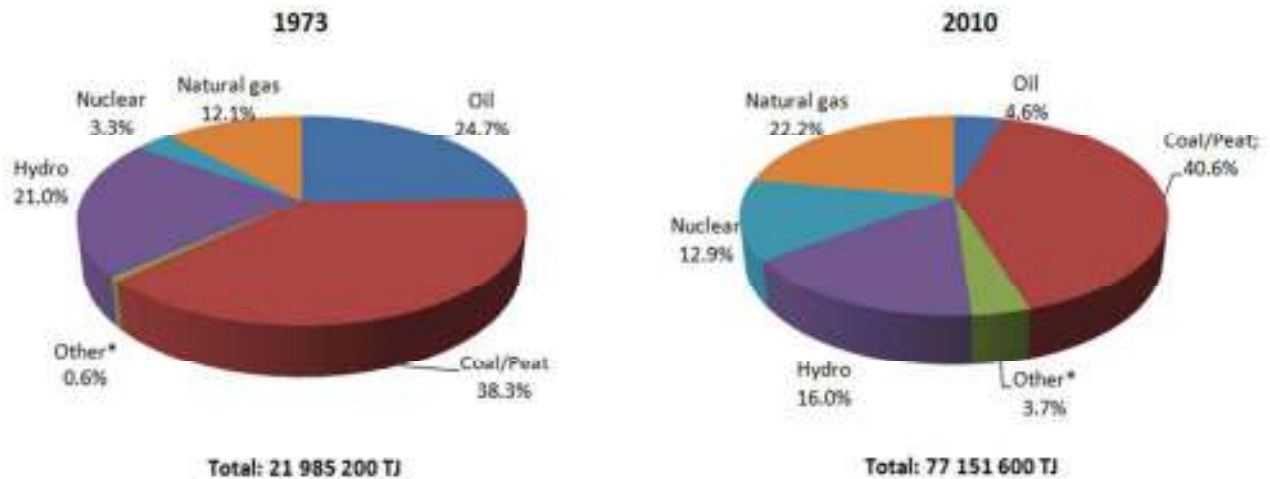

\*\* Others included geothermal, solar, wind, heat, biofuel and waste.

Figure 1.4: World electricity generation in 1973 and 2010. Source: [IEA, 2012]

However, sources as nuclear power are not accessible to the vast majority of the world, while, renewable energy sources are easily accessible to mankind around the world. Renewable energy is not only available in a wide range, but, also abundant in nature.

About 90% of energy from renewable resources is produced and consumed in developing countries. More than 40% of biomass is located in South America, out of which, 55% is used directly as fuel or split firewood, and 45% is used as industrial raw material suitable for energy generation. Biomass and other renewable sources represent 14% of energy contribution, but in developed countries represents only 3%, while in developing countries represent 35%, especially in rural areas where often the biomass is the only accessible and affordable energy source.

Wind energy represents about 0.3% of the global installed capacity of electric, but it supplies only about 0.1% of total global energy [Varun et al, 2009]. Installed wind capacity is rapidly increasing in the last years, especially in the European Union countries. The global annual installed wind capacity was 37,466 MW in 2009, up from 3,760 MW in 2000 [EWEA<sup>17</sup>, 2010].

The solar Photovoltaic market has been increasing over the last years and is forecasted to confirm this turned in the coming years. By the end of 2011 the global cumulative capacity was 69,684 MW. The European Union contributes about 74% of the global

<sup>17</sup> EWEA is the acronym for European Wind Energy Association.

cumulative capacity. The global annual installations by the end of 2011 were 29,665 MW up from 277 MW in 2000. It is estimated that today over 4.5 million households in Europe get electricity from solar photovoltaic [EPIA<sup>18</sup>, 2012]. Hydro, geothermal, sea power and biomass represent other renewable sources. Hydropower is the renewable resource most ancient use. Biomass is the major source of energy in developing countries and is likely remaining in the future [Rosillo-Calle, 1992 and Hall, 1991].

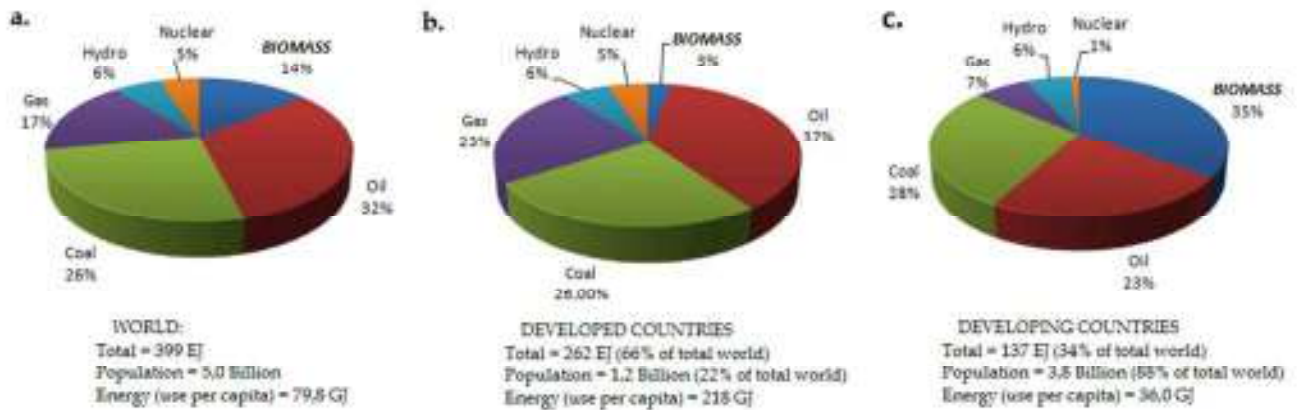

Figure 1.5: The contribution of biomass to global energy-use. Source: [IEA, 2009]

The CO<sub>2</sub> emissions from oil are decreasing in last 30 years, but the emissions from coal/peat is increasing, while, the emissions from biomass and other renewable sources is minimum.

Table 1.3: Emissions from various energy sources

Energy sources	Green-houses gas emission (g/kWh)		
	CO <sub>2</sub>	SO <sub>2</sub>	NO <sub>x</sub>
Coal (best practice)	955	11.8	4.3
Coal (NO <sub>x</sub> ) and FDG*	987	1.5	2.9
Oil (best practice)	818	14.2	4.0
Natural gas (CCGT**)	430	-	0.5
Diesel	772	1.6	12.3
Small hydro	9	0.03	0.07
Large hydro	3.6 - 11.6	0.009 - 0.024	0.003 - 0.006
Wind	7 - 9	0.02 - 0.09	0.02 - 0.06
Solar photovoltaic	98 - 167	0.2 - 0.34	0.18 - 0.30
Solar thermal electric	26 - 38	0.13 - 0.27	0.06 - 0.13
Energy crops - current practice	17 - 27	0.07 - 0.16	1.1 - 2.5
(likely to improve to)	(15 - 18)	(0.06 - 0.08)	(0.35 - 0.51)
Geothermal	7 - 9	0.02	0.28

\* FDG = Flue gas desulphurisation

\*\* CCGT = Combined cycle gas turbines

Source: [Akella et al, 2008]

<sup>18</sup> EPIA is the acronym for European Photovoltaic Industry Association.

## CHAPTER 2: CASE STUDIES: DIVERSE KIND OF WASTEWATER TREATMENT PLANTS

### 2.1. Case Study 1: Italy

#### 2.1.1. Novi Ligure (AL)

Novi Ligure is a town in the province of Alessandria, Piedmont region, of northwest of Italy. Novi Ligure has an area of 750 square kilometers and a population of about 28,581 inhabitants at 2008 [Gestione Acqua, 2010].

The main economic activities are agriculture and industry. Other important activities historically relevant are sericulture or silk farming (production of raw silk). In the part of hill territory, the prevalent activities are silviculture (the practice of controlling the establishment, growth, composition, health, and quality of forests) and viticulture or viniculture (production of wine).

Novi Ligure is an industrial center where the head offices of many enterprises and establishment are presented; such as food and confectionery industries, drugstores and small and medium business. It is well disposed geographically into the industrial triangle composed by Turin, Genoa and Milan.

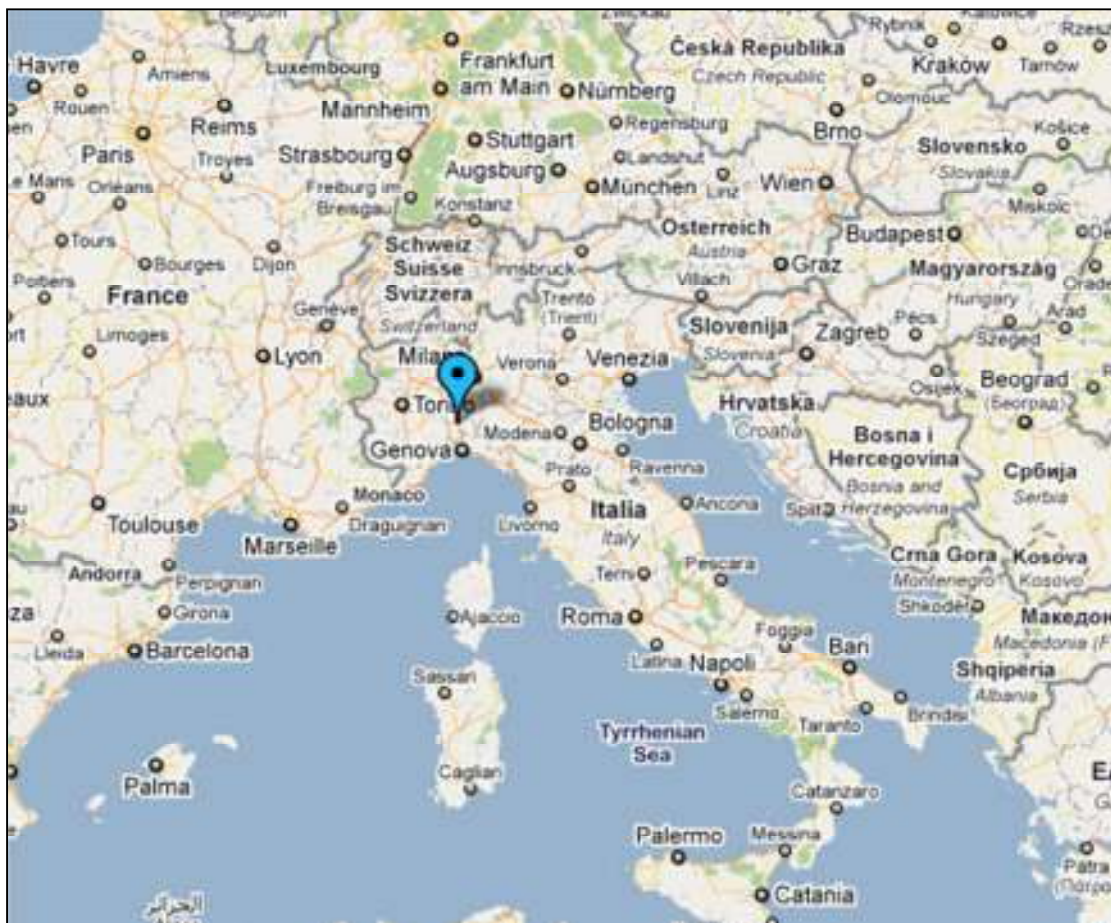

Figure 2.1: Location of Novi Ligure (AL) in Italy and Europe. Source: [Google maps].

Wastewater treatment plant is located at northwest of Novi Ligure in a distance of 600 meters of border with Pozzolo Formigaro (AL), next to Cascinetta farm building, to the north of "Rio Gazzo" waterway which is the receptor stream of treated effluent and to the south of railway Turin - Genoa. The area presents level land with a middle height of 169.50 amsl (above mean sea level).

There are two towns connect to the purifier, Novi Ligure with a population of 25,581 inhabitants and Pozzolo Formigaro with a population of 4,896 inhabitants. The plant is designed for a total capacity of 70,000 inhabitants approximately. The average value of service coverage is 98% for civil population and 100% for industries. The 63.8% of total wastewater is industrial sewage and 36.2% is domestic sewage.

The water depuration treatment is constituted by preliminary treatment (screening and grit removal), primary sedimentation and biological treatment with activated sludge process. Mixed sludge is treated by two-stage mesophilic phase anaerobic digestion, preceded of thickening; the effluent of stabilization phase is subjected to mechanical dehydration, and dehydrated sludge is finally disposed in composting plants. Moreover, a treatment for wastewater reuse in industrial applications is also applied. A satellite view of the Novi Ligure treatment plant is shown in figure 2.2.



Figure 2.2: Satellite view of Novi Ligure's wastewater treatment plant. Source: [Google earth].

The total capacity of the plant is 2,964.6 m<sup>3</sup>/h. A scheme of the treatment process is shown in figure 2.3.

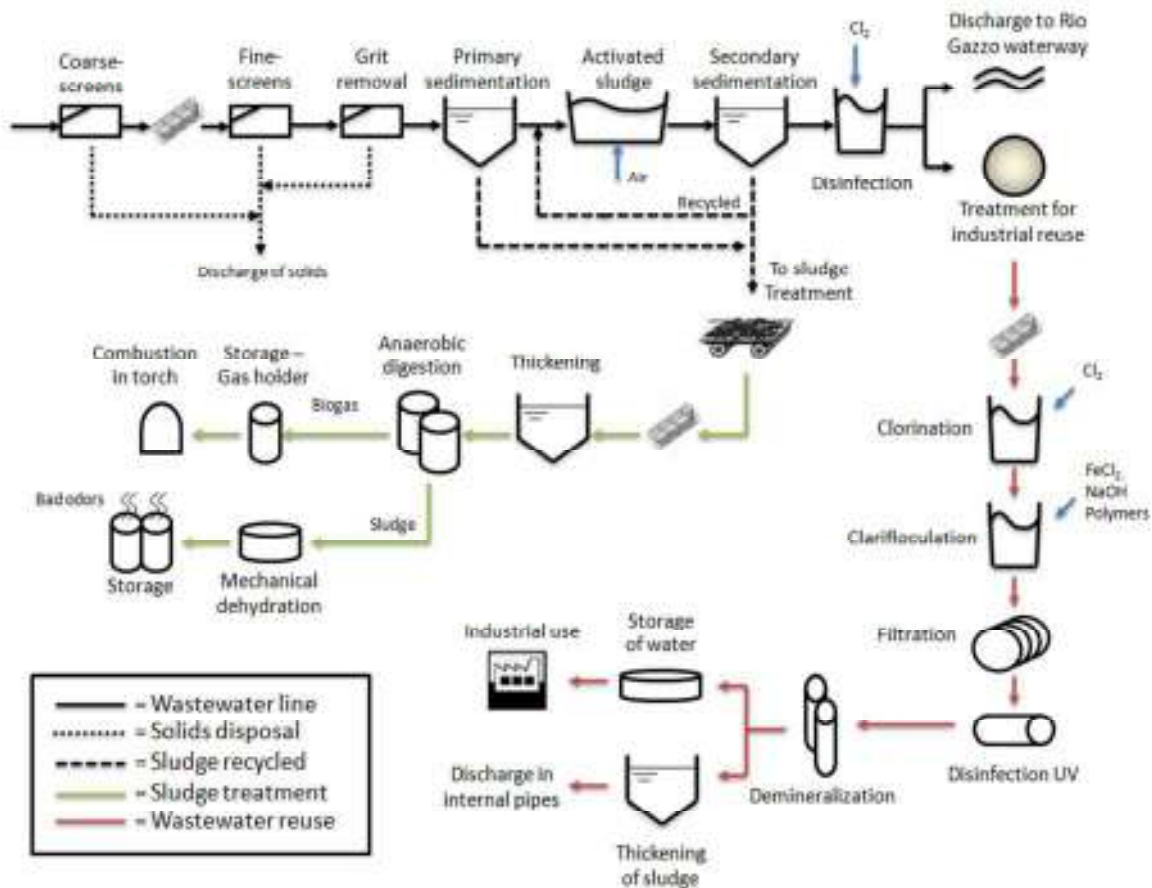

Figure 2.3: Wastewater treatment system of Novi Ligure.

The influent to the treatment plant has follow characteristics: 260.2 mgCOD<sup>19</sup>/l, 152.5 mgBOD<sub>5</sub><sup>20</sup>/l, 109.9 mgTSS<sup>21</sup>/l, 15.92 mgNH<sub>4</sub><sup>+</sup>/l and 1.03 mgP<sub>tot</sub>/l.

Wastewater treatment system is composed by a general by pass, one unit of automatic coarse screens and two units of mechanical fine screens. Coarse screens have a bar interspacing of 0.03 m. and bar size of 0.012 m, while, fine screens have a bar interspacing of 0.016 m [Gestione Acqua, 2010]. Fine screens are a rotary drum type.

Grit, fat and grease are removed in one aerated basin of dimensions 4.00 m width and 30.00 m length and 2.45 m depth with longitudinal flow. The retention time is 14.9 min with a longitudinal velocity of 0.03 m/s. Sand daily production is 0.24 m<sup>3</sup>/d [Gestione Acqua, 2010].

Primary sedimentation is carry out in three parallel lines, each one constituted by a circular basin with upward and radial flow. Each basin have follow dimensions: 24.0 m diameter, 452.4 m<sup>2</sup> unit area, 3.40 m depth, 1,357.2 m<sup>2</sup> total area and 4,614.37 m<sup>3</sup> total

<sup>19</sup> COD is the acronym for Chemical Oxygen Demand.

<sup>20</sup> BOD<sub>5</sub> is the acronym for Biological Oxygen Demand, and it is the amount of dissolved oxygen consumed in five days by biological processes breaking down organic matter

<sup>21</sup> TSS is the acronym for Total Suspended Solids.

volume, with a retention time of about 4 hours. Primary sedimentation has removal efficiencies of 20% BOD<sub>5</sub>, 35% COD and 50% SS. A blade at the bottom is useful for sludge discharge and other blade at the surface useful for floating solids removal.

Activated sludge process is a biological treatment limited to the carbon removal and partial nitrification of ammoniacal nitrogen and it is carry out in three parallel lines equipped with an oxygenation system through injection of fine air bubbles. Basins are of dimensions 10 m width, 30 m length and 4.0 m depth. Total volume is 3,600.0 m<sup>3</sup>. The average treatment capacity of each basin is 690.77 m<sup>3</sup>/h.

The efficiency removal of this treatment is about 75.8% for COD, 88.9% for BOD<sub>5</sub>, 81.1% for TSS, 60.6% for NH<sub>4</sub><sup>+</sup> and 51.2% P<sub>tot</sub>. Those results show good removal efficiencies and good degradation levels.

Final sedimentation and sludge recirculation include also three parallel lines and circular basins with upward and radial flow. This section is equipped with a system for quick removal of sludge and a superficial blade for foams and floating material removal.

Basins of final sedimentation have the following dimensions: 26 m diameter, 530.93 m<sup>2</sup> superficial area, 2.75 m depth, and 4,380.2 m<sup>3</sup> of total volume. The recycling of sludge from secondary sedimentation to biologic treatment is carrying out through to two different pumping stations. The first station is equipped with three feed screws, while, the second station is equipped with two submersible centrifugal pumps. Both screws and centrifuge pumps have a unit flow of 350.00 m<sup>3</sup>/h.

Effluent disinfection is carried out by chlorination using Sodium hypochlorite - NaOCl. Disinfection is connecting to the basin of sedimentation effluents through fiber-cement pipes of 0.5 m diameter. The disinfection basin is a rectangular basin with paths of dimensions 2.40 m internal useful width of contact canal, 85.0 m internal useful length of contact canal and 2.0 m depth, 408.0 m<sup>3</sup> total volume.

Effluents are discharged in the "Rio Gazzo" waterway.

### *Sludge treatment*

Sludge treatment is composed by:

A section of lifting of the excess biologic matter is equipped with two submersible centrifugal pumps, each pump has a flow of 35.0 m<sup>3</sup>/h. Hydraulic circuits permit throw again the sludge to the primary sedimentation or directly to the pre-thickening zone. Similarly, the section of lifting mixed sludge is composed by two electrical pumps installed near to the second basin of primary sedimentation.

The section of pre-thickening and lifting sludge to anaerobic digestion is constituted by one circular basin equipped by a scraper mechanized with central control. Thickened



sludge has sent to the anaerobic digestion through two progressive rotary pumps. Basin is of dimensions 12.0 m diameter, 113.1 m<sup>2</sup> surface area and 3.75 m depth.

Anaerobic digestion of the sludge is a two-stage mesophilic process (33 - 35°C). 1st stage reactor is heating through by heat exchanger system, and 2nd stage reactor is not heating but the process is completed here. Thermal power station (for sludge heating) is equipped with a boiler fed with gas from digestion process or eventually with gasoil. Digesters have follow dimensions: 1st stage reactor is 16.3 m diameter, 208.7 m<sup>2</sup> surface area, 8.6 m depth; while 2nd stage reactor is 10.2 m diameter, 84.7 m<sup>2</sup> surface area and 6.1 m depth.

Biogas from sludge digestion is accumulated in a wet gasometer and the excess are combusted in an automatic pilot flame torch. Gasometer has 7.6 m diameter and 4.0 m depth.

Mechanical dehydration of sludge includes two belt-press units; one of them is currently substituting by a high efficiency centrifuge (it can reach about 25% of dehydration efficiency and less volume for disposal). Discharge of sludge is carried out through a screw of 0.24 m diameter and 6.0 - 8.0 m<sup>3</sup>/h flow rate, while screw of sludge transportation has 30° slope.

Dehydrated sludge is stored in cylindrical containers in a canopy but it presents problems related odours.

### *Effluent treatment for industrial reuse.*

Finally, the plant also treats the effluents for final industrial applications. The section of plant is composed by follow stages:

Pumping and lifting effluents from chlorination section to clariflocculation sector is carry out through centrifugal pumps. There are 3 submerged centrifugal pumps with 240.0 m<sup>3</sup>/h of flow capacity. Pumps operation is correlate to water demand for industrial uses. The effluent is send to clariflocculation through one PE-pipe (Polyethylene pipe) of 0.35 mm diameter and with non-return valves making easier the operating and maintenance.

Clariflocculation section with sludge bed and recycling system is carried out adding with Ferric Chloride (FeCl<sub>3</sub>), Sodium hydroxide (NaOH) and auxiliary polymers mainly anionic polyelectrolyte (PONILIT GT-2). The process includes 4 phases: mixing of effluent with Ferric Chloride and sludge recirculation; flocculation; separating liquid and solid phases by sedimentation process; and thickening of sludge. For the storage of FeCl<sub>3</sub> and NaOH, there are two cylindrical and vertical tanks. The capacity of each tank is 10.0 m<sup>3</sup>. Reactives are introduced in the effluent in proportions of 0.04 m<sup>3</sup>/h of Ferric Chloride and 0.02 m<sup>3</sup>/h of Sodium hydroxide, regulated by two proportioning pumps. The basin used for mixing the effluent with reactive has 38.1 m<sup>3</sup> volume. Additionally, two basins for recycled sludge with capacity 6.0 - 30.0 m<sup>3</sup>/h.

Removal of residual suspended solids is made by filtration including two rotary disks with fabric filter support and automatic cleaning system. The effluent in the output of this section has a suspended solid final concentration lower of 10.0 mg/l, the efficiency is compatible with demand of water by industrial reuse and, also, ensure correct functioning of next section: disinfection by UV. The efficiency is 95%.

Disinfection is carrying out using ultraviolet radiation. The disinfection treatment presents maximum radiation of 50 – 80 mWs/cm<sup>2</sup>. The system is computerized. Treatment capacity is 360.0 m<sup>3</sup> with dimensions: 6.0 m width, 15.0 m length and 4.0 m depth.

Demineralization process is carrying out using ion exchange resins (two-stages: cationic and anionic) in order to reduce the level of sulfates (200.0 mgSO<sub>4</sub>/l) and chlorines (100.0 mgCl/l), effluent storage and recovery stations for internal and external uses. This section, also, is composed by activated carbon treatment filtration systems, the goal is reducing organic load in order to increase the ion exchange capacity. Chemical products used in this section are hydrochloric acid-HCl (cationic-strong) and sodium hydroxide-NaOH (anionic-weak). Then, the water is stored and sent to the principal discharge system of the plant. The effluent have optimal characteristic by industrial use.

Finally, chemical sludge is transported in the basin for a mechanical thickening and mechanical dehydration. Basin has dimensions 5.0 m diameter, 19.6 m<sup>2</sup> total area, 3.0 m depth and 58.9 m<sup>3</sup> of volume. Final sludge is discharge through internal pipes.

## **2.2. Case study 2: South America**

### **2.2.1. Bucaramanga, Colombia**

Bucaramanga is the capital city of the Santander's department. Bucaramanga is located on a plateau in the Eastern Colombian Andes. The official metropolitan area includes the municipalities of: Girón, Piedecuesta and Floridablanca. It is located about 600 a.m.s.l. Even so, its climate is warm with an annual average of 22°C ranged between 16°C in winter and 30°C in summer. Total annual precipitation is about 1,280 mm.

The population is about 523,040 inhabitants. It is the fifth largest city economy and sixth on population in Colombia. The city is the base of the Colombian Petroleum Institute (ICP), the research branch of the state oil company Ecopetrol and the Colombian Natural Gas Company (Ecogas).

There is a hydric pollution in the rivers of Bucaramanga because most of them are receptor bodies of effluents from wastewater treatment plants. During the last year, the government installed 61 monitoring points in the area of these rivers.

Bucaramanga has the first UASB pilot plant built in the world and the first UASB full scale plant, La Rosita and Río Frío WWTP respectively. Many points of La Rosita have been studied for design and construction of Río Frío WWTP. Technical and economic feasibility in tropical weather has been demonstrated with Río Frío WWTP operation.



Figure 2.4: Location of Bucaramanga in South America. Source: [Google maps].

### *Río Frío WWTP*

The start-up process of Río Frío WWTP was started at November 1990 with one reactor. The process was so slow, during the first six months the process was equivalent at primary sedimentation used as sludge storage. After that, the reactor was functioning satisfactorily, under hydraulic conditions planned in design. The second reactor began its function in January 1991. From May 1991, the company developed a scheme for operation alternate of reactors and to increase loads gradually. A third reactor began its operating in 1994 and a fourth reactor in 2005. Each reactor had a 3,360 m<sup>3</sup> of volume. There are two facultative ponds of 27,000 m<sup>2</sup>. total area as post-treatment. Table 2.1 shows the design parameters for this plant:

Table 2.1: Design parameters for UASB reactors of Río Frío WWTP

<i>Year</i>	<i># Inhabitants</i>	<i>Flow (m<sup>3</sup>/h)</i>	<i>Organic load (kg DBO/d)</i>	<i># UASB Reactors</i>
1991	153,000	1,339.2	4,590	2
1993	180,000	1,451.8	5,400	3
1998	220,000	2,009.3	6,600	3
2003	280,000	2,451.6	8,400	4
2008	340,000	2,973.6	10,200	5

Source: [Montalvo, 2003]

The first measured efficiencies were about 60 - 65% for COD, 72-76% for BOD<sub>5</sub>, and, 67 - 70% for TSS; with 5h of HRT (Hydraulic Retention time). While, final effluent had a BOD<sub>5</sub> about 20 g/m<sup>3</sup>. The initial investment for UASB reactors was US\$ 1'235,980.

Problems in the system were: biogas leaks on the tri-phase separator system (gas-solid-liquid), and biogas leaks in the union of prefabricated elements. These problems caused damage in the water quality and generated unpleasant odours. Problems are solved gradually with the same sludge and solids that there are into the reactor. Currently, 4 reactors are operating and two facultative ponds. Nowadays, one of the ponds is being replaced with an aerated tank, as was anticipated in a Modernization Plan, where secondary treatment includes aerobic-anoxic treatment [Uribe, 2009]. The total capacity of the plant is 2,520 m<sup>3</sup>/h. The WWTP is under management of EMPAS<sup>22</sup> S.A. ESP<sup>23</sup> and CDMB<sup>24</sup> who is the proprietary of operation license. A satellite view of the plant is shown in figure 2.5.



Figure 2.5: Satellite view of Río Frío WWTP in 2010. Source: [Google earth].

The current process is composed by preliminary treatment, primary treatment and secondary treatment.

*Preliminary treatment* is constituted by a by-pass in the entrance with a structure used as excess dump, with a Venturi pipe for measuring the flow. One automatic coarse screen and one mechanical fine-screen made by galvanized stainless steel. Then, three basins of grit removal with dimensions of 26.6 m length, 2.5 m width, and 1.05 m useful depth were implemented. UASB reactors constitute the *primary treatment*. Each reactor has 18 modules [Alcaldía de Bucaramanga, 2009]. Characteristics of reactors are shown in the table 2.2:

---

<sup>22</sup> EMPAS is the Spanish acronym for Empresa pública de Alcantarillado de Santander.

<sup>23</sup> S.A. ESP is the Spanish acronym for Sociedad Anónima and Empresa de servicios públicos

<sup>24</sup> CDMB is the Spanish acronym for Corporación Autónoma Regional para la Defensa de la Meseta de Bucaramanga.

Table 2.2: UASB reactors characteristics of Río Frío WWTP

Parameter	Value
Useful depth	4.0 m
Average HRT	5 h
Inclination angle of tri-phase separator	52°26'
Sludge bed depth	1.4 m
Modules by reactor	18 modules
Dimensions of each unit module	4.8 m x 2.4 m
Total reactor width	19.20 m
Total reactor length	43.20 m
Total reactor depth	4.6 m
Useful reactor volume	3,335 m <sup>3</sup>

Source: [Montalvo, 2003].

Secondary treatment consists to lead the effluent from UASB reactors to facultative ponds. The dimensions of ponds are 200 m length, 100 m width and 1.5 m depth. The permeability of bottom and slopes (sides) are made with compacted clay [Gobierno de Colombia, 2009]. Effluents are discharged in the Río Frío stream.

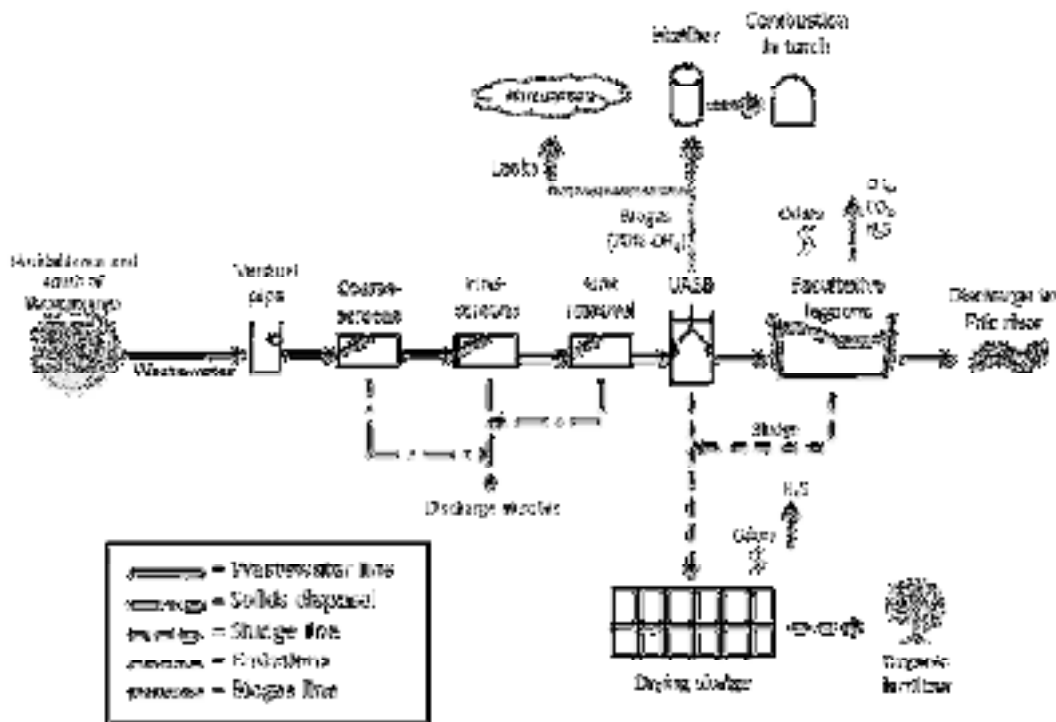

Figure 2.6: Río Frío's wastewater treatment system.

Solids and wastes from screening are stored temporarily in closed containers and get a final disposal in the El Carrasco's landfill. Sands retained in grit removal process are collected by trucks and transported to southwest extreme of the WWTP, where are used as fill material for embankment in the neighboring areas to the receptor stream. Sludge from UASB reactors is removed weekly and discharge in 48 sludge drying beds which take up

7,500 m<sup>2</sup> of area [Alcaldía de Bucaramanga, 2009]. When sludge is removed from drying beds they are undergone composting process for final applications as organic fertilizer in CDMB reforestation programs [Alcaldía de Bucaramanga, 2009]. Finally, 6 gas holders have been installed for biogas combustion.

**Modernization plan**

A modernization plan is designed since many years ago. This project would be permit the valuation and control of biogas emissions, and improve the effluent quality, applying the regulations of CDM<sup>25</sup>. The treatment capacity would be increasing from 2,520 m<sup>3</sup>/h to 7,200 m<sup>3</sup>/h. Due to the high methane content in the biogas, electricity generation is planning. Moreover, replacing facultative ponds by aerobic-anoxic treatment with four aeration tanks and four settlers is also planning.

Reduction of greenhouses emissions (CH<sub>4</sub> and N<sub>2</sub>O) and CERs (Certified emission reductions) are the main goal. The project began its construction in 2007. It is planned to finish first phase for final 2013. A scheme of modernization plant was shown in figure 2.7.

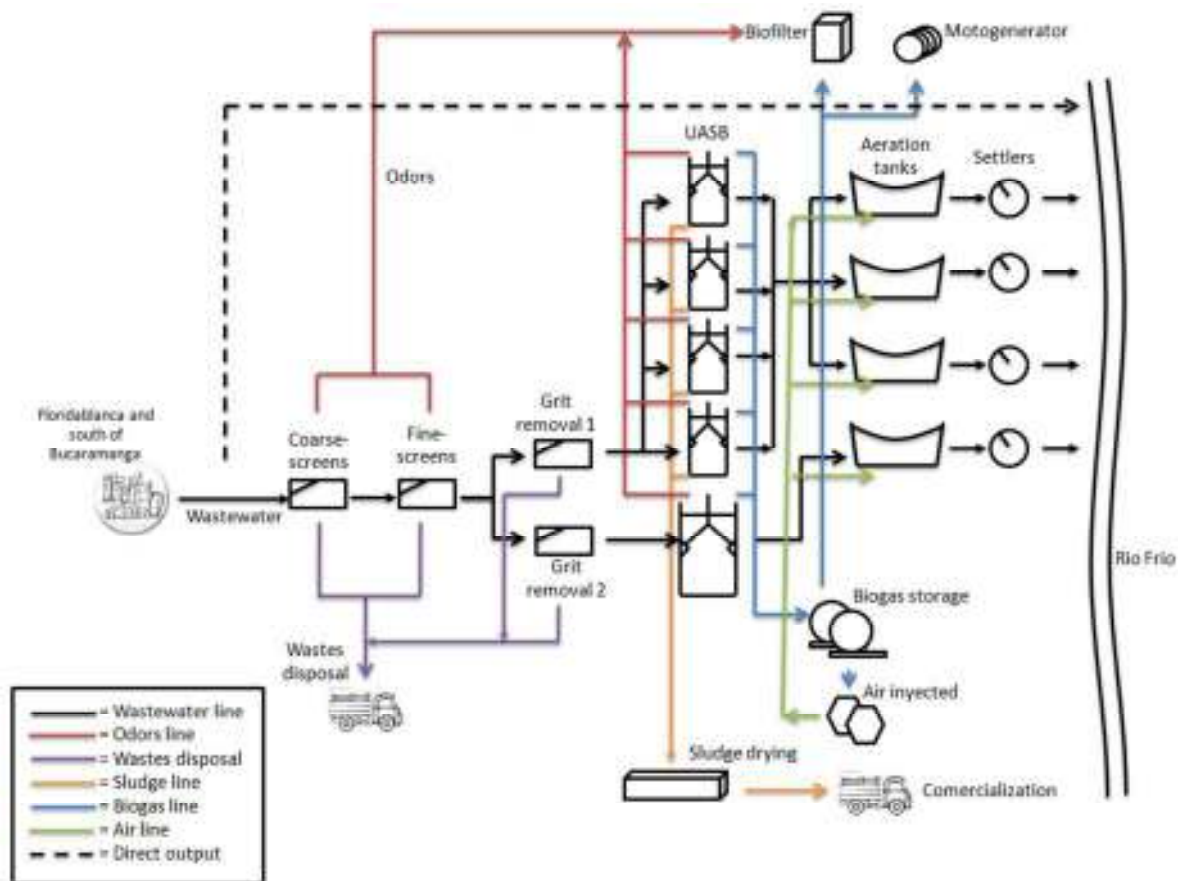

Figure 2.7: Modernization plan proposed for Río Frío WWT.

<sup>25</sup> CDM is the acronym for Clean Development Mechanism.

## 2.2.2. Chiclayo, Peru

Province of Chiclayo is the capital of Lambayeque region. It is located at northwest of Peru's coast area, in South America central western region. It is located to 24 a.m.s.l, 770 km. to the north of Lima, the capital of Peru; 578 km. to the south of Ecuador's border, and 12 km. to the Pacific Ocean.



Figure 2.8: Location of Chiclayo in South America.  
Source: [Google Maps].

The population is about 574,400 inhabitants in the Chiclayo's city area according to Census 2007 of INEI<sup>26</sup>, the climate is temperate - warm during autumn, winter and spring and hot during summer. The annual average temperature is 18,2°C; maximum temperature is 31°C in summer and minimum 15,4°C in winter, with shortage of rain during all the year. the ENSO (El Niño-Southern Oscillation) phenomenon called also "El Niño" can vary temperatures between 20°C in winter and 34°C in summer. The principal sources of water are Chancay -Lambayeque basin and Chotano sub-basin.

The EPSEL<sup>27</sup> S.A. manages storage, distribution and treatment of the water. For the treatment of wastewater in Chiclayo's city, two treatment plants have been implemented: Pampa de Perros and San José stabilisation ponds. Pampa de Perros treats the water of north pipes and San José treats water of north, south and north-south pipes [Agenda Local 21, 2006] (See figure 2.9).

<sup>26</sup> INEI is the Spanish acronym for Instituto Nacional de Estadística e Informática.

<sup>27</sup> EPSEL is the Spanish acronym for Empresa Prestadora de Servicios de Saneamiento de Lambayeque.

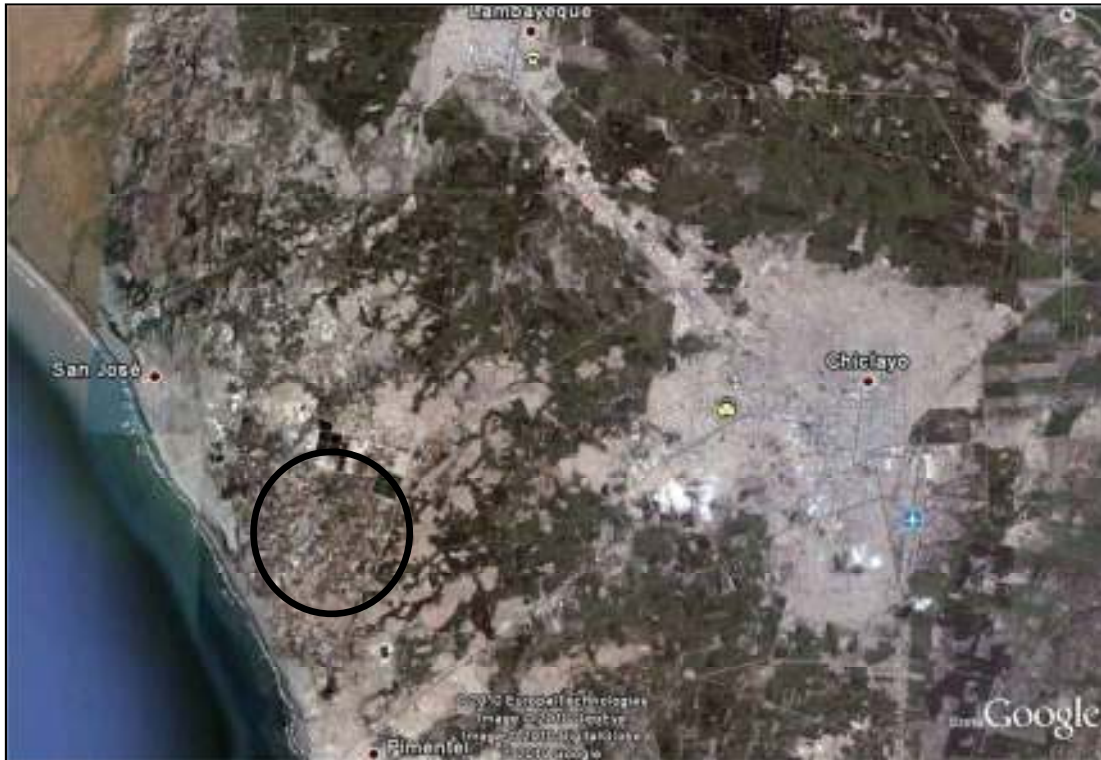

Figure 2.9: Satellite view of Chiclayo's wastewater treatment plants: San José and Pampa de Perros. Source: [Google earth].

The service of wastewater treatment (including domestic, industrial and commercial sewage) have three stages: conduction, treatment and final disposal. For the conduction and collection the sewage, EPSEL S.A. has installed about 915.07 km. of sewage pipes, but a great part is in poor condition due to their age-old and/or lack of maintenance and renewal works.

Conduction and treatment of wastewater have serious problems: collectors have more than 40 years old; effluents are mixed in the same collector; industrial sewage has no a pre-treatment before municipal pipes; there is no a drainage system for rain water and for example, during El Niño, pipes are saturated and collapse within hours; the system only supply urban areas; Chiclayo's population have no an environmental educations and is insensitive to use sanitation services; finally, the current wastewater treatment generates a big quantity of greenhouses and odours affecting the environment and the health of human settlements near to the plant.

Treatment capacity of San José wastewater plant is about 2,853 m<sup>3</sup>/h. The plant has 5 anaerobic ponds and 5 aerobic ponds; and, treatment capacity of Pampa de Perros is about 708 m<sup>3</sup>/h. This plant has 4 anaerobic ponds and 4 facultative ponds. Both are located in San José district distanced 1.00 km between them. The San José treatment process is shown in figure 2.10. and has been studied in the present work.



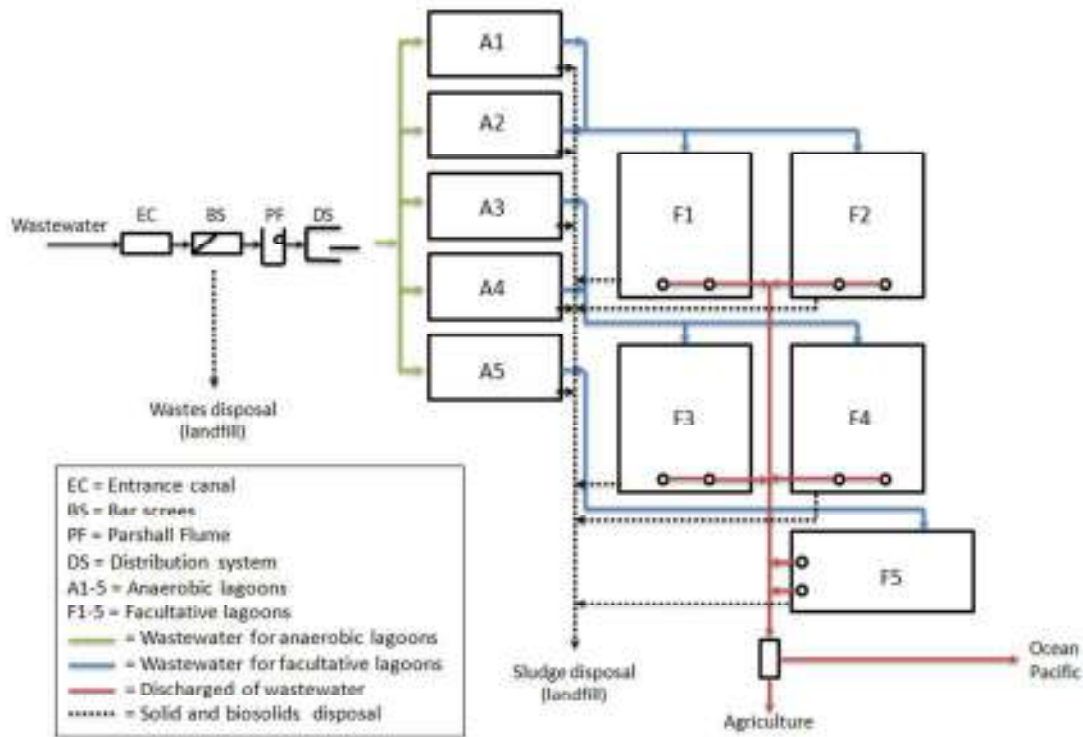

Figure 2.10: Wastewater treatment system of San José WWTP. Source: [EPSEL, 2008]

In the San José plant, wastewater of Chiclayo is collected and transported by gravity to the *principal Entrance Canal*, it has a rectangular section and adequate slope for a maximum flow rate circulation of 5,760 m<sup>3</sup>/h. Preliminary treatment is composed by two parallel units of *Coarse screens* with two automatic electromagnetic units. Then, a *Parshall flume* measures the flow rate. After that, *distribution system* leads the flow to the anaerobic ponds. The organic matter is stabilized in the *anaerobic ponds* and settleable sludge is accumulating at the bottom. The process generates CH<sub>4</sub>, CO<sub>2</sub> and H<sub>2</sub>S mainly, an unpleasant odour is characteristic in this stage. *Facultative ponds* complete the treatment through oxygenation due to the presence of algae. Water is green and without characteristic odour. An *Exit Canal* with a by-pass permits the control of the effluents through two metal gates that permit water distribution for final discharge in the sea (San José and Santa Rosa beaches) and farmer's *irrigations canal*.

Effluents are adequate by high-stalk crops irrigations, because the system has efficiencies about 71.4% for BOD<sub>5</sub> and 90.5% for Faecal Coliform [Epsel 2010]. Initial concentrations are about 227 mgBOD<sub>5</sub>/l and 4.11E+07 MPN/100 ml of Faecal Coliform. Final effluent has about 65 mg BOD<sub>5</sub>/l and 3.9E+06 MPN/100 ml concentrations.

However, the scarcity of water for irrigation in the area, lack of sanitation culture and ineffective control by authorities are favourable to illegal irrigations of short-stalk crops. On the other hand, the pollution in the beaches is increasing due to the discharges.

Researchers in Peru have demonstrated that effluents from stabilisation ponds are adequate for non-potable uses and landscape reclamation. But, wastewater management

must be involves the environmental education, establishing clear policies of sewage treatment and investments on research.

### **2.3. Comparisons of cases study.**

Differences between industrialized countries and developing countries are notable. At the same time, differences among developing countries can also remarkable.

While in industrialized countries is possible applied high-cost technologies with qualified human resources, sanitary education and payment capacity of costs; in developing countries, wastewater are discharged in water bodies, many cities have a simple and basic treatment system, and other simply do not have any kind of treatment.

#### *Chiclayo - Bucaramanga*

The goal of wastewater treatments in developing countries is reducing BOD<sub>5</sub>, suspended solids, and pathogenic removal. But for use and reuse of wastewater requires the elimination of other toxic material and many applications required advanced treatments.

The environment of Chiclayo's city has undergone a gradual process of deterioration generating negative impacts and affecting the natural state of urban environment, the life quality of the population and the economic situation. Many communities are being affected by disposal of raw wastewater or wastewater treated, greenhouses emissions and destruction of aquatic environment.

As consequence of inefficient and/or nonexistent sewage service there is a high level of diarrheal diseases, especially in children under five years and population of poor urban areas. The risks are higher due to the illegal irrigation of short-stalk crops with wastewaters.

The differences are basically the technology. Regarding Chiclayo's treatment plant, natural processes play an important role in decomposition of organic components, but it does not pay attention on the impacts on the environment and human health. On the other hand, anaerobic digestion of organic components has more advantages, mainly, allowing the use of products as energetic resources.

Stabilisation ponds are a popular treatment system due to low-cost of investment (except by the land), operation and minimal maintenance; also, they have a high potential for assimilate organic and hydraulic fluctuating loads. Their properties of to be aerobic at the surface and anaerobic at the bottom permit the treatment and stabilization of soluble organic wastes being adequate for treat domestic and industrial wastewater. The main advantage of the system is its effectiveness for reduced pathogens.

UASB represents a simple, compact and low-cost process constituting an interesting alternative for wastewater treatment particularly in developing countries. It is achieved BOD<sub>5</sub> removal more than 65%, but due to short HRT, pathogens are only partially removed, then, a post-treatment is necessary, stabilization ponds are an optimal post-treatment for effluents from UASB reactors in developing countries, especially where stabilisation ponds are already operating as done in Rio Frio treatment plant. Also, this system permits reduce the area affected by odours. Both, biogas and sludge represent great energy sources.

Table 2.3 illustrates main differences between Chiclayo and Bucaramanga treatment systems:

Table 2.3: Technological differences between Chiclayo and Bucaramanga wastewater treatment plants.

<i>Type of treatment</i>	<i>Chiclayo, Peru</i>	<i>Bucaramanga, Colombia</i>
Preliminary treatment	Coarse screens	Coarse screens
	Parshall flume	Fine screens
	Distribution system	Grit removal
Primary treatment	Anaerobic ponds	UASB reactors
Secondary treatment	Facultative ponds	Facultative ponds
Reuse of wastewater	Agriculture	Agriculture and landscape
Final disposal	Discharge on the sea	Discharge on Río Frío stream
Treatment of solids and biosolids	No treatment of solids	Sludge bed drying
Final disposal of solids and biosolids	Disposed in landfill or open areas	Landfill, Organic fertililzer
Treatment of gases	No treatment of gases	Biofilter, storage and combustion

### *Chiclayo - Novi Ligure*

In developed countries, the goal of wastewater treatment is organic matter and nutrients removal [Van Haandel et al, 1994]. In Novi Ligure and other developed country cases, the technology is applied also for treating residues of the process and getting benefits for the population and the environment where the sewage is discharge.

Table 2.4 illustrates the main differences between Chiclayo and Novi Ligure treatment plants.

Table 2.4: Technological differences between Chiclayo and Novi Ligure wastewater treatment plants.

<i>Type of treatment</i>	<i>Chiclayo, Peru</i>	<i>Novi Ligure, Italia</i>
Preliminary treatment	Coarse screens	Coarse screens
	Parshall flume	Fine screens
Primary treatment	Distribution system	Grit Removal
	Anaerobic ponds	Primary sedimentation
Secondary treatment	Facultative ponds	Activated sludge
		Secondary sedimentation
Tertiary treatment	No tertiary treatment	Disinfection by chlorination
Reuse of wastewater	Agriculture	Treatment for industrial reuse
Final disposal of wastewater	Discharge on the sea	Industrial applications
		Discharge to "Rio Gazzo" river.
Treatment of solids and biosolids	No treatment of solids	Anaerobic digestion
		Sludge drying
Final disposal of solids and biosolids	Disposed in landfill or open areas	Agriculture and other applications (gasification researches)
		Biofilter, storage and combustion
Treatment of gases	No treatment of gases	

## 2.4. Discussion.

Economic and cultural environments of many developing countries is a barrier for achieve basic goals of wastewater treatment. The lack of support and investment of local and regional governments are important details in the Peruvian context. Often, wastewater treatment plants do not have adequate instruments and equipments for an efficient work; for example, about the analysis of wastewater characteristics and pollutants removal. Moreover, there are political and management problems for the access to the information.

An important factor to keep in consideration is the main purpose of the technologies applied. While ponds are designed for a reduction of Faecal Coliforms levels and the effluents are adequate for high-stalk crops irrigation; conventional processes as activated sludge, biofilters and anaerobic reactors are designed for reduction of BOD<sub>5</sub> and COD concentration levels, in this way, the effluents are adequate for non-potable applications or discharge in the environment without negative impacts. The application of processes with technological alternatives is slow in developing countries mainly due to:

- There are not regulations for controlling and prevention of water pollution.
- There is quite diffusion of advantages using anaerobic processes.
- Low interesting by using technological alternatives due to the international influence about conventional processes applications.

The implementation of sustainable technologies has the objective of promoting the protection of public health, the environment and reuse of wastes.

Successful experiences from other countries must be taken in consideration for application in developing regions. The know-how of Novi Ligure is useful and means the bases for the adaptation of Chiclayo treatment plant which will be discussed in the following chapter. Rio Frio treatment plant is an example of treatment and management of sewage with anaerobic technology and adequate stabilisation ponds. Both examples studied will be beneficial for the follow research because include components which will be taken into account due to the necessity of a strong modification of the Chiclayo's process flow sheet.

Other diverse kind of treatment technologies from characteristics of the domestic sewage to tertiary kind of treatment are described in annex 1.

## **CHAPTER 3: WASTEWATER TREATMENT: LARGE-SCALE PLANT PLANNING**

Considering previous description of current wastewater treatment plant, and on the basis of the Italian and Colombian experiences, a development of a proposal for the adaptation of the Chiclayo city (Peru) wastewater treatment plant was done with the goal of verification and adaptation of the existing structures, equipment and sections, considering the current potential of the water flow sheet and the perspectives of valorization of wastes.

Current process consists of preliminary treatment for the removal of coarse materials, followed by stabilisation (anaerobic and facultative) ponds and discharges into the sea or agricultural lands, solids are disposed in controlled landfills. Nevertheless, the current structure of the plant requires a general and overall inspection considering the nominal flow rate and pollutants, providing the medium - long term and agreement with the regional regulations.

In this chapter it will be discuss the providing the measures of implementation for:

- Adaptation of preliminary treatment including fine screens.
- Implementation of grit removal section.
- Verifying of Parshall flume section.
- Implementation of anaerobic digestion section with UASB reactors instead of anaerobic ponds
- Verifying dimensions and operation characteristics of facultative ponds.
- Implementation of sludge and biogas recuperation systems.
- Preliminary studies about environmental impact assessment and economic feasibility.

### **3.1. Project data**

As the first step, it is important determining the project data in order to verify the wastewater characteristics and current operating conditions.

#### **3.1.1. Population**

EPSEL S.A. is the company who operates and manages the drinking water and sewage for Lambayeque Region; politically divided in three provinces - Lambayeque, Chiclayo and Ferreñafe. Chiclayo province has 20 districts and an estimate of 729,433 inhabitants. According to the last Census of Population and Housing, there are about 574,408 inhabitants in the Chiclayo's city area, which is limited by 6 municipalities [RENIEC<sup>28</sup>, 2010].

---

<sup>28</sup> RENIEC is the Spanish acronym for "Registro Nacional de identificación y estado civil".

As mentioned in the previous chapter, two wastewater treatment plants treat sewage from 3 municipalities (La Victoria, Chiclayo and José Leonardo Ortiz), they are Pampa de Perros and San José, located far 6 km of Chiclayo district. This work is emphasizes in the San José wastewater treatment plant (WWTP), San José WWTP serves, according to EPSEL S.A., a population about 332,000 inhabitants from La Victoria and Chiclayo district. There are other plants which treat the sewage from the other 3 municipalities.

### 3.1.2. Flow rate: domestic and improper water: rain water

The information about wastewater flow rate is since 2007 to 2011 years, even it is not complete for every month. San José treats about 2,853.03 m<sup>3</sup>/h, while Pampa de Perros treats about 720.00 m<sup>3</sup>/h. The values of average monthly, particularly the average of maximum flow rates registered in the peak hours are considered.

The drinking water of Chiclayo city is treated by two plants: N.1 and N.2, the flow rate pumping to the city area in peak hours is 4,500 m<sup>3</sup>/h approximately. Afterwards, wastewater is collected through the sewage system. Three principal sewage pipes collect the water from the 3 districts before mentioned: South pipe collects wastewater from La Victoria district; North pipe, from Chiclayo district; and North-north pipe, from José Leonardo Ortiz district.

Table 3.1 shows the daily average flow rate measured between 2007 and 2010. The media of minimum daily flow rate is 1,516.60 m<sup>3</sup>/h, and the media of maximum daily flow rate is 3,026.22 m<sup>3</sup>/h. Then, 2,853.03 m<sup>3</sup>/h as design flow rate was considered.

Table 3.1: Flow rates since 2007 to 2010.

Month	Daily flow rate (m <sup>3</sup> /h)		
	Minimum	Average	Maximum
January	1,584.72	2,198.16	2,811.60
February	1,584.72	2,382.48	3,180.24
March	947.88	1,835.28	2,722.32
April	1,658.52	2,190.60	2,722.32
May	1,733.40	2,228.04	2,722.32
June	1,733.40	2,457.00	3,180.24
July	1,658.52	2,145.24	2,631.60
August	1,658.52	2,146.32	2,633.76
September	1,302.12	2,079.72	2,856.96
October	1,483.92	2,065.32	2,711.52
November	1,268.28	2,107.80	2,948.04
December	1,584.72	2,382.48	3,180.24

Source: [EPSEL S.A. 2007]

On the other hand, Chiclayo has a warm and dry weather and sun shining during all the year. There are very low precipitations between months December and April, they do not exceed 250 mm per year. The ENSO phenomenon occurs each 3 or 11 years, with 240 mm of precipitation in 1983 and 402 mm in 1998 during the last 50 years. Thus,

precipitations do not supposed significant flow rate increases and it is not seriously affected. Table 3.2 compares the flow rates and total precipitation; while table 3.3 shows the precipitations for the last 30 years.

Table 3.2: Average flow rates and total precipitation.

Month	Average flow rate	Maximum flow rate	Total precipitation
	$m^3/h$	$m^3/h$	Mm
January	2,198.16	2,811.60	4.07
February	2,382.48	3,180.24	97.30
March	1,835.28	2,722.32	3.81
April	2,190.60	2,722.32	1.78
May	2,228.04	2,722.32	2.03
June	2,457.00	3,180.24	0.00
July	2,145.24	2,631.60	0.00
August	2,146.32	2,633.76	0.00
September	2,079.72	2,856.96	0.00
October	2,065.32	2,711.52	12.70
November	2,107.80	2,948.04	0.00
December	2,382.48	3,180.24	1.02

Source: [EPSEL S.A. 2010 and Online, 2011]

Table 3.3: Total precipitation levels in the last 30 years.

Month	Monthly precipitation by year (mm)						
	1979	1983	1987	1993	1998	2003	2010
January	2.04	118.11	0.00	1.02	71.88	0.00	0.00
February	119.89	2.04	4.06	0.76	200.66	10.67	30.98
March	2.03	86.30	0.00	22.10	147.04	0.00	1.02
April	0.00	88.91	0.50	4.07	30.23	0.00	0.76
May	4.06	14.99	0.00	0.00	1.02	0.00	1.02
June	0.00	8.38	0.00	0.00	0.00	0.00	0.00
July	0.00	0.00	0.00	0.00	0.00	0.00	0.00
August	0.00	0.00	0.00	0.00	0.00	0.00	0.00
September	0.00	0.00	1.02	0.00	1.02	0.00	0.00
October	7.87	0.00	0.00	0.00	1.02	0.00	60.96
November	0.00	2.03	0.00	0.00	0.00	5.08	4.07
December	0.00	0.00	0.00	0.00	5.08	4.06	0.00

Source [Tu tiempo network, 2011]

### 3.1.3. Organic load concentration: BOD<sub>5</sub>

Biological oxygen demand (BOD<sub>5</sub>) and Total suspended solids (TSS) are analyzing by EPSEL S.A. laboratories; the values are expressed in mg/l for BOD<sub>5</sub> and ml/l/h for SST.



Table 3.4 shows summarized BOD<sub>5</sub> values measured since 2007 to 2010. Values of 2011 have not been registered, yet.

Table 3.4: BOD<sub>5</sub> Historical dates since 2007 to 2010

Month	BOD <sub>5</sub> (mg/l)			
	2007	2008	2009	2010
January	141.56	242.55	235.20	172.80
February	143.55	170.78	179.30	228.13
March	188.10	178.63	201.60	227.30
April	200.67	250.60	213.60	252.45
May	198.00	250.60	225.60	224.73
June	198.28	253.23	185.00	212.17
July	156.75	225.29	170.00	259.70
August	168.30	225.29	207.82	200.49
September	221.45	221.50	165.00	202.65
October	240.10	228.00	223.20	230.43
November	215.35	222.40	264.50	234.08
December	240.07	250.60	172.80	221.16

Source: [Epsel 2010]

It is important to note that sampling of wastewater from ponds is done twice or three times by month. Data were considered only those exceeding 200 mg/l. In this sense, the average BOD<sub>5</sub> of raw wastewater is about 227.01 mg/l.

### 3.1.4. Organic load concentration: COD

Chemical oxygen demand (COD) value is an unknown parameter. According to the literature, it is possible to find a ratio between BOD<sub>5</sub> and COD. In Ahwaz (India) wastewater treatment plant, there is a full scale Up-flow anaerobic sludge bed (UASB) reactor, where the influent has a ratio varying between 1.7 and 2.0. Rio Frio (Colombia) has a ratio about 1.5 and 1.6. Theoretically, a ratio between 0.5 - 2.0 should be acceptable. For Chiclayo's case, 1.5 was assumed, thus, COD concentration is about 340.52 mg/l.

### 3.1.5. TSS and Faecal Coliform concentration

An Imhoff cone is used to measure TSS concentration in a time of 60 min. The measure is expressed in ml/l, which means the volume of solid settled in one hour, and it is useful to know the amount of solids will be get. It is a parameter valid for stabilisations ponds design. According to table 3.5 an average of total suspended solids is about 2.67 ml/l, and a typical concentration is about 140 - 250 mg/l, while Faecal Coliform average concentration is about 4.11E+07 MPN/100ml.

Table 3.5: TSS present in wastewater of Chiclayo city.

<i>Month</i>	<i>TSS (ml/l)</i>			
	2007	2008	2009	2010
January	2.63	2.50	4.00	1.00
February	2.40	1.35	1.95	4.05
March	1.77	1.67	3.25	3.00
April	1.75	3.53	2.68	1.75
May	1.40	3.53	2.47	2.80
June	1.97	2.75	4.25	3.20
July	2.03	3.10	0.75	4.05
August	2.10	8.02	3.05	4.39
September	2.15	3.25	3.05	2.82
October	1.35	3.10	3.50	2.65
November	2.35	6.00	2.25	3.53
December	4.45	3.53	1.00	2.73

Source: [EPSEL S.A. 2010]

### 3.1.6. pH

The pH value and its stability in an anaerobic reactor is very important because methanogenesis phase only proceeds when the pH is maintained in the neutral range. Moreover the microorganisms are different in every phase of digestion. It is necessary keeping the equilibrium between acid production and methane production; thus, the diverse types of microorganisms can coexist into the reactor and created the conditions for their development. Optimal pH values have to be in the range 6.3 – 7.8. And, an adequate and stable pH can be maintained low nutrients and chemicals requirements. According to table 3.6, the pH values tested show that sewage is maintaining neutral and ideal to be treated in UASB reactors.

Table 3.6: Average pH values of wastewater from Chiclayo city in last 4 years.

<i>Months</i>	<i>Average Ph value</i>			
	2007	2008	2009	2010
January	7.18	7.92	7.69	7.63
February	7.62	7.45	7.72	7.54
March	7.51	7.68	7.65	7.93
April	7.32	7.05	7.50	7.83
May	7.32	7.50	7.73	7.84
June	7.43	7.52	7.83	7.49
July	7.60	7.52	7.53	7.49
August	7.47	7.54	7.84	7.50
September	7.58	7.87	7.93	7.62
October	7.77	7.62	7.63	7.67
November	7.41	7.28	7.69	7.46
December	7.55	7.98	7.63	7.72

Source: [EPSEL S.A., 2010]

### 3.1.7. Temperature and Hydraulic retention time (HRT)

Anaerobic digestion like other biological processes strongly depends on temperature. Two digestion phases depending on temperatures occur in a UASB reactor: mesophiles and thermophiles phases. The first one, mesophilic bacteria can live optimally between ranges 35 and 40°C. While Thermophilic bacteria can survive in range of 55 to 60°C. For domestic wastewater treatment, mesophilic digestion at controlled temperature is relevant and recommended [Van Haandel et al, 1994].

Applications of digestion process in a UASB reactor is more attractive for tropical (wastewater temperature above 20°C) and subtropical (temperature above 15°C) climate conditions [Van Haandel et al, 1994]. Chiclayo climate is classified as subtropical and arid climate. Several pilot and full-scale plants are operating in tropical and sub-tropical countries. Studies on those plants show that higher temperatures cause an increasing of the BOD<sub>5</sub> and COD removal efficiency. In Ahwaz WWTP (Iran), it was demonstrated for the same HRT, increasing sewage temperature from 21 to 24°C, BOD<sub>5</sub> and COD removal efficiency also increased from 53% to 75% and from 46% to 65% respectively [Azimi et al, 2004]. In Cali (Colombia) - the first UASB pilot scale plant - the climate is savanna tropical, keeping almost temperature during the year about 24°C, the reactor is operating to HRT's of 4 - 6 h and its giving satisfactory results. BOD<sub>5</sub> and COD removal efficiencies are in the ranges between 75 - 93% and 75 - 82% respectively.

The Rio Frío full-scale WWTP is, at present, operating with 5 reactor (3,400m<sup>3</sup> of capacity for each one). The range of operating temperature is between 24 and 35°C, while the HRT is about 5 hours. They can achieve 64 - 78% of BOD<sub>5</sub> removal efficiency and 45 - 60% of COD removal efficiency.

According to G. Lettinga, hydraulic retention time and temperatures have an strength relation [Lettinga et al, 1991]. Experiences with low temperatures (13 - 17°C) have been studied in Netherlands and other European countries since 1976. The obtained results reported operations with long HRT (14 - 17 h) with low BOD<sub>5</sub> or COD reductions (55 - 70%) [Van Haandel et al, 1991]. In cases when temperatures are lower than 10°C, HRTs were about 20 hours and BOD<sub>5</sub> removal efficiency were about 40 - 59% while COD removal efficiency were about 31 - 45%. Those researches demonstrated that optimal BOD<sub>5</sub> and COD removals can be achieved with HRT 6 to 8 hours and when reactors are applied for tropical climate conditions. The region where Chiclayo city is located presents hot summers (28 - 32°C) and moderate winters (15 - 20°C).

Table 3.7 shows the summary of data project.

Table 3.7: Project data for sizing of the San José wastewater treatment plant.

<i>Parameter</i>	<i>Measure unit</i>	<i>Year 2007 - 2010</i>
Total population	No. inhabitants	574,000.00
Population served	No. inhabitants	332,000.00
Maximum flow rate	m <sup>3</sup> /h	3,026.22
Design flow rate	m <sup>3</sup> /h	2,853.03
Minimum flow rate	m <sup>3</sup> /h	1,516.56
Average monthly precipitations	mm/Month	55.00
Precipitations in extraordinary period	mm/Month	250 - 402
Rainy season	Months	December - April
Total Organic load (BOD <sub>5</sub> )	kg/h	647.67
Average BOD <sub>5</sub> concentration	mg/l	227.01
Total COD load	kg/h	971.50
Average COD concentration	mg/l	340.52
Average TSS concentration	mg/l	250.00*
Faecal Coliform concentration	MPN/100ml	4.11E+07
pH	-	7.60
Temperature	°C	cold period: 14.5 - 20°C warm period: 28.0 - 32°C

\* It was assumed the maximum value permit by Peruvian laws.

Source: [EPSEL S.A, 2010; RENIEC, 2010, and Tu tiempo Network, 2011]

## 3.2. Description of the new treatment cycle proposal

The current water depuration cycle could be modified to include a biological treatment section, where UASB reactors instead of anaerobic ponds are considered to provide the ideal configuration.

### 3.2.1. Sewage treatment

- a) Main entrance channel: It is an open channel with a rectangular section and an adequate slope (0.002 m/m) which permit the pass of flow approximately 0.79 m<sup>3</sup>/s. Normally, water is dark-grey color; but when the flow rate is smaller than the nominal flow rate the water would become pinkish color, while, when the flow rate is greater, the water would become also pinkish color with white patches. The first one is due that the anaerobic conditions are not developing; the second one is due that a high BOD<sub>5</sub> concentrations is present.
- b) Coarse screen: There are two units of coarse screen placed in parallel at the main entrance channel. Those serve to remove large quantities of solids, bigger than 2.54 cm diameter (plastics bags, pieces of wood, sticks, straws, poultry feather, animal bodies and so on). The distance between bars is 6.35 cm and the size of the bars is 2.54 cm. Coarse screens units are automatically activated. Furthermore, two electromagnetic units have been installed for metal residues; four gates are located before and after of

each screen channel in order to controlled the flow rate for eventual cleaning and maintenance works.

- c) Fine screens: Preliminary treatment will be complemented by two fine screen units, they are essential for guaranteed a considerably reduction of quantity of solids and thus clogging must be avoid. They would be placed after the coarse screens units in the main entrance channel. The distance between bars is 12 mm and the size of the bars is 6 mm.
- d) Grit and oil removal: The last step of preliminary treatment is a grit removal basin. It will has a rectangular section and with a simple design, easy construction, low cost and small head losses, avoiding the pumping of sewage or air injections and thus minimum energy consumption is required. Solids and grits removed from preliminary treatment are disposed in a landfill in the vicinity of the plant.
- e) Parshall flume: A Parshall flume is already installed to measure the flow rate. The water level depth is measured and then it is correlated with the flow rate according to the follow table which has been developed for San José WWTP.

Table 3.8: Flow rates table used by EPSEL S.A.

<i>Depth (m)</i>	<i>Flow rate (m<sup>3</sup>/h)</i>
0.300	1,302.16
0.325	1,476.43
0.350	1,658.45
0.375	1,848.06
0.400	2,045.02
0.425	2,249.10
0.450	2,460.10
0.475	2,677.90
0.500	2,902.32
0.525	3,133.22
0.550	3,366.90
0.575	3,613.97
0.600	3,863.52

Source: [Epsel S.A. 2008]

- f) Influent distribution system: The influent is introduced into the reactors through an adequate distribution system with several points placed at the bottom. It is essential to keep a good contact between the water and the sludge blanket (biomass and substrate) [De Lemos, 2007] and to avoid formation of dead zones, especially when the water is of low-concentration, otherwise, if the mixing between sludge and water is poor, the volumetric gas evolution is lower and the treatment is less efficient.
- g) UASB reactors: 5 reactors with 18 modules each will be designed. Two columns of nine modules each will be placed. Water leaves the reactor at the top through an effluent collection system and is channeled into the ponds. Reactors will be constructed instead of primary anaerobic ponds. A Gas - Solid and Liquid separator (GLS separator), at the top of the reactor, permits the capture and storage of biogas produced during the anaerobic digestion.

- h) Stabilization ponds: A post-treatment is required because UASB reactors have a low effect on the concentration of macronutrients (nitrogen and phosphorus) and the pathogenic organisms are only partially removed. This implies an additional BOD<sub>5</sub> and Faecal Coliform removal. Aerobic ponds represent the best alternative for this case. Aerobic ponds can reduce BOD<sub>5</sub> until 70% and, Faecal Coliform until 90%. Design and operating conditions will be verified for this section.
- i) Final discharge: Wastewater produced by the treatment is used for agricultural irrigation, with excess being discharged into the sea. A gate placed at the end of the exit channel regulates the flow. There is an open channel reinforced with concrete cover constructed by farmers and financed by FONCODES<sup>29</sup> for agricultural irrigations. The channel is 1.00 m depth, 2.00 m height and 1,000 m length. The channel which led the water to the sea is 3,500 m length. Farmers, downstream, are taking illegally the water for their fields.

### 3.2.2. Biogas treatment

Biogas from UASB reactor is collected at the top by the GLS separator. The biogas generated normally has a high methane (50 - 75%) and carbon dioxide (25 - 40%) content, some hydrogen (1.0 - 3.0%), nitrogen (0.25 - 2.5%), oxygen (0.1 - 1.0%), hydrogen sulphide (0.1 - 0.5%), ammonia (0.1 - 0.2%), carbon monoxide (0.1 - 0.2%) and water vapor (0.1 - 0.2%) (Osorio et al, 2009). Some experimental research studies have indicated that a successful LHV (Low Heating Value) which is approximately 18 - 27 MJ/m<sup>3</sup> (Nijaguna, 2002). Biogas has to be treated before its use in combustion engines in order to avoid corrosion troubles due to hydrogen sulphide. Energy generated can be used for powering the plant itself and excesses can be fed to the national energy grid.

Steps of biogas treatment are the following:

- a) Storage: When GLS separator exceeds its biogas storage capacity, a gas holder is necessary. The proposal plan intends to calculate the amount of gas generated and the storage capacity.
- b) Desulphurization process: Presence of H<sub>2</sub>S causes bad odors and irreparable damages in metallic pipes, tanks, and makes unusable the combustion engine. Then, the removal of hydrogen sulphide is necessary. The methods for hydrogen sulphide elimination can also eliminate big quantities of carbon dioxide. One of those methods is using iron filings on purified columns.
- c) Combustion engine: Electricity and heat generation is one of the aims of this work. The combustion of biogas would be carry out in an internal combustion engine. Then, the electricity would be used for cover energy needs and the heat would be used for keeping the temperature inside the reactors.

---

<sup>29</sup> FONCODES is the Spanish acronym for Fondo de Cooperación para el desarrollo social.

- d) Auxiliary equipment: By-pass and gas holders are absolutely necessary for combustion of eventual biogas excesses.

### 3.2.3. Sludge treatment

As well as in the case of biogas, sludge from UASB reactor represents a resource for future applications. Sludge has a high content of organic matter and nutrients. It can be applied as a bio-fertilizer to increase the land quality. However, a more beneficial use of sludge is energy recovery and application. Some studies on domestic sewage sludge have shown that sludge represents a residue with a modest/high energy content. [Ginoris et al, 2010].

Steps of sludge treatment are the following:

- a) Sludge sampling and discharge system: The design of the reactor comprises a group of valves and piping that allows both sampling and discharge of the bio-solids presents in the reactor. The sampling system is a series of valves installed along the height of the sludge blanket compartment, to enable the monitoring of the growth and quality of the biomass in the reactor, it is one of the most important operational routines. The discharge system allows the periodical removal of the excess sludge produced in the reactor, also permits the removal of inert material that may accumulate at the bottom of reactor [De Lemos 2007].
- b) Sludge drying bed: Sludge would be dried through natural dehydration and evaporation. This process can achieve high levels of dryness with zero energy consumption; but, it is important the control of bad odors because it would be a source of insects proliferation especially with populations close to the plant and the road Chiclayo-San José because has a high index of vehicle traffic at any times of the day.
- c) Sludge utilization: Dry sludge has some applications. Developing countries are researching on land applications, mainly in the agriculture. Economically, dry sludge permits to save money, because reduce the employment of conventional fertilizers and does not affect the quality and amount of production. Other way is fuel from conversion of dried sludge through, e.g., gasification processes. Gasification represents many advantages, as the complete sterilization of sludge and a significant reduction in volume for its disposal.

Figure 3.1 represents the proposed configuration for a large-scale UASB plant.

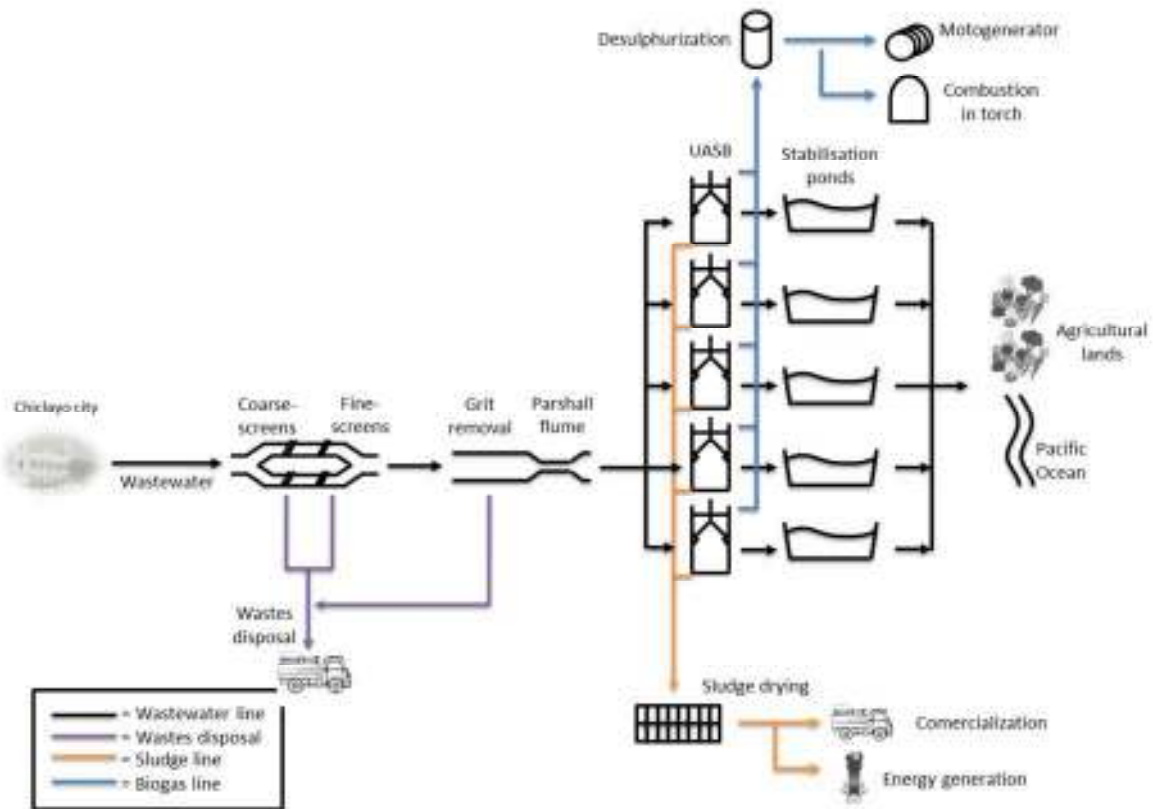

Figure 3.1: Proposal of wastewater treatment for sewage from Chiclayo city.

### 3.3. Sizing plant

The aim of this chapter is the development of the proposal for an adaptation of the current sewage system, analyzing and evaluating the operational conditions in the San José plant. Each step for this proposal will be identified, verified, analyzed and designed. A theoretical calculation of performance and final efficiency will do it based on conservative parameters in order to obtain final effluent operating values for comparison with current values. In other words, the feasibility of this proposal will be analyzed.

#### 3.3.1. Sewage treatment

##### 3.3.1.1. Preliminary treatment

###### *Coarse and fine screens*

At the present time, the quantity of solids present in the raw sewage is unknown, therefore the screen performance calculation is based on very theoretical values. Current plant has only two units of coarse screens placed in a main entrance channel. This channel is an open channel and has the following dimensions: the initial sector of the main channel has a rectangular cross-section, 2.00 m width and 1.30 m depth; performance



measurement takes place upstream over a 10.00 meter length, after the channel is divided in two secondary channels, each of 14.00 m length, 1.53 m width and 1.30 m depth, so the flow rate is also divided into half. The two channels are unified again to create a single downstream channel, with a length of 6.00 m assumed for performance measurements. Two screen units are introduced in parallel into the two secondary channels. The current coarse bars have a distance between bars of 0.0635 m and size of the bars of 0.0254 m. The new fine screens would have a distance between bars of 0.006 m and the size of bars would be also 0.006 m. Figure 3.2 illustrates this schema.

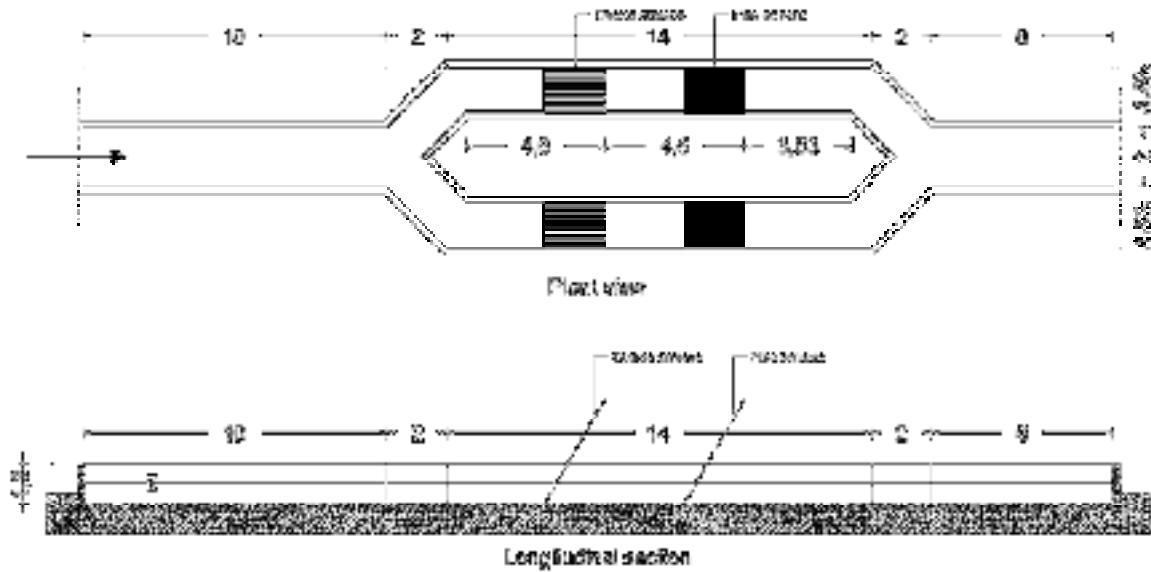

Figure 3.2: Screen channel schema

Hydraulic conditions and the structure of screen channel have been verified using the HEC-RAS<sup>30</sup> software, resolving the following equation with an iterative procedure ( $u$  and  $d$  subscripts stand for upstream and downstream respectively):

$$z_u + h_u + \frac{a_u \cdot V_u^2}{2g} = z_d + h_d + \frac{a_d \cdot V_d^2}{2g} + \Delta H \quad (3.1)$$

Where,  $\Delta H$  relates to abrupt narrowing (n) or abrupt widening (w):

$$\Delta H_{(n/w)} = k_{n/w} \frac{V^2}{2g} \quad (3.2)$$

Where:  $V$  is the channel velocity;  $g$  is the acceleration due to gravity, and  $k$  is head loss coefficient determined dependent on the sections. The  $k$  value for abrupt narrowing is:

$$k_{(n)} = 0.5(1 - (\omega_d/\omega_u)^2)^2 \quad (3.3)$$

And,  $k$  value for the abrupt widening is:

$$k_{(w)} = (1 - (\omega_u/\omega_d)^2)^2 \quad (3.4)$$

<sup>30</sup> HEC-RAS is the acronym for "Hydrologic Engineering Centers - River Analysis System".

Where  $\omega_u$  and  $\omega_d$  are the width of upstream and downstream channel respectively.  $\omega_u$  is 2.00 m and  $\omega_d$  is 3.06 m. And, head losses for the bar screen are:

$$\Delta H = K \cdot \left(\frac{s}{b}\right)^{1/3} \cdot \frac{v^2}{2g} \quad (3.5)$$

K depends on the bar shape (for a circular bar  $K = 1.79$ ).

The HEC-RAS software allows the performed one-dimensional steady flow, unsteady flow calculations; sediments transport mobile bed computations and water temperature modeling. HEC-RAS is helpful for the performance of hydraulic calculations in natural and constructed channels [US Army Corps of Engineers, 2010]. Thanks to its basic computational procedure, one-dimensional water surface profile and velocities can be shown. The software takes into account the land slope and its geographical position; the plant is located 4 a.m.s.l., 9 km from the Pacific Ocean and 6 km from Chiclayo city.

According to the results of HEC-RAS model, under normal operating conditions, the water surface level can reach a maximum depth of 0.65 m and a minimum depth of 0.47 m due to head losses and the bottom slope. Head losses due to the abrupt widening and abrupt narrowing are approximately 0.11 m and 0.02 m, respectively. In the screen channel, head losses due to the coarse screens and fine screens are approximately 0.01 m and 0.02 m, respectively. Figure 3.3 shows the water and critical depth profile.

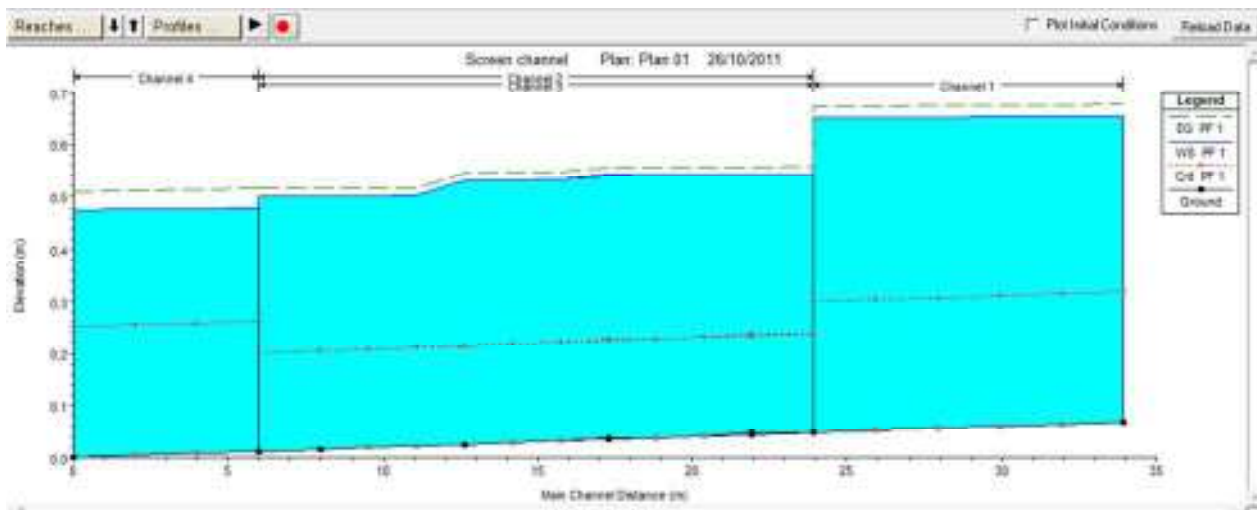

Figure 3.3: 2-D profile plot of results from HEC-RAS

Head losses due to abrupt widening and abrupt narrowing cause large variations in velocity, while head losses due to the fine and coarse screens cause low variations in velocity. The velocity values obtained by means of the simulation agree with the standard values established in literature and by Peruvian regulation [VIVIENDA, 2009] for this kind of channel in wastewater treatment plants

It is very important to have a free board because in this way it can support excess flow when there is an overload of flow due to maintenance or repair works. The software

permits to verify the particular velocities and water surfaces for each single section of the channel (one section cover about 2.00 m length).

Parameters used in the software are showed in the table 3.9.

Table 3.9: Main parameters for check and control screen process.

<i>Parameter</i>	<i>Value</i>	<i>Unit</i>
<i>Main influent channel</i>		
Design flow rate	0.792	m <sup>3</sup> /h
Bottom channel slope	0.002	m/m
Channel width	2.00	m
Channel depth	1.30	m
Upstream channel length	10.00	m
Downstream channel length	6.00	m
Total channel (pretreatment)	34.00	m
Manning's value	0.015	m <sup>1/3</sup> /s
Headlosses upstream	0.02	m
Headlosses downstream	0.10	m
<i>Coarse screens</i>		
Lines of treatment	2.00	#
Bottom channel slope	0.002	m/m
Channel width	1.53	m
Total channel lenght	14.00	m
Manning's value	0.015	m <sup>1/3</sup> /s
Bar spacing	0.0635	m
Bar size	0.0254	m
Inclination angle (vertical reference)	30.00	°C
Number of bars	17.00	#
Headlosses	0.008	m
<i>Fine screens</i>		
Lines of treatment	2.00	#
Bottom channel slope	0.002	m/m
Channel width	1.53	m
Total channel lenght	14.00	m
Manning's value	0.015	m <sup>1/3</sup> /s
Bar spacing	0.006	m
Bar size	0.006	m
Inclination angle (vertical reference)	30.00	°C
Number of bars	127.00	#
Headlosses	0.024	m

Source: adapted by [EPSEL S.A. 2010 and Metcalf & Eddy, 2003]

The table 3.10 shows the results by HEC -RAS model: water surface level and velocities for each section. Figure 3.4 shows the results of HEC-RAS model. It was divided in 4 main sections. The division was based according to the momentum of hydraulic jumps. "Channel 1" includes 10 first meters from downstream to upstream of entrance channel, from 9.0 to 10.0 sections. "Channel 2/3" has 14 meters long, it includes the abrupt narrowing of the main channel, screens sections and abrupt widening of the secondary channels, it receives the name of "Channel 2/3" because represents the two screens channel (two units of coarse screens and two units of coarse screens placed in parallel). It included the section from 3.0 to 8.0. Finally "channel 4" refers at the end of the channel, afterwards, water is lead to the grit removal basin. This final section has 6 meters long, and includes the section 1.0 and 2.0. The whole channel has 34.00 m total length, the sizes of channel have been provided by EPSEL.

At present, the channel has 1.80 m depth. 0.5 m of them is below ground level and 1.3 m is up ground level. According to the results of HEC-RAS model, in normal operative conditions the water surface level can get 0.65 m high as maximum in "Channel 1", and 0.47 m as minimum due to head losses and bottom slope. Head losses, due to the abrupt widening and the abrupt narrowing, are about 11.00 cm and 2.00 cm of water columns respectively. In the screen channel, head losses due to coarse screens and fine screens are about 1.00 cm and 2.00 cm respectively. The velocities in the different sections are variable (non-uniform motion). They are decreasing from the end of the channel to the screen channel (from downstream to upstream). They are constants between fine and coarse screens. And, they are increasing from channel screens to the beginning of the channel.

Figure 3.5 shows the water surface profile considering the head losses in the sections of abrupt widening, abrupt narrowing, fine and coarse screens. Fine and coarse screens are not visible in the plot of the channel profile, but head losses have been introduced and taken account in the software.

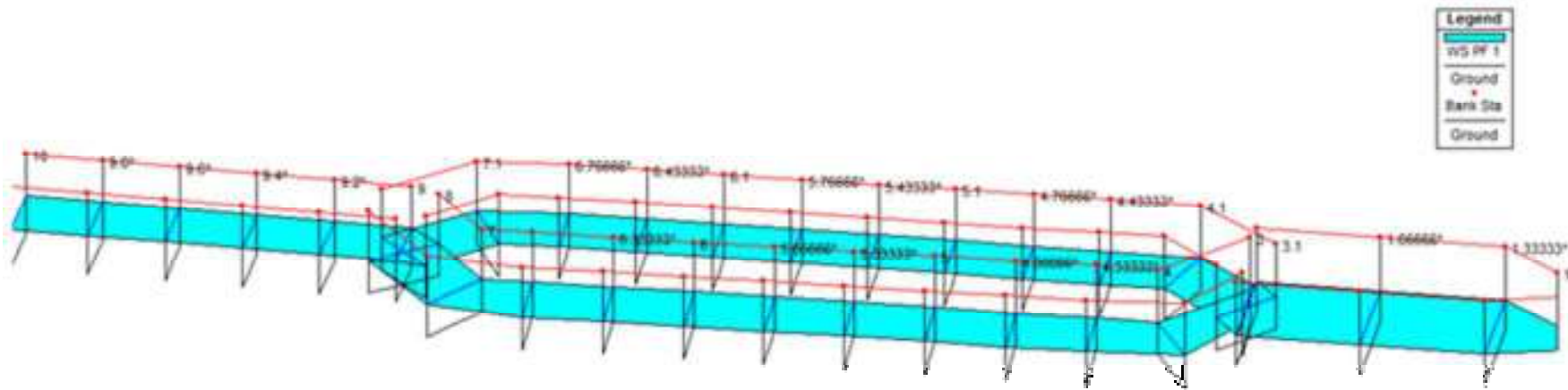

Figure 3.4: 3D perspective plot. (Screens head losses have been taken account).

Table 3.10: Profile output table by HEC-RAS.

Reach	Channel Section	Lenght (m)	Profile	HEC-RAS Plan: Plan 01		Profile: PF 01				
				Q Total (m <sup>3</sup> /s)	W.S. Elev* (m)	Crit W.S. (m)	E.G. Elev (m)	E.G. Slope (m/m)	Vel Chnl (m/s)	Flow Area (m <sup>2</sup> )
Channel 1	10.0	34.0	PF 1	0.79	0.65	0.32	0.68	0.000386	0.68	1.17
Channel 1	9.8	32.0	PF 1	0.79	0.65	0.31	0.68	0.000380	0.67	1.18
Channel 1	9.6	30.0	PF 1	0.79	0.65	0.31	0.68	0.000374	0.67	1.19
Channel 1	9.4	28.0	PF 1	0.79	0.65	0.31	0.68	0.000368	0.66	1.19
Channel 1	9.2	26.0	PF 1	0.79	0.65	0.30	0.67	0.000362	0.66	1.20
Channel 1	9.0	24.0	PF 1	0.79	0.65	0.30	0.67	0.000356	0.66	1.21
Channel 2/3	8.0	24.0	PF 1	0.4	0.54	0.24	0.56	0.000305	0.52	0.76
Channel 2/3	7.0	22.0	PF 1	0.4	0.54	0.23	0.56	0.000299	0.52	0.76
Channel 2/3	6.6	20.2	PF 1	0.4	0.54	0.23	0.56	0.000295	0.52	0.77
Channel 2/3	6.3	18.8	PF 1	0.4	0.54	0.23	0.56	0.000291	0.51	0.77
Channel 2/3	6.0	17.4	PF 1	0.4	0.54	0.22	0.55	0.000286	0.51	0.77
Channel 2/3	5.6	15.8	PF 1	0.4	0.53	0.22	0.55	0.000295	0.52	0.77
Channel 2/3	5.3	14.2	PF 1	0.4	0.53	0.22	0.55	0.000290	0.51	0.77
Channel 2/3	5.0	12.8	PF 1	0.4	0.53	0.21	0.55	0.000285	0.51	0.78
Channel 2/3	4.6	11.0	PF 1	0.4	0.50	0.21	0.52	0.000332	0.54	0.74
Channel 2/3	4.3	9.6	PF 1	0.4	0.50	0.21	0.52	0.000327	0.54	0.74
Channel 2/3	4.0	8.0	PF 1	0.4	0.50	0.21	0.52	0.000322	0.53	0.74
Channel 2/3	3.0	6.0	PF 1	0.4	0.50	0.20	0.52	0.000316	0.53	0.75
Channel 4	2.0	6.0	PF 1	0.79	0.48	0.26	0.52	0.000745	0.85	0.93
Channel 4	1.6	4.0	PF 1	0.79	0.48	0.26	0.51	0.000733	0.84	0.94
Channel 4	1.3	2.0	PF 1	0.79	0.48	0.25	0.51	0.000721	0.84	0.94
Channel 4	1.0	0.0	PF 1	0.79	0.47	0.25	0.51	0.000709	0.83	0.95

\* Calculated water surface from energy equation

\* Manning's value: 0,015 m<sup>1/3</sup>/s.

\* Coarse screens: reach 2/3 - Channel section: 6.0 (s=0.0635m; b= 0.0254m; # bars = 17; ΔH = 0,008m)

\* Fine screens: reach 2/3 - Channel section: 5.0 (s=0.006m; b= 0.006m; # bars = 127; ΔH = 0,024m)

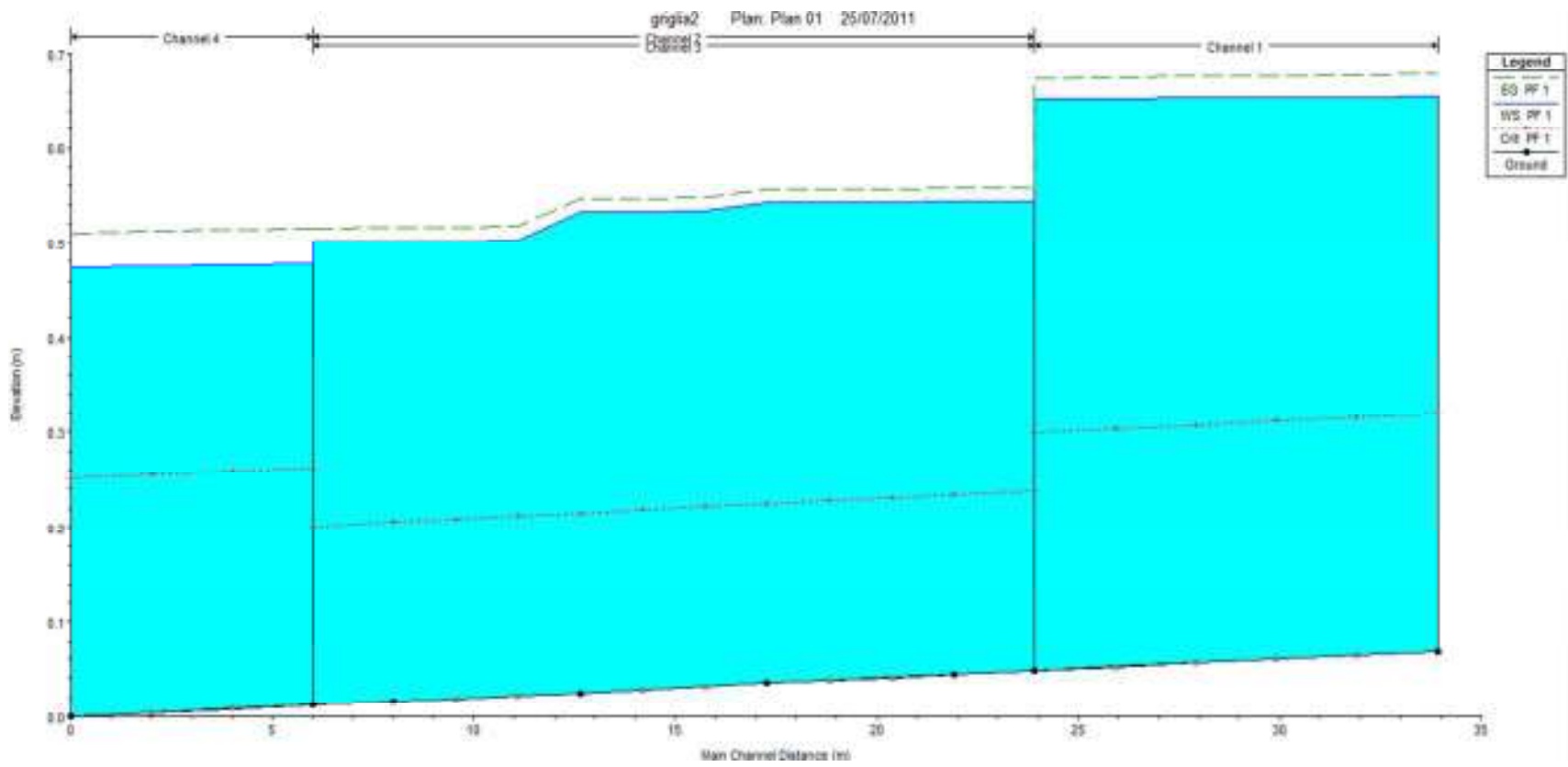

Figure 3.5: 2D Profile plot.

### *Grit chamber and Parshall flume*

It is particularly important to avoid accumulation of inorganic solids and obstruction pipes in the reactor [Heffernan et al, 2012 and Bonomo, 2008]. In this way a grit chamber must be installed. An easy and attractive design is a grit channel and Parshall flume combination [Van Haandel et al, 1994]. It has advantages of easy and low cost of construction and small head losses and permits the control of velocity in the channel, the avoiding pumping of sewage is an important aspect.

For the grit chamber design, the following parameters and operating margins were taken into account [Lubello, 2006]:

- Surface hydraulic load, SHL ( $\text{m}^3/\text{m}^2\text{h}$ ):  $< 45 \text{ m}^3/\text{m}^2\text{h}$
- Hydraulic retention time, HRT (min): 2.00 – 5.00 min. Typically 4 min.
- Typical length, L (m): 15.00 m. (7.50 – 20.00 m).

Adequate dimensions, good hydraulic retention times and good velocities are necessary to ensure that organics are not removed together with sand and grit and are carried out the channel and led to the reactor [Metcalf & Eddy, 2003 and Lubello, 2006]. Following mathematical relations were used for sizing and determining the characteristics of the grit chamber [Lubello, 2006]:

$$V = Q \cdot HRT \quad (3.6)$$

Where volume, V ( $\text{m}^3$ ); Q is the average total flow rate ( $\text{m}^3/\text{h}$ ); HRT (min) is 0.067 h; channel total depth, H (m) is 3 m.

The surface area  $A_s$  ( $\text{m}^2$ ) is calculated by:

$$A_s = V/H \quad (3.7)$$

Then, the verification of  $SHL_{max}$  ( $\text{m}^3/\text{m}^2\text{h}$ ) is determined by:

$$SHL_{max} = Q/A_s \quad (3.8)$$

Dimensions can be calculated by:

$$B = A_s/L \quad (3.9)$$

Where, B is the width of channel.

Others verifying recommended relations are:

$$B/H = 1:1 - 5:1 \quad (3.10)$$

$$L/B = 3:1 - 5:1 \quad (3.11)$$

$$A_t = B \cdot H \quad (3.12)$$



Where,  $A_t$  ( $m^2$ ) is the cross sectional area of the grit channel. Now, the velocity  $V_t$  (m/h) is expressed as:

$$V_t = Q/A_t \quad (3.13)$$

The conditions of grit storage are determined using the following equation:

$$V_c = C_p \cdot D_g \cdot Q \quad (3.14)$$

Where,  $V_c$  is the accumulation of grit during the operational time ( $m^3$ );  $C_p$  is the operational time practically measured in days equivalent to 168 hours;  $D_g$  is the deposition of grit assumed as  $0.075 m^3$  of grit per  $1.000 m^3$  of sewage [Van Haandel et al, 1994].

The depth of grit layer  $H_g$  (m) is measured by:

$$H_g = V_c/A_s \quad (3.15)$$

An acceptable value is 1.00 m [16]. Then, the useful depth  $H_t$  could be expressed as:

$$H_t = H - H_g \quad (3.16)$$

Table 3.11 shows dimensional characteristics and operating conditions.

Table 3.11: Grit channel characteristics

<i>Grit removal: horizontal grit channel</i>		<i>Value</i>	<i>Unit</i>
Number of treatment lines	N.	1.00	#
Design flow rate	$Q$	2,853.03	$m^3/h$
Grit channel width	$B$	4.50	m
Grit channel length	$L$	15.00	m
Total depth	$H$	3.00	m
Useful depth	$H_t$	2.40	m
Cross-sectional area	$A_t$	12.70	$m^2$
Total surface area	$A_s$	63.50	$m^2$
Total volume	$V$	190.18	$m^3$
Hydraulic retention time for design flow rate	$HRT$	4.00	min
Surface hydraulic load for design flow rate	$SHL_{max}$	45.00	$m^3/m^2h$
Surface hydraulic load to medium flow rate	$SHL_{med}$	34.47	$m^3/m^2h$
Cross-sectional velocity	$V_t$	1.8 – 2.4	m/h
Volume of grit	$V_c$	36.00	$m^3$
Depth of grit layer	$H_g$	0.60	m
Cleaning period	$C_p$	7.00	days

*Check pass of Parshall flume.*

The sewage is forced through a narrow throat in the Parshall flume. The throat width and other critical dimensions are standardized [Van Haandel et al, 1994]. The water level is measured at a point places at two-thirds of the channel approaching the throat. The following equation represents the flow rate measured at the level reference according to Van Haandel and Lettinga:

$$Q_t = 2.3 \cdot \psi \cdot (H_A^{1.5}) \quad (3.17)$$

Where:  $Q_t$  = sewage flow rate (m<sup>3</sup>/h),  $\psi$  = throat width (m),  $H_A$  = head upstream at measuring point (m). The sewage flow rate can also be measured by this empirical relationship adopted principally in the Central and South American projects:

$$Q_t = \alpha \cdot (H_A^\beta) \quad (3.18)$$

Where  $\alpha$  is equal to 2.387 and  $\beta$  is equal to 1.569, factors dependent on the throat width [Pedroza, 2001], the values of which are defined empirically from large-scale plants. The equations have been tested using the data provided by Epsel relating to the Parshall flume structure, flow rates and water levels measured up to December 2011, and the results obtained were identical for both equations, those results are shown in the table 3.12.

Table 3.12: Flow rates from EPSEL S.A. and tested.

<i>Depth (<math>H_A</math>)</i>	<i>Throat width using eq. 3.17</i>	<i>Flow rate from Epsel</i>	<i>Flow rate using eq. 3.18</i>
<i>m</i>	<i>m</i>	<i>m<sup>3</sup>/s</i>	<i>m<sup>3</sup>/s</i>
0.250	0.942	0.271	0.270
0.275	0.951	0.316	0.314
0.300	0.957	0.362	0.359
0.325	0.962	0.410	0.408
0.350	0.967	0.461	0.458
0.375	0.971	0.513	0.510
0.400	0.976	0.568	0.565
0.425	0.980	0.625	0.621
0.450	0.984	0.683	0.679
0.475	0.987	0.744	0.739
0.500	0.991	0.806	0.801
0.525	0.995	0.870	0.865
0.550	0.998	0.936	0.931

AutoCAD 2011 was used to develop the combination of Parshall flume with grit channel shown in Figure 3.6.

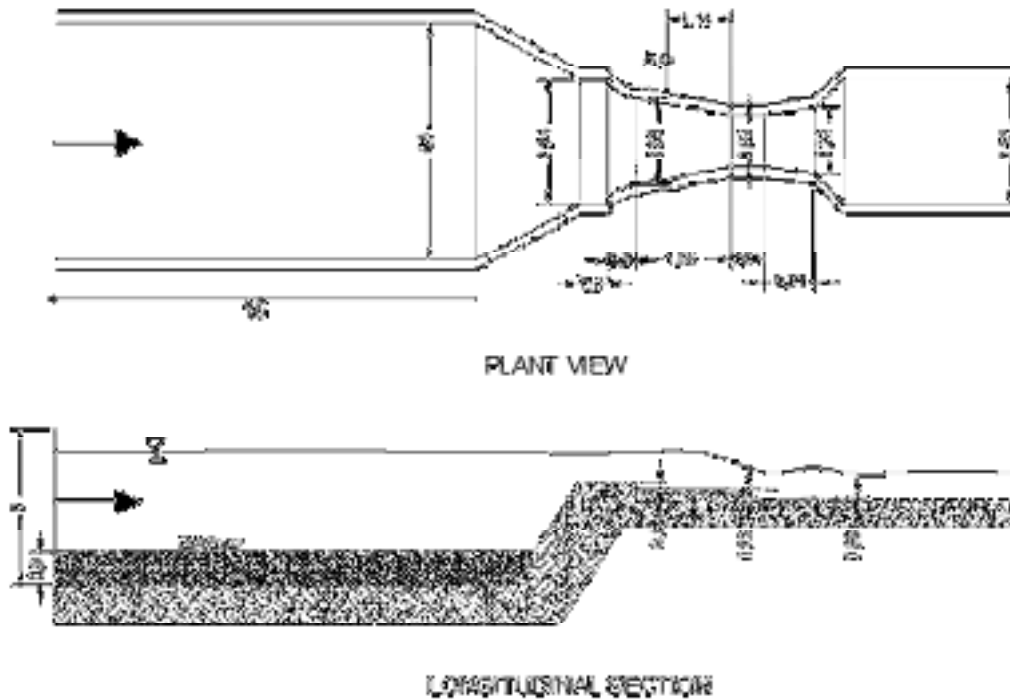

Figure 3.6: Grit removal with Parshall flume: plant view and longitudinal section.

### 3.3.1.2. Biological treatment: UASB reactors

#### *Design of UASB reactor*

The treatment of wastewater in pilot and experimental-scale UASB reactors has been subject to intense research over the last decades. Some applications in Europe have been orientated towards treating industrial sewage, while in Latin America and many developing countries around the world; the orientation is towards domestic sewage. These reactors work satisfactorily, achieving BOD<sub>5</sub> removal efficiencies of up to 85% with a HRT of 5 hours [Van Haandel et al, 1994]; for pilot or large-scale reactors BOD<sub>5</sub> removal efficiencies of between 60 - 75% can be obtained with a HRT of 4 - 6 hours. UASB reactors combined with stabilisation ponds can be seen, therefore, to be technically and economically feasible, representing an important alternative for the reuse of treated sewage and with related environmental protection benefits.

Sizing is based on the Italian know-how and on the best real-scale project experience in Latin America: the Rio Frio WWTP. For this case, a modular design was assumed calculating the need for 5 reactors each of 18 modules (See table 3.13).

Table 3.13: Projection parameters from UASB reactor design of Wastewater treatment Plant in Bucaramanga, Colombia.

Year	# population	Flow rate (m <sup>3</sup> /d)	Organic loading (kg BOD/d)	# UASB Reactors
1991	153,000	32,141	4,590	2
1993	180,000	37,843	5,400	3
1998	220,000	48,224	6,600	3
2003	280,000	58,838	8,400	4
2008	340,000	71,366	10,200	5
<i>Current Rio Frio WWTP characteristics:</i>				
2011 - 2012	500,000	55,296	10,500	4
<i>Characteristics for San José WWTP:</i>				
-	332,000	68,464	11,904	5

Source: [Montalvo et al, 2003 and Chavez, 2009].

### Reactor volume and dimensions

Volume and dimensions are determined by HRT and up-flow velocity mainly. A first approximation for hydraulic retention time and flow rate by each module must be considered. Then, volume of a module and total module liquid volume are determined through the following equations:

$$V_n = Q_m \cdot HRT \quad (3.19)$$

$$V_L = V_n / E \quad (3.20)$$

Where:  $V_n$  is the module volume or effective volume, while  $V_L$  is the total module liquid volume, the sludge bed volume is included in the  $V_L$ , it is calculated applying an effective factor  $E$  equivalent to 0.85 [Metcalf & Eddy, 2003].  $Q_m$  is the total flow rate by module equivalent to 31.7 m<sup>3</sup>/h. HRT is strongly dependent on temperature, when the temperature is in the range 22 – 26°C, about 6 hours are acceptable [Azimi et al, 2004].

Total module liquid volume and effective module volume are 186.50 m<sup>3</sup> and 158.50 m<sup>3</sup> respectively.

Cross sectional area and dimensions for each single module could be calculated considering and assuming the up-flow velocity of water inside the reactor.

$$A_m = Q_m / v_{up} \quad (3.21)$$

Where  $A_m$  is the area and  $Q_m$  is the flow rate for a single module. The area is 47.5 m<sup>2</sup>. The maximum up-flow velocity  $v_{up}$  should be 0.7 m/h, it has an important impact on the efficiency of organic matter removal and avoids the wash up of biomass. In a conventional UASB system and treating domestic sewage, the average daily value of up-flow velocity must not exceed 1 m/h. The module has a rectangular section where width is about the half of the length, the dimensions of the module are 5.0 m and 9.5 m for width and length

respectively. Total extensive area can be calculated applying principles of plant planning and surfaces calculations, the total area for reactors is 9,747.0 m<sup>2</sup>.

The liquid height of the reactor is determined by:

$$H_L = V_L/A_m \quad (3.22)$$

Where,  $H_L$  is the liquid height, it is 4.1 m.

Reactor depths treating domestic sewage of 3.0 – 5.0 m are recommended [Azimi et al, 2004]. The total height of the reactor is the sum of the liquid height and the gas collector. The height of gas collector is about 1.0 – 1.5 m for reactor taller about 4.0 – 6.0 m and it is economically feasible to get total height on this range [Lettinga, 1991]. Many full scale experiences demonstrate this performance, moreover, reactors tallest 7.0 m must not be recommended [Azimi et al, 2004]. Thus the following relationship is applying:

$$H_T = H_L + H_G \quad (3.23)$$

Where,  $H_T$  is the total height of the reactor which is 5.5 m, and  $H_G$  is the height of the gas collector.

The liquid up-flow velocity in the reactor is directly correlated with the reactor height. High liquid velocities can increase the turbulence in the system at the inlet zone and hence the contact between the sludge and the incoming wastewater [Seghezzo et al, 1998]. The relationship between the up-flow velocity and the dimensions of the UASB reactor is given by:

$$v_{up} = Q_m/A_m = V_L/(HRT \cdot A_m) = H_L/HRT \quad (3.24)$$

### Volumetric organic load

COD loading is a function of the wastewater strength and temperature. The volumetric organic load is defined as the mass of organic matter applied to the reactor, per volume unit. Treating domestic sewage (low and very low strength wastewater, lower than 1,000 mgCOD/l) the volumetric organic load to be applied must be in the range 1.5 – 4.0 kgCOD · m<sup>3</sup>/d. Higher values cause excessive hydraulic loads and consequently excessive up-flow velocities. Applying expression 3.25 it is obtained:

$$L_{org} = (Q_m \cdot S_{COD})/V_n = 1.63 \text{ kgCOD} \cdot \text{m}^3/\text{d} \quad (3.25)$$

Where  $L_{org}$  is the volumetric organic load (results 1.63 kgCOD.m<sup>3</sup>/d);  $Q_m$  is the flow rate for a single module in m<sup>3</sup>/d;  $S_{COD}$  is the organic concentration in kgCOD/m<sup>3</sup>.

### Influent distributions system

The number of distribution tubes or inlet points ( $N_d$ ) is determined according to the reactor cross-sectional area and the area covered by each distributor  $A_p$  [De Lemos, 2007]. Considering the Rio Frio experience, about 2.6 m<sup>2</sup> influence area is acceptable, then 18 inlet points would be installed. The number of tubes is calculated using the expression:

$$N_d = A_m / A_p = 18 \quad (3.26)$$

Latin American experiences have shown that distribution tubes with a diameter of 0.1 m are sufficient to maintain a sewage velocity under 0.2 m/s, in order to avoid air bubbles and prevent tube obstruction from solids still present in the influent.

According to Haandel and Lettinga, the influence area should be ranging from 1.0 to 4.0 in full-scale UASB, as presented in table 3.14.

Table 3.14: Parameters of influent distribution in UASB reactors experiences treating domestic sewage.

<i>System</i>	<i>Volume (m<sup>3</sup>)</i>	<i>Liquid height (m)</i>	<i>Influence area (m<sup>2</sup>)</i>
Pedregal (Paraiba, Brazil)	160.00	4.0	2.0 – 4.0
São Paulo (Brazil)	120.00	4.8	2.0
Bucaramanga (Colombia)	3,300.00	4.0	2.9
Cali (Colombia)	64.00	4.0	1.0 – 4.0
Kanpur (India)	1,200.00	-	3.7

Source: Adapted by [Van Haandel et al, 1994] and [Montalvo et al, 2003].

### Three phase separator

The GLS separator is installed in the upper part of the reactor. It collects the biogas escaping from the liquid phase separator and allows the suspended solids in the upper part of the reactor to settle. At the same time, it helps maintain the effluent TSS concentration low, and creates the space above the separator for the sludge bed to accommodate expansion resulting from temporarily high hydraulic loads [De Lemos, 2007].

For the correct performance of GLS separator device, the biogas produced in the digestion zone should not reaches the settling zone; if this condition is not met, the resulting turbulence in the settler will lead to a decrease in the settling efficiency and loss of the produce biogas as well as the sludge [Van Haandel et al, 1994]. Once the gas is effectively removed, the sludge can be separated from the liquid in the settling compartment, and then returned to the digestion compartment. Due to these reasons the GLS separator could be composed of a set of gas collector elements at the top of the reactor and a layer of gas deflectors beneath the apertures between these gas collection elements. In principle the design of the GLS separator is fairly simple, and it doesn't constitute a very expensive part of the reactor.

Its design depends on the characteristics of the wastewater, type of sludge present in the reactor, the surface loading rate, the expected biogas production and the dimensions of the reactor. According to De Lemos, Surface loading rates and hydraulic retention times in the sedimentation compartment are giving by the table 3.15.

Table 3.15: Surface loading rates and hydraulic retention time in the sedimentation compartment.

<i>Influent flow</i>	<i>Surface loading rate (m/h)</i>	<i>Hydraulic retention time (h)</i>	<i>Velocity in the aperture of sedimentation compartment (m/h)</i>
Average flow	0.6 - 0.8	1.5 - 2.0	<2.0 - 2.3
Maximum flow	<1.2	>1.0	<4.0 - 4.2
Temporary peak flows	<1.6	>0.6	<5.5 - 6.0

Source: [De Lemos, 2007]

Design is based on the Surface hydraulic load  $C_h$  (m/h), which is expressed as:

$$C_h = Q_m / A_m \quad (3.27)$$

The Surface hydraulic load is 0.68 m/h. Then, the velocity in the sedimentation compartment,  $v_f$  (m/h), can be determined applying the following expression:

$$v_f = 4 \cdot C_h \quad (3.28)$$

The velocity is 2.7 m/h. And, the opening area  $A_{op}$  (m<sup>2</sup>) of the compartment is 11.5 m given by:

$$A_{op} = Q_m / v_f \quad (3.29)$$

Two collectors would be installed by each module, then, each collector has 5.75 m<sup>2</sup> opening area. The area for each collector can be determined subtracting the opening area from the surface area of the module and divided by two. Thus, each single collector has 18.0 m<sup>2</sup> surface area. Dimensions of the collector are determined applying the following equations:

$$W_{GLS} = A_{GLS} / L_m \quad (3.30)$$

$$W_{op} = (W_m - 2 \cdot W_{GLS}) / 4 \quad (3.31)$$

Where,  $W_{GLS}$  is the collector width (2.0 m),  $A_{GLS}$  is the collector area,  $L_m$  is the length of module,  $W_{op}$  is the width of the opening area (0.25 m), and  $W_m$  is the width of the module. The dimensions of the collector are 9.0 m length and 2.0 m width considering 0.25 m width of opening area.

Then, the opening of walls can be determined by:

$$W_g = W_m/4 - W_{op} - 0,5(h_c) \quad (3.32)$$

Where:  $W_g$  is the opening of walls (results 0.75 m), and  $h_c$  is the height of gas collector assumed as 0.50 m. While, the height of sedimentation compartment  $h_s$  (m) is given by:

$$h_s = W_g \cdot \tan \alpha \quad (3.33)$$

And it results 1.30 m. Where  $\alpha$  is the angle of wall, equivalent to  $60^\circ$ .

The total height of GLS separator device  $H_{GLS}$  (m) is:

$$H_{GLS} = h_s + h_c \quad (3.34)$$

Deflectors must be installed and located immediately, about 0.20 m below the apertures of the sedimentation compartment, to enable the separation of the biogas, and allow only liquid and solids enter to the sedimentation compartment. The overlap would be assumed as 0.15 m, according to De Lemos, the overlap of the gas deflectors in relation to the opening for the settler compartment must be about about 0.10 - 0.15 m. Hence, the dimensions of deflector are given by:

$$l_D = W_{op} + 0.15 \quad (3.35)$$

And

$$h_D = l_D \cdot \tan \beta \quad (3.36)$$

Where,  $l_D$  is the length of the deflectors (0.40 m),  $h_D$  is the height of the deflectors (0.40 m),  $\beta$  is the angle applied to deflectors. It is equivalent to  $45^\circ$ . Regarding the Hydraulic retention time is given under the concept:

$$V_S = Q_m \cdot HRT_S \quad (3.37)$$

The volume of sedimentation compartment ( $V_S$ ) is about 58.24 m<sup>3</sup>, then, the hydraulic retention time in the sedimentation compartment ( $HRT_S$ ) is 1.84 hours. Ranging from 1 to 2 hours  $HRT_S$  is recommended.

Keeping acceptable values of liquid velocities in the GLS separator is important, even they can vary according to the reactor dimensions [Van Haandel et al, 1994]. The main velocities are given by:

$$v_{ap} = Q_m/A_{ap} = v_{up} \cdot A_m/A_{ap} \quad (3.38)$$

And

$$v_{di} = Q_m/A_{di} = v_{up} \cdot A_m/A_{di} \quad (3.39)$$



Where:  $v_{ap}$ ,  $v_{di}$  = up-flow velocities of the liquid at the base of the GLS separator and at the effluent discharge level respectively (m/h);  $A_{ap}$ ,  $A_{di}$  = areas for liquid at these levels (m<sup>2</sup>). 2.76 m/h is the up-flow velocity at the base of the GLS separator and 0.86 m/h is the velocity at the effluent discharge level.

Table 3.16 summarizes the design parameters of UASB reactor.

Table 3.16: Summary of UASB design

<i>Parameter</i>		<i>Value</i>	<i>Unit</i>
<i>Reactor and module</i>			
Number of reactors	-	5	#
Modules by each reactor	-	18	#
Type of design	-	rectangular	-
Flow rate of single module	$Q_m$	31.70	m <sup>3</sup> /h
Effective volume	$V_n$	158.50	m <sup>3</sup>
Total module liquid volume	$V_L$	186.50	m <sup>3</sup>
Hydraulic retention time	HRT	6	h
Module area	$A_m$	47.50	m <sup>2</sup>
Total reactor area	-	855.00	m <sup>2</sup>
Total extensive area	-	9,747.00	m <sup>2</sup>
Dimensions of each module	$W_m \times L_m \times H_L$	5.0 x 9.5 x 4.1	m x m x m
Total height of the reactor	$H_T$	5.5	m
Up-flow velocity	$v_{up}$	0.7	m/s
<i>Influent distribution system</i>			
Influence area	$A_p$	2.6	m <sup>2</sup>
Number of inlet points	$N_d$	18	#
Diameter of tubes	-	0.1	m
<i>Three phase separator</i>			
Number of GLS devices for each module	-	2.00	#
Velocity in the sedimentation compartment	$v_f$	2.7	m/h
Total opening area	$A_{op}$	11,89	m <sup>2</sup>
Height of sedimentation compartment	$h_S$	1.30	m
Total height of GLS separator	$H_{GLS}$	1.80	m
Angle applied for walls	$\alpha$	60.0	°
Angle applied for deflectors	$\beta$	45.0	°
Volume of sedimentation compartment	$V_S$	58.24	m <sup>3</sup>
HRT of sedimentation compartment	$HRT_S$	1.8	h
Velocity at the base of GLS separator	$v_{ap}$	2.76	m/h
Velocity at the effluent discharge level	$v_{di}$	0,86	m/h

Figure 3.7 shows the schema of each section of the reactor, designed using AutoCAD, as described in the previous calculations.

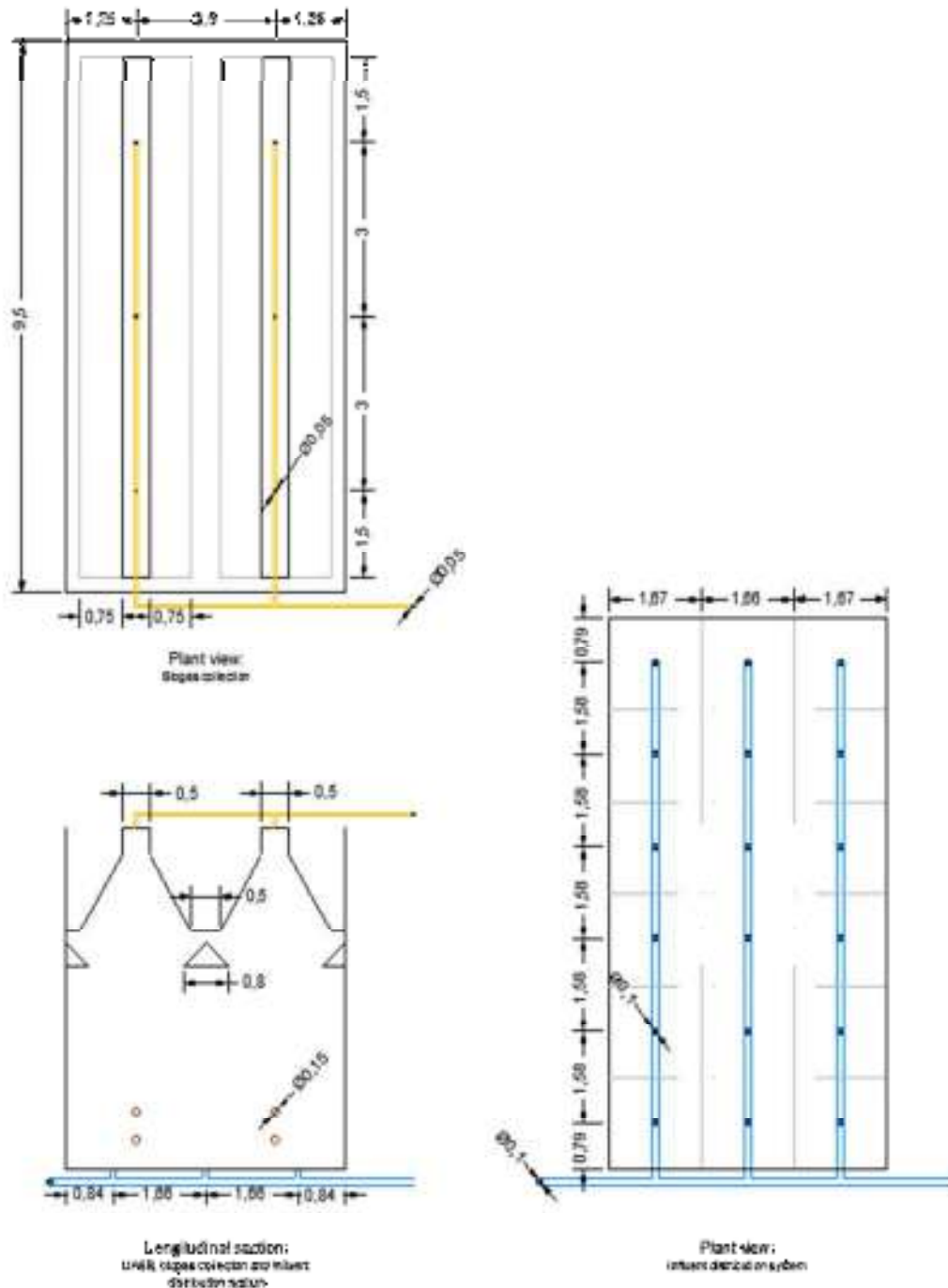

Figure 3.7: UASB reactor, biogas collection and influent distribution system

### Effluent collection

The effluent would be collect at the top of the reactor as uniformly as possible. A low cost design alternative is submerged perforated tubes which consist of a number of PVC tubes that draw off the water treated from beneath the water surface [De Lemos, 2007]. They are submerged at approximately 0.20 m under the water level. It is helpful to maintain a uniform flow in the holes, and decrease or eliminates the risk of turbulence as well as release of gases and bad odors.

When wastewater is discharge at their leveling, a scum baffler submerged should be included along the launder in order to retain the floating solids. Part of the material in the floating sludge layer consists of viable anaerobic active sludge, which rises in the wastewater due to occlusions of biogas bubbles, once the bubbles are released, the sludge will returned to the digestion zone of the reactor [De Lemos, 2007]. The discharge through tubes is visible and any obstruction can be detected easily, as cleaning is not always possible, it is recommended that the tubes are laid with a minimum slope of 1% so they that may be self-cleaned.

### Sludge sampling and discharge

The sludge sampling system consists of a series of valves installed along the height of the digestion compartment. It allows the growth and quality of the biomass in the reactor to be monitored, that is, to determine the solid profile, micro-organisms present in the system and the specific methanogen activity. In addition, determinate the quantity, frequency and determination of ideal sludge discharge point. The installation of valves is recommended from the base of the reactor with the following characteristics: spacing between them: 0.50 m; diameter of valves: 2 inches (or 100 mm as minimum); type of valves: ball valves.

### *Performance of UASB reactors: removal efficiencies*

The performance of the proposed reactor was determined in terms of COD, BOD<sub>5</sub> and Faecal Coliform removal efficiencies. TSS removal efficiency was difficult to determinate due to the lack of specific information on TSS. Removal efficiencies were estimated using empirical relationships obtained from experimental results of the task group of the International Water Association's (IWA) in relation to anaerobic digestion processes. They noted that COD and BOD<sub>5</sub> removal efficiencies are affected considerably by the hydraulic retention time of the system. Ranges from 40 to 75% for COD removal and from 35 to 80% for BOD<sub>5</sub> removal can be achieved [De Lemos, 2007 and Arena, et al, 2005] using:

$$E_{COD} = 100 \cdot (1 - 0.68 \cdot HRT^{-0,35}) \quad (3.40)$$

$$E_{BOD} = 100 \cdot (1 - 0.70 \cdot HRT^{-0,50}) \quad (3.41)$$

Meanwhile, Faecal Coliform (FC) efficiency depends on the die-off kinetic constant ( $\sigma$ ):

$$E_{FC} \rightarrow \ln \left[ \frac{N_{FC-UASB(o)}}{N_{FC-UASB}} \right] = \sigma \cdot HRT \quad (3.42)$$

where:

$$\sigma = \sigma(20^{\circ}C) \cdot (1.19^{(T-20)}) \quad (3.43)$$

Where  $E_{COD}$ ,  $E_{BOD}$  and  $E_{FC}$  are COD, BOD<sub>5</sub> and Faecal Coliform removal efficiency expressed in %. HRT in hours.

The  $\sigma$  ( $d^{-1}$ ) is influenced by the water temperature of the reactor (T is equal to 35°C), and  $\sigma(20^\circ C)$  is equal to 2.60  $d^{-1}$ . Removal efficiencies calculated for the UASB reactor are: 63.7%, 71.4% and 89.7% for COD, BOD<sub>5</sub> and Faecal Coliforms, respectively, with an HRT equal to 6 h. The UASB effluent concentrations can then be estimated using the following expressions:

$$S_{COD/BOD-UASB} = S_{COD/BOD-UASB(o)} - [(E_{COD/BOD} \cdot S_{COD/BOD-UASB(o)})/100] \quad (3.44)$$

$$N_{FC-UASB} = N_{FC-UASB(o)} / (1 + \sigma \cdot HRT) \quad (3.45)$$

Where S is expressed in mg/l and N is expressed in MPN/100ml. Then, 64.87 mg/l, 123.68 mg/l and 6.25E+06 MPN/100ml were found for BOD<sub>5</sub>, COD and Faecal Coliform concentrations in the UASB effluent.

Table 3.17 reassumes the parameters and results for the reactor performance.

Table 3.17: Design parameters and performance of San José municipal UASB treatment plant.

<i>Parameter</i>		<i>Value</i>	<i>Units</i>
BOD <sub>5</sub> concentration in the UASB influent	$S_{BOD-UASB(o)}$	227,01	mg/l
COD concentration in the UASB influent	$S_{COD-UASB(o)}$	340.52	mg/l
FC concentration in the UASB influent	$N_{FC-UASB(o)}$	4.11E+07	MPN/100ml
BOD <sub>5</sub> concentration in the UASB effluent	$S_{BOD-UASB}$	64.9	mg/l
COD concentration in the UASB effluent	$S_{COD-UASB}$	123.7	mg/l
FC concentration in the UASB effluent	$N_{FC-UASB}$	6.25E+06	MPN/100ml
BOD <sub>5</sub> removal efficiency	$E_{BOD}$	71.4	%
COD removal efficiency	$E_{COD}$	63.7	%
FC removal efficiency	$E_{FC}$	89.7	%

### 3.3.1.3. Post-treatment

Pathogenic organisms are only partially removed in a UASB [Von Sperling, 2007]. Then, a post treatment must be required for remove residual BOD<sub>5</sub> and TSS, and to reduce the concentration of pathogens. Several post-treatment processes can be applied to the UASB effluent. According to the Latin American experiences, stabilization ponds are a better option for post-treatment [Donaires, 2005]. They can contribute substantially to producing high pathogen removal efficiency, odour control and low sludge accumulation.

#### *Verifying and proposal for a post-treatment*

It is necessary to verify the current dimensions (245 m length, 242 m width and 1.80 m depth) in order to plan the operational conditions for the new configuration. The current ponds were designed as a serial process with anaerobic ponds; while in the proposal the UASB reactor would be followed by aerobic ponds in a serial process too. At least 10 days of retention time could be necessary for an efficient BOD<sub>5</sub> residual removal and pathogens removal and in order to keep aerobic conditions in facultative ponds a 1.8 m depth is essential.

In Peru, the regulation "S.090 - Wastewater Treatment Plants" from the National Building Regulation is applying. Processes and design criteria are indicated in this regulation.

A design based on organic load and surface loading rate is more flexible [Von Sperling, 2007 and CEPIS/OPS, 2005]. The organic load  $L_0$  (kg BOD<sub>5</sub>/d) can be calculated by the following empirical expression:

$$L_0 = S_{BOD-UASB} \cdot Q_p \quad (3.46)$$

If  $S_{BOD-UASB}$  is in kg/m<sup>3</sup> and  $Q_p$ , flow rate for a single pond, is in m<sup>3</sup>/d. The  $L_0$  is 888.30 kg/d.

The surface loading rate varies with local temperatures, in regions with moderate sunshine during the winter is in the range  $120 \times 10^{-4} - 240 \times 10^{-4}$  kg BOD<sub>5</sub>/m<sup>2</sup>.d according to CEPIS/OPS, 2005 and Cavalcanti, 2003, if  $T_c$  is in °C:

$$L_s = 350 \cdot (1.107 - 0.002 \cdot T_c)^{T_c - 25} \quad (3.47)$$

Where  $T_c$  is the air temperature for coldest month. Then,  $L_s$  is  $166.7 \times 10^{-4}$  BOD<sub>5</sub>/m<sup>2</sup>.d.

Table 3.18: Ranges of surface loading rates for different kind of climates.

<i>Kind of climate</i>	$L_s$
Regions with warm winter and high sunshine	240 - 350 kg BOD <sub>5</sub> /ha.d
Regions with moderate winter and sunshine	120 - 240 kg BOD <sub>5</sub> /ha.d
Regions with cold winter and low sunshine	100 - 180 kg BOD <sub>5</sub> /ha.d

Source: [Von Sperling, 2007]

Then, the area required (m<sup>2</sup>) for each pond is:

$$A_r = L_0 / L_s \quad (3.48)$$

So each pond needs 53,300 m<sup>2</sup>. The volume can then be found using the following equation:

$$V_p = \frac{Z}{6} \cdot [(L \cdot W) + (L - 2iZ)(W - 2iZ) + 4 \cdot (L - iZ)(W - iZ)] \quad (3.49)$$

Where  $Z$ ,  $L$  and  $W$  are pond dimensions: depth, length and width (m);  $i$  is the ratio between horizontal and vertical internal slope. The volume is 102,000 m<sup>3</sup> for each pond.

Hydraulic retention time in the ponds ( $\theta$ , days) would be determined by the following expression, if  $Q_p$  is in m<sup>3</sup>/d:

$$\theta = Fhc \cdot \frac{V_p}{Q_p} \quad (3.50)$$

Where  $Fhc$ , the hydraulic correction factor, is 1.2 for secondary stabilisation ponds. It produces the result that 10 days are necessary to achieve optimal levels of pathogen removal, using the five stabilisation ponds already operating.

### Performance of stabilizations ponds

The final effluent characteristics in the stabilisation ponds can be determined in terms of the final concentrations of BOD<sub>5</sub> ( $S_{BOD-P}$ , kg/m<sup>3</sup>) and Faecal Coliform ( $N_{FC-P}$ , MPN/100ml):

$$S_{BOD-P} = FSC \cdot \frac{S_{BOD-USB} \cdot 4 \cdot \gamma \cdot e^{((1-\gamma)/(2\delta))}}{(1+\gamma)^2} + S_{BOD-USB} \cdot Fia \quad (3.51)$$

$$N_{FC-P} = \frac{N_{FC-USB} \cdot 4 \cdot \gamma \cdot e^{((1-\gamma)/(2\delta))}}{(1+\gamma)^2} \quad (3.52)$$

If  $S_{BOD-USB}$  is in kg/m<sup>3</sup>.

$Fsc$ , sedimentation characteristic factor, as 0.9 and  $Fia$ , Intrinsic algae factor, as 0.3 can be assumed according to CEPIS/OPS, 2005 and P Cavalcanti, 2003.  $\gamma$  and  $\delta$  are pond dispersion factors given by:

$$\delta = \frac{1.158 \cdot [\theta \cdot (W+2Z)]^{0.489} \cdot W^{1.151}}{(T_c+42.5)^{0.734} \cdot (L \cdot Z)^{1.489}} \quad (3.53)$$

and,

$$\gamma = \sqrt{(1 + 4 \cdot \vartheta \cdot \theta \cdot \delta)} \quad (3.54)$$

Where  $\vartheta = \vartheta(20^\circ\text{C}) \cdot (1.19^{(T-20)})$ , which is the water temperature in the coldest month, according to table 3.19.  $\vartheta$  is 2.99 d<sup>-1</sup>.

Table 3.19: Relation between Died-off constant and temperature.

$T$ (°C)	$\vartheta$ (d <sup>-1</sup> )	$T$ (°C)	$\vartheta$ (d <sup>-1</sup> )
11	0.54	21	3.09
13	0.77	23	4.38
15	1.09	25	6.20
17	1.54	27	8.79
19	2.18	29	12.44

Source: [Donaires, 2005].

Thus, the stabilisation ponds can reach final BOD<sub>5</sub> and Faecal Coliform concentrations of approximately 20.14 mg/l and 4.9E+04 MPN/100ml (69% and 99% removal efficiencies, respectively). During the whole process, very high removal efficiencies can be achieved, 91% for BOD<sub>5</sub> and 99.9% for Faecal Coliform compared with 71.4% for BOD<sub>5</sub> and 90.5% for Faecal Coliform in current removals. At present, the effluent presents a BOD<sub>5</sub> concentration of 65 mg/l and a Faecal Coliform concentration of 3.9E+06 MNP/100 ml. It is important to note that the proposed solution complies with Peruvian laws, which

permit maximum concentration levels of approximately 100 mg BOD<sub>5</sub>/l and 1E+05 MPN/100ml of Faecal Coliform.

The following table reassumes the main characteristics of post-treatment with stabilization ponds and final effluent.

Table 3.20: Design parameters for Post-treatment and final effluent characteristics.

<i>Parameter</i>		<i>Value</i>	<i>Unit</i>
Flow rate for a single pond	$Q_p$	13,692.22	m <sup>3</sup> /d
Organic load in the influent	$L_o$	888.30	kgBOD <sub>5</sub> /d
Surface loading rate	$L_s$	166.7x10 <sup>-4</sup>	kgBOD <sub>5</sub> /m <sup>2</sup> .d
Area required by a single pond	$A_r$	53,300	m <sup>2</sup>
Pond dimensions	$L \times W \times Z$	245 x 242 x 1.8	m
Hydraulic retention time	$\theta$	10	d
Air temperature for coldest month	$T_C$	15	°C
Water temperature for coldest month	$T$	20	°C
BOD <sub>5</sub> concentration in the final effluent	$S_{BOD-P}$	20.14	mg/l
FC concentration in the final effluent	$N_{FC-P}$	4.96E+04	MPN/100ml
BOD <sub>5</sub> final removal efficiency	-	91	%
FC final removal efficiency	-	99.9	%

### 3.3.2. Sludge treatment

Sludge is accumulated at the bottom of the reactor and represents a potential source for energy generation. The sludge produced in systems operating at temperatures above 20°C is normally sufficiently stable to allow direct liquid-solid separation without prior treatment. It would be used as fertilizer in agriculture or disposed of in some other way.

#### 3.3.2.1. Sludge production and discharge frequency.

Table 3.21: Up-flow rate, average concentration and sludge age in different UASB reactors as a function of retention time.

<i>System</i>	<i>HRT (hours)</i>	<i>Upflow velocity (m/h)</i>	<i>Average sludge concentration (gVSS*/l)</i>	<i>Average sludge concentration (gTSS/l)</i>	<i>Sludge composition (gVSS/gTSS)</i>	<i>Sludge age (d<sup>-1</sup>)</i>
Pedregal	2.1	1.43	17.0	25.75	0.66	7.8
	2.6	1.15	15.6	22.28	0.70	10.1
	3.0	1.00	17.8	26.18	0.68	14.8
	5.6	0.71	19.6	35.63	0.55	37.5
	7.2	0.56	20.2	36.07	0.56	46.1
	17	0.24	18.1	29.67	0.61	118.2
Cali	4.0 – 8.0	0.5 – 1	25.0 – 30.0	71.45 – 66.66	0.35 – 0.45	30.0 – 150.0
Kanpur	6.0	0.83	25.0 – 35.0	83.33 – 87.50	0.30 – 0.40	50.0 – 70.0
Saõ Paulo	4.0 – 14.0	0.4 – 1.5	2.0 – 8.0	-	-	-

\* VSS: Volatile suspended solids

Source: [Van Haandel et al, 1994]

The sludge mass retained in the UASB reactor can be estimated using sludge concentration profiles determined by real experiences in Colombia, Brazil and India. The average sludge concentrations depend on the sewage composition and operational conditions summarized in table 3.21. The typical average concentration of sludge is about 70 kgTSS/m<sup>3</sup> [Cavalcanti, 2003]. Obviously, the sludge concentration at the bottom of the reactor is high, but decrease steeply with height to very low values.

Production quantities are influenced by retention time. Sludge production was determined under steady state conditions for a single module. The total mass  $P_s$  (kgTSS) was calculated using the method described by Van Haandel & Lettinga:

$$P_s = A_m \sum_{i=1}^l H_s \cdot C \quad (3.55)$$

Where,  $H_s$  is sludge layer depth (m).  $C$  is the sludge concentration (kg/m<sup>3</sup>),  $i$  represents the number of sludge layer. For specific results, in this case, considering one sludge layer, the equation can be rewritten as:

$$P_{TSS} = A_m \cdot H_s \cdot C_{TSS} \quad (3.56)$$

The volume of the sludge blanket was assumed to be 1/3 of the digestion zone volume [Metcalf & Eddy, 2003]. If the total volume from each module is 158.5 m<sup>3</sup>, then the volume of the sludge bed is 52.8 m<sup>3</sup>, and the mass sludge is 3,697.9 kgTSS. The production rate of solids ( $P_{X,TSS}$ ) can be estimated, when the specific sludge production ( $X_{TSS}$ ) and daily organic influent load ( $L_{org}$ ) are known, from:

$$P_{X,TSS} = X_{TSS} \cdot L_{org} \quad (3.57)$$

Where:  $X_{TSS}$  can be assumed to be 0.15 kgTSS/kgCOD [Cavalcanti, 2003] and  $L_{org}$  is 259.07 kgCOD/d for each module, then 38.86 kgTSS/d is obtained.

Since the storage capacity is limited, the sludge must eventually be discharged. It is known that 60% of the total sludge mass can be discharged while 40% is the minimum percentage that must be retained inside the reactor to maintain good performance (COD removal efficiency and operational stability). Also, the sludge could be discharged in the effluent when the effluent is full of sludge, about 2/3 of the sludge production is accumulated inside the reactor and 1/3 is discharged together with the effluent. Then, the real production rate is 25.90 kgTSS/d. Considering these dates, the Solids retention time (SRT) or sludge age can be determined as the ratio between the sludge mass in the reactor and the sludge production rate:

$$SRT = \frac{0.6 \cdot P_{TSS}}{2/3 \cdot (P_{X,TSS})} \quad (3.58)$$

A discharge frequency of 70 days was obtained. For minimal operation cost it is preferable get large dischargings with low frequencies. But, at the same time the dischargings cannot be excessive in order to avoid deterioration of the reactor. Figure 3.8 expresses graphically the period of discharging. The reactor efficiency and operational



stability should be affected only very little during the first few days immediately after the discharge [Cavalcanti, 2003].

Daily COD mass removed ( $P_{X,COD}$ ) can be calculated too as:

$$P_{X,COD} = (E_{COD}/100) / L_{org} \quad (3.59)$$

Table 3.22 reassumes the parameters for the sludge production.

Table 3.22: Average operational conditions of the reactor and average performance parameters for sludge profile.

Parameter		Value	Unit
Sludge layer depth	$H_S$	1.11	m
Typical sludge blanket concentration	$C_{TSS}$	70.00	KgTSS/m <sup>3</sup>
Total sludge mass	$P_{TSS}$	3,697.91	kgTSS
Total solid production rate	$P_{X,TSS}$	25.90	kgTSS/d
Specific sludge production	$X_{TSS}$	0.15	kgTSS/kgCOD
Organic load	$L_{org}$	259.03	kgCOD/d
Sludge age	SRT	70.00	d
Daily COD mass removed	$P_{X,COD}$	165.78	kgCOD/d

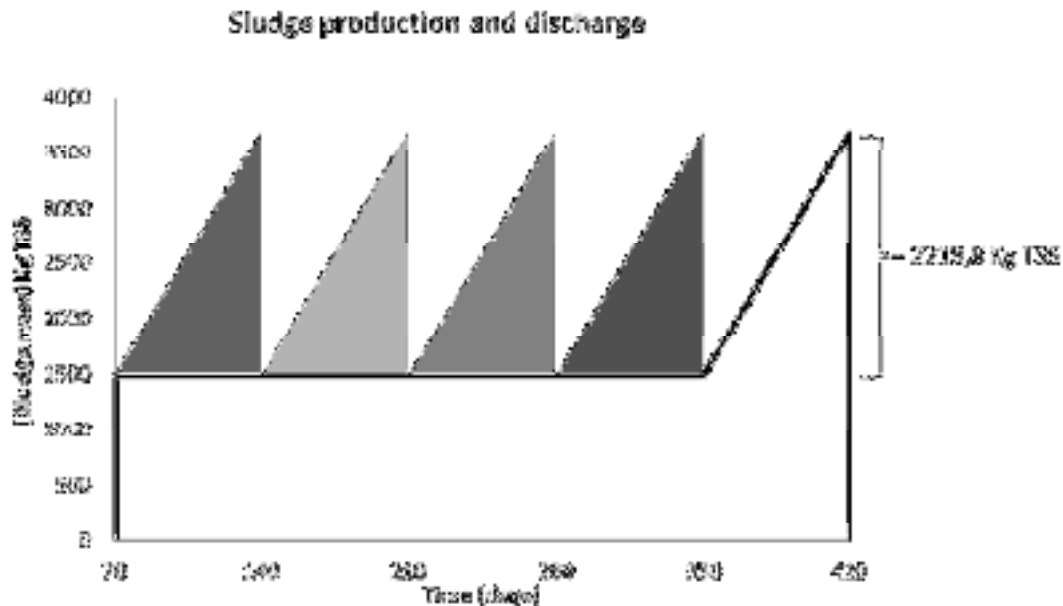

Figure 3.8.: Schematic representation of the sludge mass production and discharge.

### 3.3.2.2. Sludge drying beds

Until now, drying beds are the most widely used method of municipal wastewater sludge dewatering. They have been used for more than 100 years due to their several large facilities in sunny regions, specially low capital cost and energy consumption, no chemicals requirements, less sensitivity to sludge variability and high cake solid content. On the other hand, they require extensive areas; the need of prior sludge stabilizations, potential odor and insect problems and the sludge removal is an intensive labor.

Conventional sand drying beds are the oldest and most commonly used type of drying bed. Physically, they are not differing much from traditional sand filters. In an area confined by trick or concrete bottom and sidewalls, like as a rectangular tank, there is a drainage system composed of perforated pipes at the bottom and it is covered with bottom layers of gravel and top layers of sand. The thickness of sand layer is usually 0.2 m, while gravel layers is about 0.3 m. Total depth of the layer do not be less of 0.5 m [Turovskiy et al, 2006]. This layer allows the percolation of the liquid present in the sludge. Then, a supporting layer would be built with hard burn brick able to withstand the dry-sludge removal operation, elements are arranged with 0.02 – 0.03 m joints, as it is shown in figure 3.9. The supporting layer permits a better distribution of sludge avoiding clogging and dewatered sludge removing. The floor of the drying bed must be even and impermeable, with minimum 1% slope towards the main draining collector.

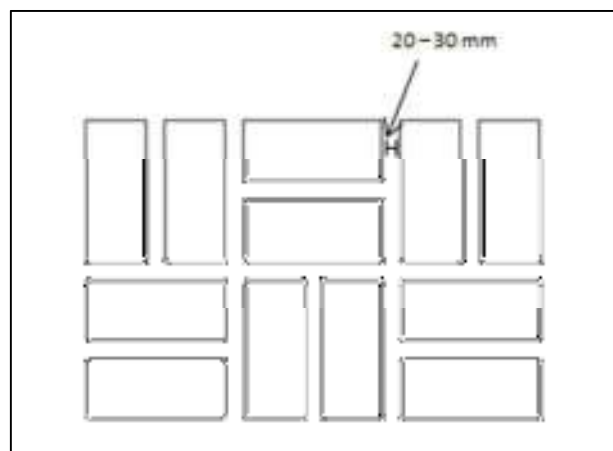

Figure 3.9: Detail of the brick arrangement in the supporting layer.

Usually the number of beds is considerable so that several batches of sludge can be dried simultaneously. Sludge drying beds may be open to the atmosphere or can be constructed with a roof to protect them from rain. By covering the bed it is also possible to use solar energy to heat up the sludge during the drying period and thus to eliminated pathogens. The “solar pasteurization” is particularly important if the sludge is to be used in agriculture [U.S Environmental Protection Agency, 1979].

The evaporation rate depends on several factors such as climate (temperature, humidity, wind, and so on.), the nature of the sludge and the applied solid load on the bed. The sludge of the UASB is generally stable and can be dried in a short period of time, about 15 days.

The solid loading rate (SLR) is a fundamental parameter for the design of a drying bed, it means the ratio between the applied solid mass and the drying bed surface area [Cleverson, 2007]. Brazilian standards recommend a SRL  $\leq 15$  kgTSS/m<sup>2</sup>. Daily 33.3 m<sup>3</sup>/d would be produced of sludge from UASB reactors. Considering 20 days of operational cycle time of drying beds (the time can be varied according to some factors specially the weather), then the total volume of sludge is 666.1 m<sup>3</sup>. In order to dry all of this volume is necessary a drying bed or drying cells with a total extension area of 3,108.4 m<sup>2</sup>. And, the layer of sludge can get in the bed about 0.25 m.

### 3.3.2.3. Sludge utilization

Sludge from biological treatment is constituted by excess biomass with bacterial colonies and suspended, inert and volatile material. At present, extracted solids from San José WWTP are disposed in landfill. Their handling and dumping is relatively easy because they are discharge every five years. The new proposal envisages a post-treatment a subsequence use of sludge. Many alternatives can be the disposal on agriculture or compost. The common applications of wastewater sludge are:

**Beneficial uses:** Sludge may be distributed and marketed for residential or commercial uses as a solid amendment and conditioner. It can be used as a substitute for topsoil and peat on lawns, golf courses, parks, ornamental and vegetable gardens. Usually for this kind of purposes, sludge has been composted. In Chiclayo, there are several NGO's (No governmental organizations) which develop composting activities of wet solids wastes, for example, CENTRO ECO (Chiclayo city) and EMAUS (Lambayeque city). CENTRO ECO develops its activities on the rural zones of Lambayeque district through using organic wastes which are become on organic fertilizer employing on farms or mini farms of poorest families. EMAUS develops its activities working together with the Municipality of Lambayeque and the universities collecting solid and organic wastes and making compost in their pilot plant. One of the proposals of this work is keep the contact with these organizations in order to implement sludge composting programs.

**Land applications:** Emphasizing on agricultural, forest land and disturbed land as a valuable resource improving the characteristics of the land. Sludge is a soil conditioner facilitating nutrient transport, increasing water retention, improving soil structure, and replacing expensive chemical fertilizers. But, at the same time, the agricultural use of sludge needs a very special attention. Most bacteria, virus, protozoan cysts and intestinal parasite eggs are not completely inactivated. Other more complex methods are absolutely necessary for this goal. Even conventional stabilization processes, such as aerobic or anaerobic digestions, needs a complementary stage to achieve a complete disinfection. Still, sludge has a high content of organic matter and nutrients, and it can be applied as a bio-fertilizer to increase the land quality. Peruvian law about sewage sludge applications permits their agricultural use as long as they meet the legal requirements including those that can be set in the future (low content of heavy metals and organic contaminants).

**Other methods of final disposition:** Solids and bio-solids removed from preliminary and biological treatment processes can be concentrated and stabilized by biological or

thermo-chemical processes in order to prepared and reduce volume for their final disposition. It can also be transported long distances with close container so as to minimize the risks of odours and dissemination of pathogens to the air. Methods of final disposal include landfilling and lagooning. Sanitary landfill is the most suitable; the wastes are deposited in a designated area, compacted and covered with a 0.3 m layer of clean soil. Lagooning is a simple and economic method if the WWTP is in a remote location, where the sludge is stabilized through anaerobic and aerobic decomposition. Lagoons should be located away from highways and dwelling to minimize possible nuisance conditions.

A more beneficial use of sludge is energy recovery and application. In fact, some studies on domestic sewage sludge have shown that sludge represents a residue with a high energy content even achieving values of about 24.5 MJ/kg [Ginoris et al., 2010]. For this yield, gasification is considered as one of the most efficient thermochemical processes to convert biomass into energy. Fuel from conversion of sewage sludge dried through gasification processes can be used in conventional thermal engines, such as combustion motors or turbines. Gasification processes present many advantages such as, for example, the complete sterilization of sludge, and a significant reduction in volume with ash production. However, sludge needs a drying pre-treatment process due to its high moisture content (85%) [Coronella et al, 2010].

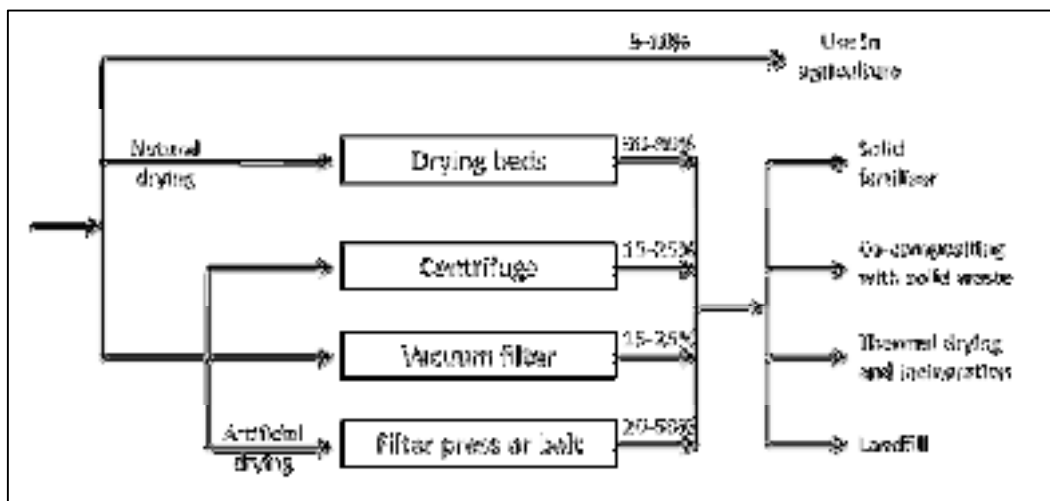

Figure 3.10: Methods of treatment and final disposal.

### 3.3.3. Biogas treatment

One of the advantages of the UASB is the potential of biogas recovery. It represents a good resource for future applications. Some research studies and real applications demonstrate that the biogas can be treated by power generators for electricity production. Furthermore, heat can be transmitted to the reactors to maintain the internal temperature. The electricity produced is useful for room lighting and operating electrical equipment, such as screens. On the contrary, possible losses of methane have two negative effects: energy is lost and CH<sub>4</sub> is a potent greenhouse gas if it is released to the atmosphere [Grosso, 2010].

### 3.3.3.1. Biogas production

The amount of methane produced depends on the concentration COD influent and the methane production rate ( $P_{CH_4}$ ) at the internal temperature of the reactor (35°C) considered to be equal to 0.4 m<sup>3</sup>/kgCOD [Metcalf & Eddy, 2003]:

$$Q_{CH_4} = P_{CH_4} \cdot COD_{mb} \quad (3.60)$$

Where  $COD_{mb}$  is the amount of COD used by methanogenic bacteria, which is dependent on the total flow rate of the plant, and was calculated in this case study to be equal to 593.4 kgCOD/h.

Now, the plant can produce 212.3 m<sup>3</sup>/h of CH<sub>4</sub>.

However, in the UASB, some methane losses do occur, and not all the methane produced is useful for energy recovery. Table 3.24 reports the methane losses in a UASB according to Grosso, et al., 2010.

Now, the real CH<sub>4</sub> available for energy recovery was calculated using the following equation:

$$Q_{CH_4-CR} = Q_{CH_4} \cdot (1 - p_w - p_o) - \frac{Q_t \cdot p_L \cdot f_{CH_4}}{f(T)} \quad (3.61)$$

Where:  $f_{CH_4}$  is the conversion factor from methane to COD (4 kgCOD/kgCH<sub>4</sub>) and  $f(T)$  is a correction factor calculated as a function of the operating temperature:

$$f(T) = \frac{P \cdot W_{COD}}{R \cdot (273 + T)} \quad (3.62)$$

Table 3.23: Percentage of methane losses in a UASB reactor

Type of losses	Unit	Minimum value	Medium value	Maximum value
Loss as residual gas ( $p_w$ )	%	2.5	5.0	7.5
Other losses ( $p_o$ )	%	2.5	5.0	7.5
Effluent leaks ( $p_L$ )	kg/m <sup>3</sup>	0.015	0.02	0.025

Source: [Grosso et al, 2010]

With  $P = 1 \text{ atm}$ ;  $W_{COD} = 32 \text{ kgCOD/molCH}_4$ ;  $R = 0.082 \times 10^{-3} \frac{\text{atm.m}^3}{\text{mol.K}}$ ; and  $T = 35^\circ\text{C}$ . In this way,  $Q_{CH_4-CR}$  results as 190.8 m<sup>3</sup>/h, and the total biogas flow results as 293.6 m<sup>3</sup>/h.

### 3.3.3.2. Desulphurization

The biogas composition can be very varied. Taking into account the typical composition of biogas as proposed by Metcalf & Eddy, 2003, biogas has following composition 65%, 25%, 3.8%, 2.2%, 2.5%, 0.5%, 0.5% and 0.5% for CH<sub>4</sub>, CO<sub>2</sub>, H<sub>2</sub>S, N<sub>2</sub>, H<sub>2</sub>O, NH<sub>3</sub>, H<sub>2</sub>, and O<sub>2</sub>, respectively. H<sub>2</sub>S, (even in small concentrations) is particularly harmful when biogas is used in internal combustion engines. Its chemical reaction and those of its combustion products, SO<sub>2</sub>, quickly lead to severe corrosion and wear on engines. H<sub>2</sub>S can be removed by the dry desulphurization using ferrous substances. Iron-containing soil is suitable for use as the purifying agent in developing countries [Montalvo et al, 2003].

This method based on the absorption has large application due their high efficiency and relative low cost. The most system used is with iron filling [Osorio et al, 2009]. Ferrogenuous soils containing large concentrations of hydrates ferric oxides, goethite, lepidocrocite and limonite. The iron content is usually around 40 - 50% by weight. Some absorbents are to be activated before use and they are regenerated again before they can really carry out the purification process.

#### The desulphurising apparatus and process.

It is a tall chamber, the size is important. If is too small, the gas will flow too quickly through the absorbent and the contact time is too short. If the gas flow is too fast, channels will open in the absorbent. The purification chamber contains several intermediate trays. A layer of absorbent 0.2 - 0.5 m is placed on each tray. The intermediate trays are permeable to biogas. They are made from perforated steel sheet or wooden slots. Intermediate trays do not rest upon the absorbent in the tray below, but they are supported by small spacers attached to the tray underneath. The absorbent should be placed on the trays in such a way that it is not compressed or packed down.

The chamber cover should be designed to give access to the whole chamber cross section. This allows the removal of the intermediate trays from the chamber. Control valves are installed in the feed and exit pipes of the purification chamber. These are used to disconnect the chamber when the absorbent is being exchanged. A scavenging vent has to be installed too. It would be used for flushing air out of the chamber with biogas after exchanging the absorbent and sealing the chamber. Moreover, a vent exit should be installed high up and away from buildings. The H<sub>2</sub>S content in the gas can also be checked via the scavenging vent even during the plant operation.

The chamber could have the following dimensions: 14.00 m depth, 0.76 m radius, so 1.81 m<sup>2</sup> cross sectional area. The flow rate of the H<sub>2</sub>S is about 11.2 m<sup>3</sup>/h with 15.0 kg/h mass flow rate. The gas velocity through the chamber is must be less 0.05 m/s. Contact time is very important, not less than 0.05 h (3.0 minutes), in fact, according to our calculations, the contact time is about 0.087 h (5.2 minutes). The chamber has a total volume of 25.7 m<sup>3</sup>. The distance between every tray is 0.5 m, while the width of single tray is 0.36 m. Each operation cycle is considered every 60 days, which represent the operating time desired between absorbent exchanged. During 60 days about 21,600 kg H<sub>2</sub>S

can be generated and removed. The follow figure illustrates some aspects of the desulphurising apparatus designed.

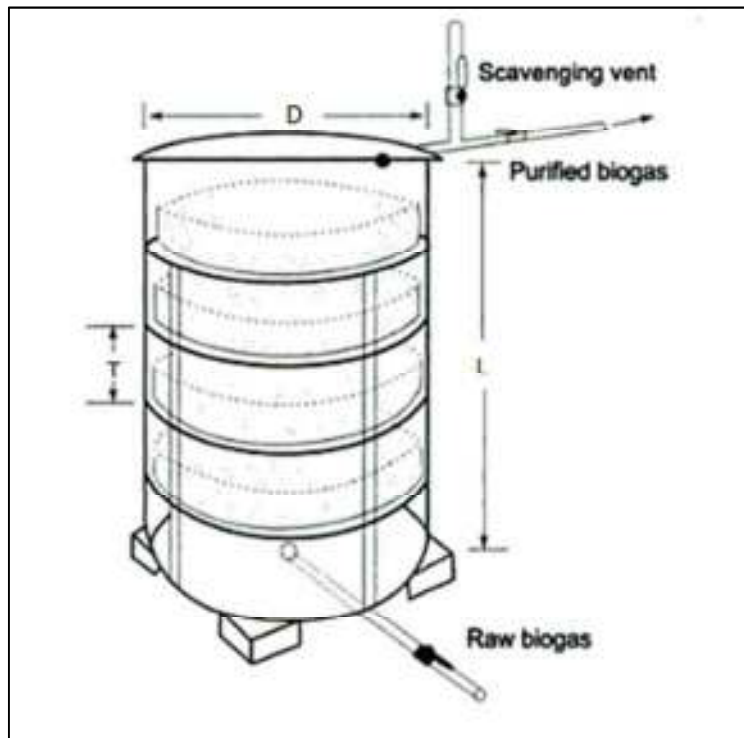

Figure 3.11: Cylindrical desulphurization chamber for biogas  
(D = diameter; L = Length; T = distance between trays.  
Source: [Nijagua, 2002]

This process can operate from ambient pressure to several hundred kPa, getting good H<sub>2</sub>S removal efficiencies at ambient temperatures or higher. The moisture content of the fillings should be between 30 and 60%. A pH operation ranging from 7.5 to 8.5 is the best. The fillings can be regenerated until three times. Times, depending on the amount of sulfur removed the appropriate temperature, pH and moisture content. The construction of two chambers is recommended, one of them would be operating, while the other one is for reserved. The chambers are also placed in series – two or more - and making pass the biogas through mixing chambers in series one after the other. The first one can be useful as coarse purification while the second one can be useful as fine purification [Nijagua, 2002].

Final concentration of H<sub>2</sub>S is usually 0.3% volume. In fact, after some calculations, the final biogas flow rate was estimated to be about 282 m<sup>3</sup>/h in the following concentrations: 67.3%, 25.9%, 2.3%, 2.6%, 0.39% 0.5%, 0.5% and 0.5% for CH<sub>4</sub>, CO<sub>2</sub>, N<sub>2</sub>, H<sub>2</sub>O, H<sub>2</sub>S, NH<sub>3</sub>, H<sub>2</sub>, and O<sub>2</sub>, respectively.

### 3.3.3.3. Energy production and utilization

In order to know the energy potential of biogas, Low Heating Value (LHV) is important. Considering biogas as a mixture of gases, LHV was calculated and it was about 21 MJ/m<sup>3</sup>. According to some research, biogas from UASB reactor treating low strength

sewage can be varied from 18 to 27 MJ/m<sup>3</sup> [Metcalf & Eddy, 2003]. Then, the energy production can be calculated through:

$$E_{biogas} = (Q_{biogas} \times \lambda_{biogas}) \quad (3.63)$$

Where,  $E_{biogas}$  is the energy produced measured in MW,  $Q_{biogas}$  is the flow rate useful to energy production, and  $\lambda_{biogas}$  is the LHV of biogas. But assuming an engine conversion efficiency of 25% [Elias, 2005], then the final useful energy production is approximately 0.42 MW.

The energy produced will be useful for the self-efficiency of plant, some installations need energy supply, for example entrance control, toolroom, repair shop, offices, toilets and wardrobe, and so on. The rest can be selling to the National Electricity grid in order to meet the external energy demands. Table 3.24 shows the results for biogas production and energy generation.

Table 3.24: Biogas and energy production.

<i>Parameters</i>		<i>Units</i>	<i>Value</i>
Total flow rate of biogas	$Q_{biogas}$	m <sup>3</sup> /h	282.00
Total flow rate of methane	$Q_{CH_4}$	m <sup>3</sup> /h	190.00
Methane content	-	%	67.30
Biogas Low heating value	$\lambda_{biogas}$	MJ/m <sup>3</sup>	21.00
Energy produced	$E_{biogas}$	MW	1.64
Performance engine	-	%	25.00

Biogas is an excellent fuel for a large number of applications. Biogas can be used in all natural gas applications. Three basic ways of biogas utilization are heat production, electricity generation and motors fuel. Worldwide, biogas is mainly applied on combine heat and power applications (CHP). Although gas turbines could be used with low emissions, the efficiencies can be comparable to spark-ignition engines and low maintenance; in addition, the investments are on the high side. Mostly internal combustion engines are used in CHP applications, either as spark-ignition or dual fuel engines. Applications such as motors fuel are suitable because it can be useful as an alternative to natural gas (NGVs). Today, several manufacturers offer a big range of vehicles models (light and heavy) using biogas instead of natural gas due to CO<sub>2</sub> emissions can be reduced significantly.

### 3.3.4. Final discharge of sewage

Thanks to the final effluent characteristics, sewage can be discharged into the water bodies, in this case, the sea of San José's little fishing harbour (Pacific Ocean), which is the main employment source of local citizens and their seafood products are sell in local and regional markets. Also, the agricultural land near to the plant would be irrigated. Employing this proposal the sewage treated keep the standards irrigation of agricultural lands with municipal WWTP effluents established by Peruvian and Pan-American laws



established by Peruvian government, PAHO<sup>31</sup> and CEPIS. At the moment, the authorities are not taking corrective measures to control the discharge of effluents in the agriculture.

Sewage treated are reusing for non-potable applications. Agricultural and urban uses have environmental and economic advantages. In fact, it represents one of the main solutions for water scarcity, and it becomes a valuable water source in countries of arid and semi-arid regions (Meneses M, et al. 2010). The common applications are:

**Agricultural applications:** The presence of nutrients in treated municipal wastewater provides fertilizer value for irrigation of crop. Nutrients occurring in important quantities include nitrogen and phosphorus and occasionally potassium, zinc, boron, and sulfur. But it is important the control and monitoring because the excess can cause problems related to excessive vegetative growth, delayed or uneven maturity, or reduction of the quality due to imbalanced nutrients supply [Pedrero et al, 2010]. Treated wastewater in the agriculture has gained importance in water-scare regions. It is an ancient practice in cities as Berlin, London, Milan and Paris. In Mexico about 260.000 ha are irrigated with wastewater, mostly untreated [Pedrero et al, 2010]. From 70's years, Israel applies wastewater for cotton and crops irrigation. 80% of the wastewater treated are using for agricultural irrigation. There are 200 reservoirs for wastewater storage and several new projects are implementing. In developing countries the practice is applying recently. In Pakistan 26% of national vegetable production is irrigated with wastewater [Pedrero et al, 2010]. Peru produced yearly 134.7 million m<sup>3</sup> of domestic wastewater of which 99.9 million m<sup>3</sup> received treatment and, 18.6 million m<sup>3</sup> was used for irrigated crop areas, it means 0.15% of total irrigated area is irrigated with treated wastewater [FAOSTAT, 2004]; crops irrigated with wastewater are corn, cotton, alfalfa, plane tree, sugar cane and some vegetables.

While in developed countries, their programs include policies about the management of wastewater in order to safeguard the human health; in developing countries, farmers irrigate with diluted or partly treated wastewater and they and their families are exposed to health risks.

**Urban applications:** Urban application includes the irrigation of parks, playgrounds, golf courses, freeway medians, landscape area around commercial, office and industrial developments, and landscape areas around residences. The quantity and quality of available wastewater may be more consistent compared to freshwater, with adequate treatment, wastewater can meet specific needs and purposes, such as toilet flushing in business or commercial premises, car washing, garden watering, park or other open space planting, and firefighting. In urban areas, the potential of introducing wastewater reuse is quite high and reuse options may play a significant role about controlling wastewater utilization.

**Industrial applications:** Industrial applications include high rates of water consumption in power plants, pulp and paper industries and so on. Many industries treat their sewage providing adequate water quality through additional treatment processes. In

---

<sup>31</sup> PAHO is the acronym for Pan American Health Organization.

some cases, closed-loop recycle systems have been developed that treat water from a single process stream and recycle the water back to the same process with some make up water. In other cases, municipal sewage treated are using directly for industrial purposes such as in cooling towers. Other non-potable urban uses can be fire protection, air conditioning and toilet flushing.

**Discharges on the sea and fish farming:** Discharges on the sea could be an advantage. It means less polluted beaches, recreational and tourist attractive and increase of incomes for the region. Moreover, the amount of nutrients, nitrogen and phosphorous is more than adequate for the grown of algae and phytoplankton (obviously not in the neighboring of the discharge pipes). In fact, the organic material provides basic nutrients alternatives to the food chain which is independent of the photosynthesis in depth sea areas limited of the sun light.

Regarding fish farming, there are several experiences around the world, which demonstrated the increasing of fish production employing wastewater in ponds. Those effluents were treated and diluted with river waters or partially clarified. The main element is the organic matter and the natural food development in fishing pond is the base for the fish production. Once the sewage is pass through the ponds and the organic matter is used, the sewage can use for irrigation. The high salt concentrations can be a problem for the agricultural irrigation, but there are some fish species that can be adapted to the salt high levels. The dissolved oxygen levels in ponds is very high, then, fish feed on plankton that grows in abundance in wastewater, given its eutrophic characteristics.

### 3.4. Discussion

Anaerobic digesters are being largely used for the treatment of solid wastes, agricultural wastes, animal excrements, sludge from sewage treatment plants and urban liquid wastes, as well as, for effluents from agricultural, food and beverage industries, both in developed and developing countries [De Lemos, 2007].

Anaerobic sewage treatment systems, especially Up-flow anaerobic sludge blanket (UASB) reactors, have grown in maturity especially in several tropical countries due to mainly their favorable temperature conditions. In fact, UASB reactors are having a substantial increment on the treatment of domestic sewage in warm-climate regions, where the efficiency of the process depends much more on the temperature of sewage, because the activity of anaerobic microorganisms at temperatures below 20°C is low and it is not feasible heating the reactors. In this way, the anaerobic technology is more attractive for tropical and subtropical climates countries which are mainly developing countries.

This chapter describes three lines of treatment (sewage, biogas and sludge treatment) and compares current efficiencies with those calculated for the new scheme proposed. Current removal efficiencies are of approximately 65% BOD<sub>5</sub> and 90% Faecal Coliforms. Applying 5 UASB reactors with 18 modules each; each reactor has a treatment capacity of 2,852 m<sup>3</sup>/h, a 3,360 m<sup>3</sup> volume and 6 hour Hydraulic Retention Time. The reactor presents removal efficiencies of approximately 71%; 64%; 90% for BOD<sub>5</sub>, COD and Faecal Coliform,

respectively; while the entire system proposed (UASB and ponds) can achieve removal efficiencies of about 91%, 64% and 99.9% for BOD<sub>5</sub>, COD and Faecal Coliform, respectively.

When an efficient anaerobic treatment previous to discharge the sewage into a ponds was applied, organic matter and suspended solids are largely removed, subsequently, only a complementary removal is necessary, but removal of pathogenic organisms will be required, and for this reason, when stabilization ponds are intended for post-treatment of effluents from anaerobic digestion, they are called “polishing ponds”. This system is common in developing countries.

The UASB and polishing ponds configuration is a very interesting alternative from the technical, economic and environmental points of view. Some advantages can be related to the problems about the odours from anaerobic ponds can be avoided utilizing UASB reactors since the reactor can be installed with odour control, moreover this alternative is even more attractive when the effluent from the ponds can be used for agricultural purposes, since the polishing ponds aim mainly at the removal of pathogenic organisms, in fact, in some developing countries, especially in agricultural regions, treated effluents are being using for irrigation of high-stalk plants, crops for example.

So, It was demonstrate that final effluents have the appropriate characteristics for recycling, compliant with the requirements of Peruvian law for waste treatment and disposal.

Due to its high methane content, biogas has a LHV equivalent to 21 MJ/m<sup>3</sup>. The amount of energy generated is potentially 0.42 MW and this could satisfy the plant’s energy demands.

This chapter can conclude that it is feasible to implement UASB reactors in San José WWTP taking into account the structural, social, economic and environmental advantages they provide, most importantly in terms of human health. An preliminary study about environmental impact assessment and economic consideration are discussed in annex 2.

The present proposal is an optimum starting point for future applications regarding biogas and sludge recovered as will be discuss in the following chapters. These elements represent important resources for energy applications, especially yields from biomass recovery can constitute a considerable energy source for developing countries in Latin America.

## **CHAPTER 4: PRE-TREATMENT OF SEWAGE SLUDGE: FOCUS ON DIFFUSION MOISTURE COEFFICIENT CALCULATION.**

As previously said, sludge is a bio-solid residual from the wastewater treatment process. Considering the utilization of the wastes of the process, the energy valorization of sewage sludge is an important point of attention in this research and needs an especial consideration.

In Italy and the European Union (EU) there are diverse current regulations about the treatment and disposal of the sewage sludge from diverse kinds of sewage treatment plants. The Italian current regulation is include on the D.Lgs. 152/06 where there are determined the methods of disposal and uses [ISPRA<sup>32</sup>]:

- Disposal on landfill,
- Uses on the agriculture under composted way,
- Alone incineration or co-incineration with wastes,
- Bricks, asphalt and concrete industries applications.

They are usually disposed on landfill, but due to the growth and increasing of the treatment plants, laws forces to pay more attention to all the reuse possibilities and use of new technologies for their treatment.

Currently in Peru, there are not regulations about treatment and final disposal for sewage sludge, they are considered as residual from especial activities or installation and almost 100% of sludge generated in treatment plants are disposed in landfills. Unfortunately, data about sludge production and its utilization is not documented nor update.

According to many researches, sewage sludge has a high content of organic matter and nutrients, so, it can be helpful for agricultural applications and improving soil structure. However, the toxic compounds and heavy metals present in the sludge limit their reuse because represent a risk for human health and the environment.

Nevertheless, sewage sludge is also considered a renewable energy source for fuel power applications with greenhouses gas emissions reduction. Sludge is being study through some conversion processes (combustion, pyrolysis or gasification) in order to get energy. But, sludge is a material with very high moisture content, then, for its effective applications, moisture content needs to be less than 30%. In this sense, once sludge is obtained from sewage treatments processes, an extensive drying as pretreatment is required.

Thus, the present chapter is mainly focused on the study of the evaluation of thermal drying of sewage sludge and diffusion moisture coefficient in slab geometry through experimental and numerical simulation activities carried out at the laboratories of Chemical and Materials Engineering Department from the University of Nevada, Reno, where the author of this thesis was a research scholar for a period of six months.

---

<sup>32</sup> ISPRA is the Italian acronym for Istituto Superiore per la Protezione e la Ricerca Ambientale.

## **4.1. Experimental procedure**

Samples were prepared with dewatered sludge obtained from Truckee Meadows Water Reclamation Facility (TMWRF) in Sparks city on the Nevada State. TMWRF is a biological nutrient removal plant that uses separate nitrification and denitrification processes for nitrogen removal and biological and chemical processes for phosphorus removal. Sewage sludge presents a moisture content about 85% on wet basis. The sludge was kept in poly-ethylene bags and stored in a refrigerator at about 5°C until their use in the experiments. Two VWR vacuum ovens were used. For the drying process, the samples were introduced in the oven at constant temperature of 50°C; and for moisture testing, the samples were dried for at least 24 hours at 105°C.

From the bulk sample, 24 samples were prepared, with approximately 6.5 g pipeted into 1.5 ml centrifuge tubes (12 cm depth and 1.6 cm diameter) for each sample. The sludge sample depth was about 6.0 cm.

### **4.1.1. Sterilization process.**

In order to avoid methane formation and hence pull the sample, a sterilization process has been necessary. For the sterilization process, 3 more samples were prepared. A 1L Pyrex container was used, containing hot water at about 80°C with an agitator at the bottom. The centrifuge tubes with sludge were submerged so that the sludge was 9 cm under the level of the water. The sterilization process was about 65 minutes. Sterilization processing was repeated many times even after drying experiment.

The moisture and concentration presented little variation with respect to initial moisture and concentrations.

### **4.1.2. Drying process.**

After sterilization, the 24 samples were introduced into a constant temperature 50°C oven, keeping a constant relative humidity using LiCl (11.8%). For those samples, 3 groups were done, 8 tubes for each group, so that 3 tests for each condition were performed to get more accurate results. The drying procedure was as follows: 1) One tube from each group was taken every 12 hours; 2) the tubes were cut in 4 pieces, each one of 1.5 cm depth; 3) the whole little sample for each piece was extracted and weighed. It was considered that each little sample represented a layer to analyze. Once, the weight was measured, the samples were dried for at least 24 hours at 105°C. The dry sludge was weighed again in order to determine the moisture content. Moisture content was the average value for every layer.

The experiment was 8 days long. For the first 4 days, the tests were taken every 12 hours, then, another test was performed on the 6th day, and the last test was on the 8th day.

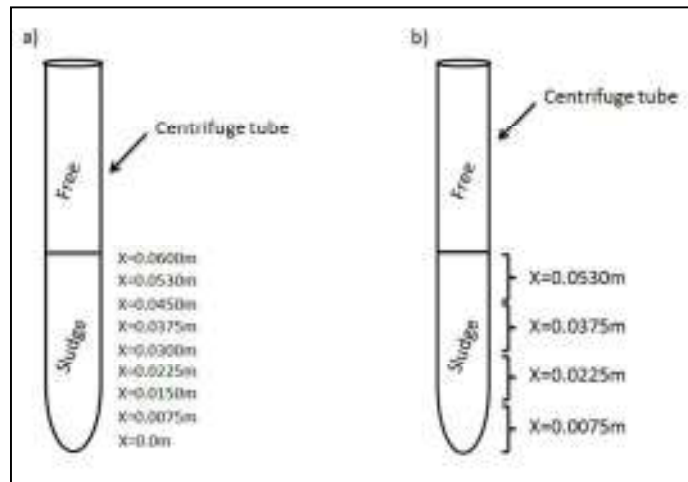

Figure 4.1: Scheme of layer analyzed: a) Number of layers considered for the simulation and optimization process. b) Number of layers considered for the experimental procedure.



Figure 4.2: Picture describing the sterilization process.



Figure 4.3: Picture describing the drying process.

## 4.2. Mathematical approach

### 4.2.1. Drying process of layer symmetry

A Fick's law model was applied:

$$D_{eff} \frac{\partial^2 M}{\partial x^2} = \frac{\partial M}{\partial t} \quad (4.1)$$

Where  $M$  is moisture content (kg water/kg dry solid), and  $D_{eff}$  ( $m^2/s$ ) is the effective diffusivity of concentration inside the solid. A non-constant diffusivity was assumed, then, the equation 4.1 becomes as follow:

$$\frac{\partial(D_{eff} \frac{\partial M}{\partial x})}{\partial x} = \frac{\partial M}{\partial t} \quad (4.2)$$

Numerical integration was done considering the elements and layers presented in figure 4.4 and has been done in accordance with the discretized expressions from Fick's law of diffusion for calculating  $M$  at time  $t + \Delta t$  from the data of  $M$  at time  $t$ , for each interval of solids sample  $\Delta x$ , which may depend on the temperature and also on the local moisture content [Font, et al. 2012].

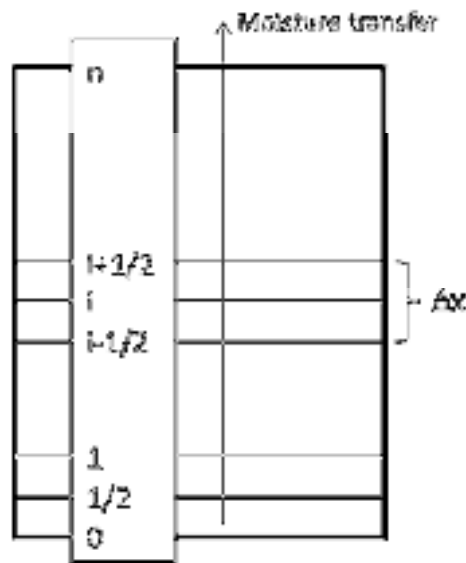

Figure 4.4: Layer considered in the plane symmetry.

The discretization process of mass balance was done as follow:

For the intermediate element:

The mass fluxes were calculated from the effective diffusivity at the local compositions taking account the moisture content and the density, thus  $\eta_{i+1/2}$  ;  $\eta_{i-1/2}$  (kg/m<sup>2</sup>s) are given by:

$$\eta_{i+1/2} = -\rho \cdot D_{eff} \left[ \frac{M_{i+1} - M_i}{\Delta x} \right] \quad (4.3)$$

$$\eta_{i-1/2} = -\rho \cdot D_{eff} \left[ \frac{M_i - M_{i-1}}{\Delta x} \right] \quad (4.4)$$

Where  $M_i$  refers to the moisture content in the interval "i",  $M_{i+1}$  refers to the moisture content in the successive interval and  $M_{i-1}$  in the precedent interval. Then, the rate of mass accumulation is given by:

$$\eta_{i+1/2} - \eta_{i-1/2} = \rho \frac{\partial \Delta x M_i}{\partial t}$$

Thus, it results:

$$-D_{eff} \left[ \frac{M_i - M_{i-1}}{\Delta x} \right] + D_{eff} \left[ \frac{M_{i+1} - M_i}{\Delta x} \right] = \frac{\partial \Delta x M_i}{\partial t} \quad (4.5)$$

The discretized expression on the time is:

$$t = p\Delta t$$

$$M_i^{p+1} = M_i^p + \frac{\Delta t}{\Delta x} \left[ -D_{eff}^p \left[ \frac{M_i^p - M_{i-1}^p}{\Delta x} \right] + D_{eff}^p \left[ \frac{M_{i+1}^p - M_i^p}{\Delta x} \right] \right] \quad (4.6)$$

Where  $M_i^{p+1}$  refers to the moisture content in the interval "i" at time  $t + \Delta t$ , and  $M_i^p$  at time  $t$ .

Boundary conditions:

For the inner element ( $i=0$ ):

$$M_0^{p+1} = M_0^p + \frac{2D_{eff,1/2}^p \Delta t}{\Delta x^2} (M_i^p - M_0^p) \quad (4.7)$$

Where  $M_0$  is the initial moisture content (kg/m<sup>3</sup>)

For the outer element ( $i=n$ ):

According to first simulation carried out on MathCAD Engineering Calculations Software, the moisture content is immediately constant for the surface layer. Then, the boundary condition at the outer element is the equilibrium moisture.

For  $t = 0$ :

The moisture contents have been measured after sterilization process. Bacteria activity gave some problems with the first trials of the experiments, then, the interruption of the methanogenic activity was necessary for a good drying process performance. Just only for



MathCAD simulation, the moisture at time zero was considered constant for each  $x$  position analyzed, the successive simulation were done with experimental values after sterilization process.

*Diffusion coefficient:*

$D_{\text{eff}}$  is the effective moisture diffusivity and two situations were analyzed in this work, when diffusion coefficient is considered constant and when it is considered not constant. A mathematical model proposed by Font, et al was applied for this work in the case of diffusivity varies with moisture content:

$$\rho_s D_{\text{eff}} [kg/m s] = \left(0.140 - 0.0946 \frac{M}{M_0}\right) \exp\left(-\frac{3,425}{T}\right) \quad (4.8)$$

Where  $M$  is the local moisture content,  $M_0$  (kg water/kg d.s.) is the initial moisture content,  $\rho_s$  is the density of dewatered sludge (kg/m<sup>3</sup>), 3,425 (K) is the activation energy for the internal water transfer,  $T$  (K) is the temperature of the drying process; and 0.140 and 0.0946 are the correlation parameters for this equation proposed by the author.

For a more useful way, equation 4.8 is rewritten, where the correlations parameters become unknown parameters, thus it is given by:

$$D_{\text{eff} i-1/2}^P = \frac{\left(\alpha - \beta \frac{M_{i-1/2}}{M_0}\right) \exp\left(-\frac{3,425}{T}\right)}{\rho_s} \quad (4.9)$$

$$D_{\text{eff} i+1/2}^P = \frac{\left(\alpha - \beta \frac{M_{i+1/2}}{M_0}\right) \exp\left(-\frac{3,425}{T}\right)}{\rho_s} \quad (4.10)$$

Where

$$M_{i-1/2} = (M_i + M_{i-1})/2 \quad (4.11)$$

$$M_{i+1/2} = (M_i + M_{i+1})/2 \quad (4.12)$$

The density of the dewatered sludge samples is about 1,050 - 1,080 kg/m<sup>3</sup> [Von Sperling 2007].

#### 4.2.2. Procedure for optimization process

In order to find the best values for  $\alpha$  and  $\beta$ , an optimization process has been implemented applying the following mathematical expressions:

- $\Gamma_{ij} = M(x_i, t_i)$  Represents the measured moisture values obtained experimentally.
- $M(x_i, t_i, \alpha, \beta)$  Represents the calculated moisture content through finite difference expressions for the inner and intermediate layers.
- The optimization process was the minimizing the objective function defines by the sum of the square of the difference between experimental and calculated moistures contents, and can be written as:

$$e_{ij}(\alpha, \beta) = \left( \Gamma_{ij} - M(x_i, t_i, \alpha, \beta) \right)^2 \quad (4.13)$$

d) Then, the total objective function is expressed as:

$$E(\alpha, \beta) = \sum_{i=1}^N e_{ij}(\alpha, \beta) \quad (4.14)$$

Where N represent the total samples.

e) Many iterations were performed until the smallest value of the objective function was obtained.

f) The mean error between experimental and calculated data was calculated as:

$$Error = \frac{1}{N} \sum_{i=1}^N \frac{|M(x_i, t_i, \alpha, \beta) - \Gamma_{ij}|}{\Gamma_{ij}} \quad (4.15)$$

An accurate modeling of the drying behavior of different products requires specific regression and correlations statistical models in order to achieve a set of equations which allow a proper description of the system [Celma A.R. et al, 2012]. In this work, many trials and attempts were carried out in order to determinate a simplified model which better describes the correlations data for these experimental data.

### 4.2.3. Equilibrium Moisture Content (EMC) models

Moisture content affects the drying conditions and energy requirements for biological material processing, thus, the moisture interaction and equilibrium properties is of great interest for drying processes [Coronella, 2009] and other many engineering applications. Like EMC is a function of water activity, many models have been proposed in the literature in order to describe the evolution of the equilibrium moisture content with water activity.

The EMC of biosolids depends on the relative humidity, temperature of the environment and physical characteristics of the material. EMC increased with increasing relative humidity for any temperatures and decreases with increase in temperature at constant relative humidity.

For this specific case of domestic sludge, a model developed by Vasquez and Coronella (VCSM model) is helpful. This model describes equilibrium moisture in heterogeneous biomass substrate. Other typical model used to fit the equilibrium moisture data as function of temperature and relative humidity is a Modified Halsey model presented by Bellur [Bellur, S et al, 2009 and Vaxelaire, 2001]:

$$EMC = \left( \frac{\exp(a-b \cdot T)}{-\ln(Hr)} \right)^{\frac{1}{c}} \quad (4.16)$$

With  $a=-3.899$ ;  $b=0.032$ ;  $c=2.83$ , T is temperature in °C and Hr is relative humidity.

According to this model, the EMC with about 11.8% relative humidity is about 0.12 kg water/kg d.s. Bellur presents some experimental data and compares with VCSM model and Modified Halsey model according to the figure 4.5.

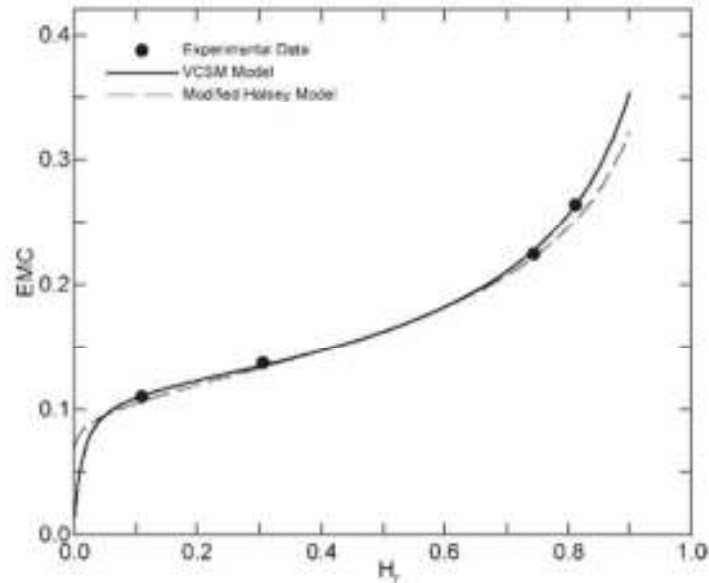

Figure 4.5: Bellur's experimental data, Modified Halsey model and VCSM model predicted equilibrium moisture data for biosolids at 50°C reported by Bellur, 2009.

### 4.3. Experimental results

Changes in the moisture for each interval of position with time during the drying process of sewage sludge have been compared and media values have been taken and showing in the figures 4.6 and 4.7. The values for initial time were taken from sterilization experiment results; and values for the last position (when  $x=0.06$  m) were taken as equilibrium moisture, tested with simulation results.

The moisture is decreasing with time, but the evolution of moisture content is not constant. The drying time is long due to the characteristics of the experiment. It is note that the moisture content for the layers near to the bottom of the tube is not presenting significant changes even with high periods of times. While, for layers near to the surface (where the contact with the atmosphere is direct) presents significant changes on the moisture. The changes are remarkable for the second to last layer (closer to the surface) analyzed during the experimentation, a more constant moisture content decreasing was observed for the layer analyzed at the surface. The curve represents the last position which is constant due to the equilibrium moisture assumed for the surface particles.

The variation of the time was constant for the first part of the experiment of 12 hours, while for the last two measurements the period of time was 48 hours.

It was observed the variation of solid moisture for the differences particles of the slab geometry with same operation conditions, the results present that the moisture profiles at high values of time is steeper as with short values of time. These curves have been tested through simulation activities.

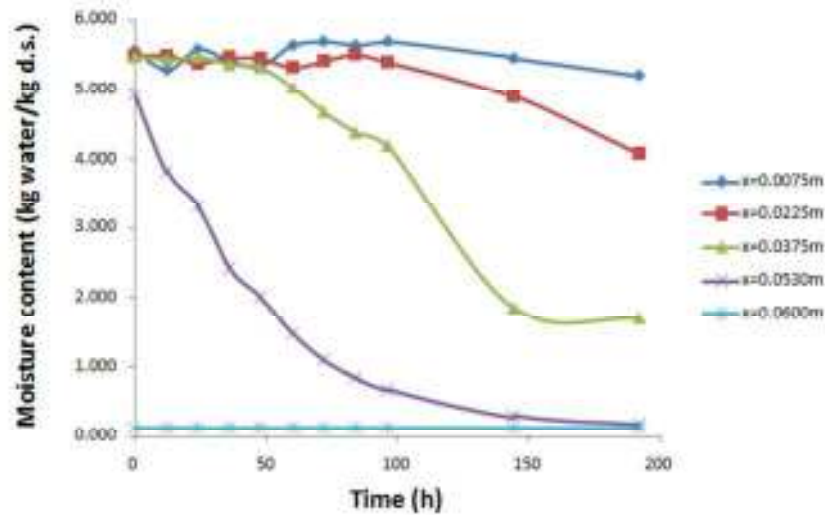

Figure 4.6: Variation of Moisture content (kg water/kg d.s.) vs. time.

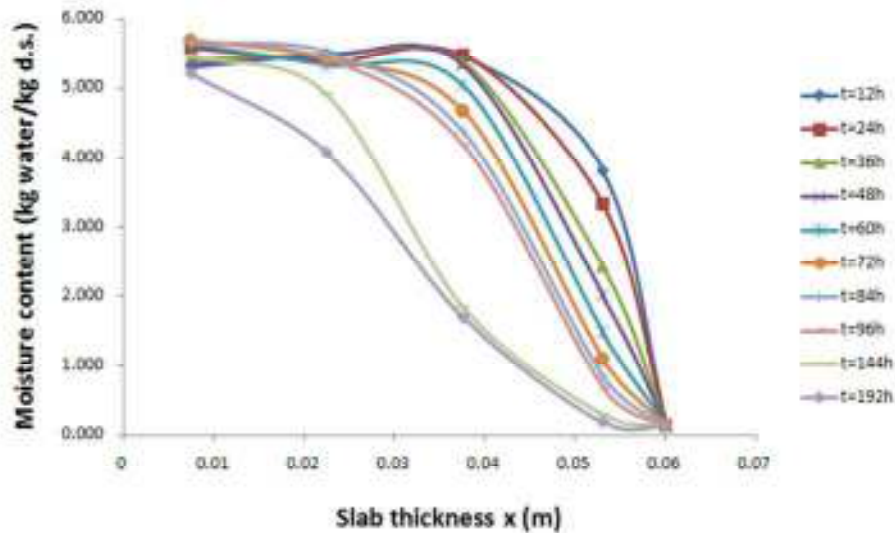

Figure 4.7: Variation of Moisture content (kg water/kg d.s.) vs. slab thickness.

Some problems present the two last experimental values of moisture for each positions  $x=0.0375$  m and  $x=0.0530$  m, due that, four experimental values, the last two values for each  $x$  will considered as “out layers” for the successive analysis. The main reasons is: for the first 96 hours the variation of testing time was constant of 12 hours, after that, the variation of testing time was 48 hours, even the process was still running with the same conditions. Additionally, while for the first 96 hours, 3 sample of each test were considered; for the last testing, just one sample was considered. For the first positions  $x=0.0075$  m and  $x=0.0225$  m the variation between those values regarding to the first samples is not well remarkable, while for the successive positions the tendency of those values is not very accurate.

These experimental results are similar to other which have been published on the literature of the drying process of sewage sludge.

## 4.4. Simulations results

Some analysis were done in order to get the best values for the parameters of the model selected and to obtain acceptable correlations between simulated and experimental data as well as to know the value for diffusion moisture coefficient for this case study. First simulations were done assuming constant diffusion coefficient, while the successive simulations were done considered non-constant diffusion coefficient. The analysis for the simulations is presented in this section.

### 4.4.1. On the case of constant diffusion coefficient

Simulations assuming constant diffusion moisture coefficient were carried out using MathCAD in order to compare the behavior of the curves with the experimental results. Some values of diffusion coefficient has been studied for many researches in the cases of sludge from wastewater or sludge from foods processing. Table 4.1 shows the results of these researches at different temperatures.

Table 4.1: Values of diffusion coefficient in sludge drying for various operational conditions.

Author	Moisture content	Air flows	Temperature	Ranging of values
R. Font et al. (2011)	2.78 kg water/kg solid	-	40°C	$3 \times 10^{-9}$ m <sup>2</sup> /s
	0.006 kg water/kg solid		40°C	$1 \times 10^{-8}$ m <sup>2</sup> /s
A. Celma et al (2007)	Since 2 to 0.7 - 0.08 kg water/kg d.s.	1.0 m/s	20°C	$2.224 \times 10^{-10}$ m <sup>2</sup> /s
			40°C	$4.544 \times 10^{-10}$ m <sup>2</sup> /s
			80°C	$6.993 \times 10^{-10}$ m <sup>2</sup> /s
R. Jiang et al (2009)			80°C	$8.49 \times 10^{-10}$ m <sup>2</sup> /s
			120°C	$2.71 \times 10^{-9}$ m <sup>2</sup> /s
			150°C	$4.39 \times 10^{-9}$ m <sup>2</sup> /s
A. Celma et al (2011)	Since 173 wt% to 7 wt%	0.9 m/s	30°C	$6.112 \times 10^{-10}$ m <sup>2</sup> /s
			40°C	$7.628 \times 10^{-10}$ m <sup>2</sup> /s
			50°C	$1.287 \times 10^{-9}$ m <sup>2</sup> /s
			30°C	$1.028 \times 10^{-9}$ m <sup>2</sup> /s
			40°C	$1.427 \times 10^{-9}$ m <sup>2</sup> /s
		1.3 m/s	30°C	$2.541 \times 10^{-9}$ m <sup>2</sup> /s

In this work and for this first runs moisture content was assumed constant along all thickness of the layer. MathCAD simulation shows the results ranging from 0.00m (bottom) to 0.06m (surface of the layer). At position 0m (the first particle in the bottom of the layer), the measurement of moisture was difficult, as well as for position 0.06 m (the last particle in the surface). The graphics 4.8 and 4.9 were plotted taking account considerations of initial moisture of 5.604 kg water/kg d.s. taking from the results of the sterilization process, and the assumption of equilibrium moisture in the surface with a value of 0.130 kg water/kg d.s.

After several runs and the comparison with experimental results, the best value of diffusion coefficient was found about  $7.41 \times 10^{-10}$  m<sup>2</sup>/s, with the follow errors: 3.27%, 3.13%, 7.17% and 35.5% for the positions  $x=0.0075$  m,  $x=0.0225$  m,  $x=0.0375$  m and  $x=0.0530$  m

respectively, and with average error of 12.27%. Figures 4.10 and 4.11 show the correlation results.

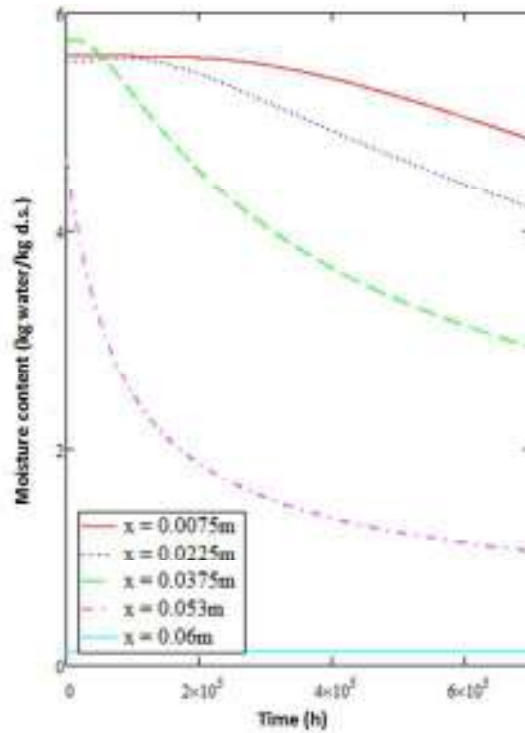

Figure 4.8: Variation of moisture content (kg.water/kg d.s.) vs. time at constant diffusion coefficient.

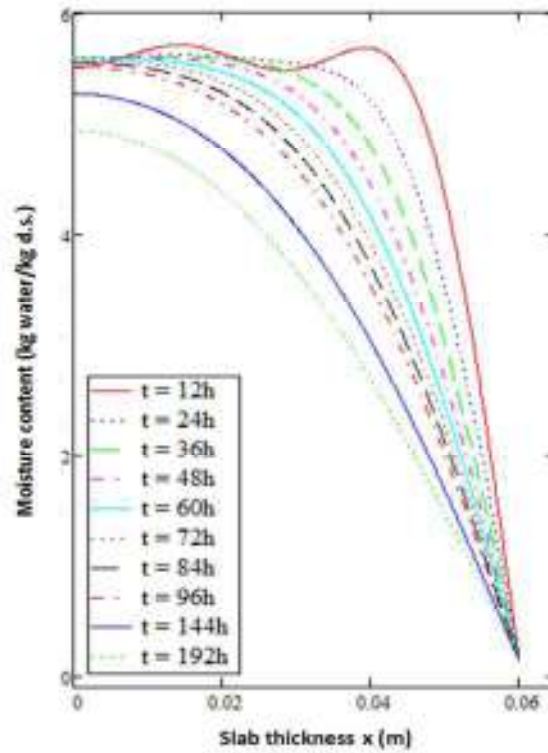

Figure 4.9: Variation of moisture content (kg.water/kg d.s.) vs. slab thickness at constant diffusion coefficient.

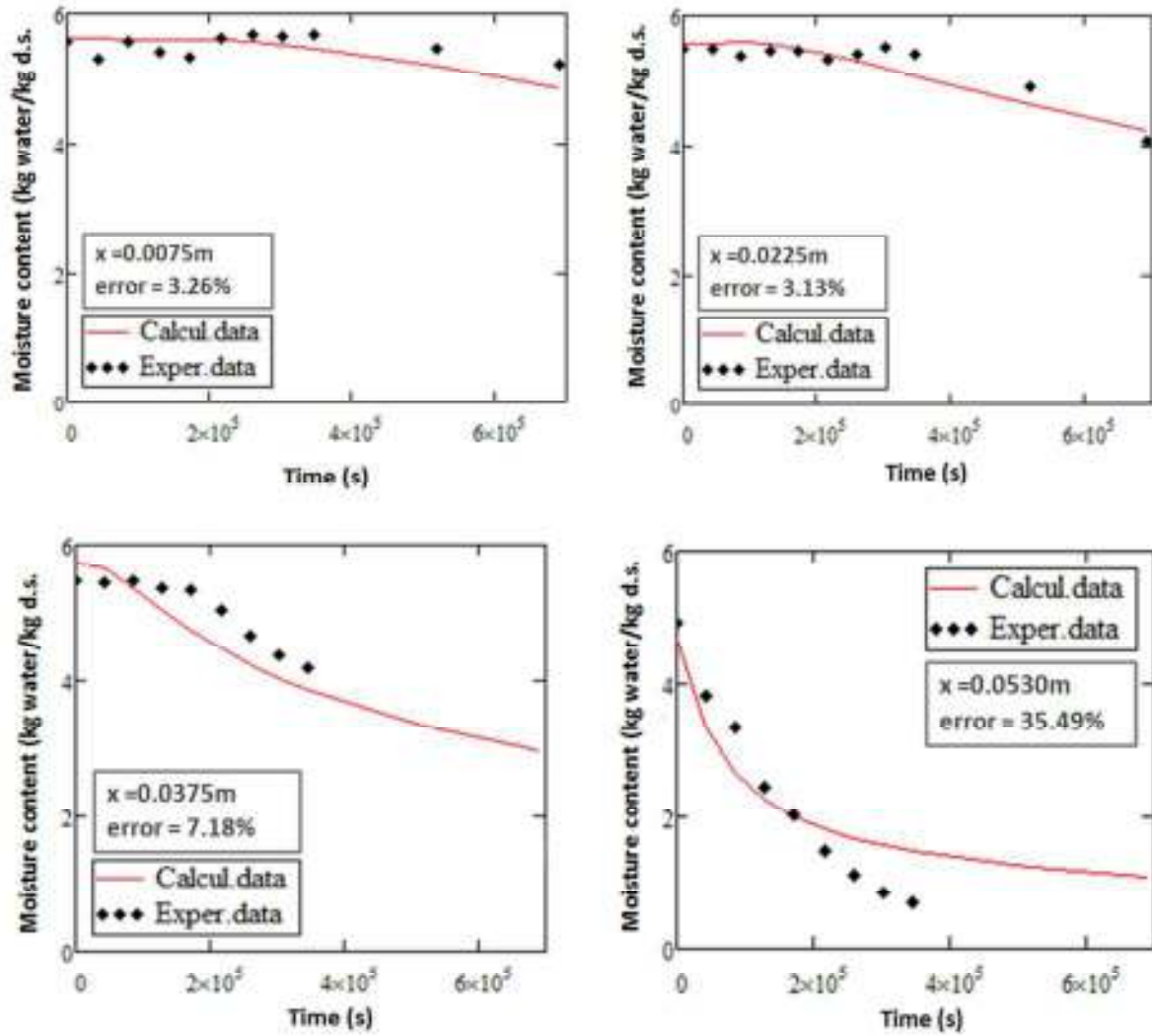

Figure 4.10: Correlations between experimental ( $\blacklozenge$ ) and simulated ( $-$ ) values of moisture in the time for each position assuming constant diffusion coefficient.

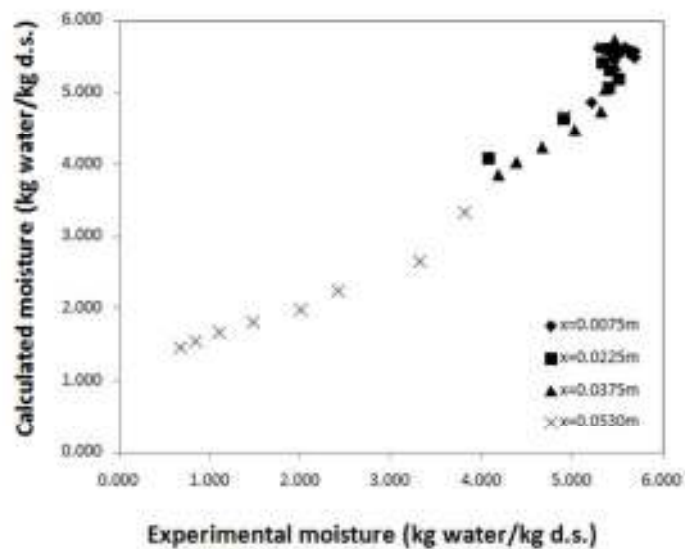

Figure 4.11: Values for experimental and calculated moisture assuming constant diffusion coefficient.

These results show that for the position  $x=0.0375$  m in the figure 4.8 the decreasing moisture behavior presents a notable step and it is more prominent for the position  $x=0.0530$  m, but making a comparison between simulated and experimental results, the biggest errors were found for those positions. With figures 4.10 and 4.11 it is note that the correlations of experimental and simulated data are not fitted well. Moreover, the moisture is immediately decrease and constant for the position  $x=0.0600$  m, thus it is corresponding to the equilibrium moisture and checking as right the assumption of moisture equilibrium for experimental results show in figure 4.6 and useful for the subsequent analysis. The initial oscillations shown in figure 4.9 and the fact of not all curves began with the same concentration were observed due to the inaccuracy solutions and the assumptions of constant diffusivity, in fact, the process is start becomes stable after 48 h presenting a step for all of curves and finishing in the same moisture due to the equilibrium at the surface. These graphics were very helpful in fitting the boundary conditions for the following procedure.

Many other values for diffusion coefficient were evaluated with MathCAD and compared with experimental values, especially for the position  $x=0.053$  m because it is the more critical curve. They are registered in the figure 4.12. As it is shown for any value of constant Diffusion Coefficient, the correlation with experimental data is never fitted.

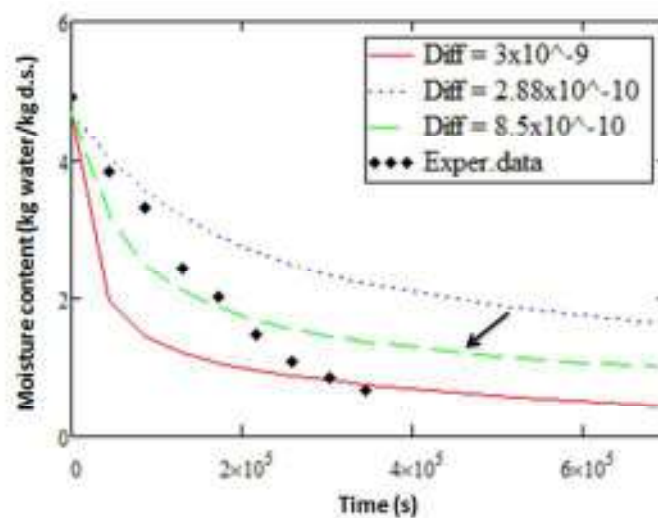

Figure 4.12: Variation of concentration vs. time for different values of the diffusion coefficient at the position  $x=0.053$  m.

In view of these results, this analysis is uncertain and unstable, then the diffusion coefficient must not be constant, and an optimization process is necessary.

A complete development of mathematical procedure in MathCAD for this case is reported in annex 3.

#### 4.4.2. On the case of non-constant diffusion coefficient: the optimization process.

Simulations for the case of non-constant diffusion coefficient were done in Excel spreadsheets applying the discretized equations and the model for diffusion coefficient



given by Font et al. The runs have been done using nonlinear regression techniques. Many spreadsheets were developed making a matrix for many values of  $\Delta t$  and simulating many layers of sludge (9 layers) with  $\Delta x$  of 0.0075 m., according to part "a" from figure 4.3. Temperature was fixed on 50°C, and boundary conditions found through experimental and simulated activities were considered.

First runs were done using the values of 0.140 and 0.0946 for the parameters of 0.140 and 0.0946 obtained by Font R, et al. The results were extreme. The objective function was about 86.50 with error about 15.95%, 23.12%, 35.51%, 32.29% for the positions  $x=0.0075$  m,  $x=0.0225$  m,  $x=0.0375$  m and  $x=0.0530$  m respectively, with the average error was about 26.72%. The following graphics were plotting for these parameters:

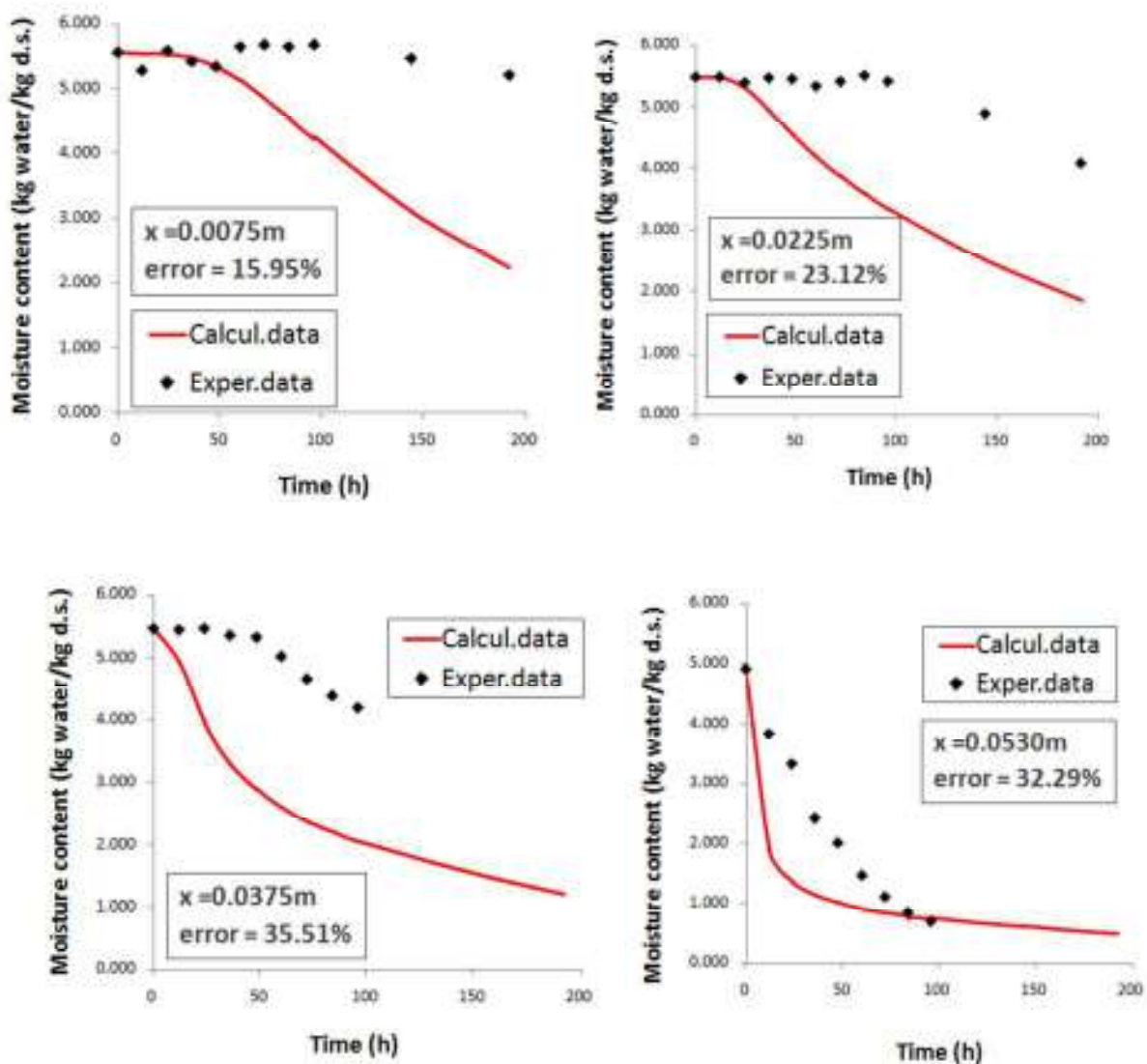

Figure 4.13: Correlations between experimental (♦) and simulated (—) values of moisture using  $\alpha=0.140$   $\beta=0.0946$  in the time for each position.

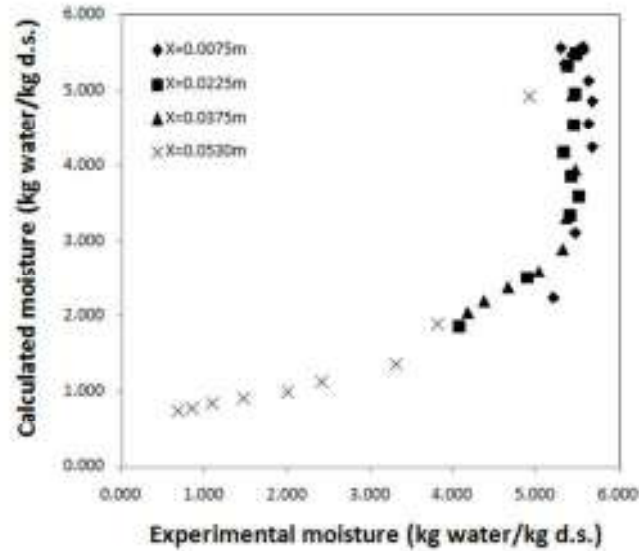

Figure 4.14: Values for experimental and calculated moisture for the selected model.

Here, also it is note that calculated and experimental values for moisture fitted too badly. With 50°C effective diffusion coefficient varies from  $3.02 \times 10^{-9}$  and  $1.60 \times 10^{-9}$  m<sup>2</sup>/s. Figure 4.15 shows the effective diffusivity of the calculated data as a function of moisture content calculated as indicated in Equation 4.8. The value for the effective diffusivity was observed to increase as the moisture content was reduced following a linear tendency.

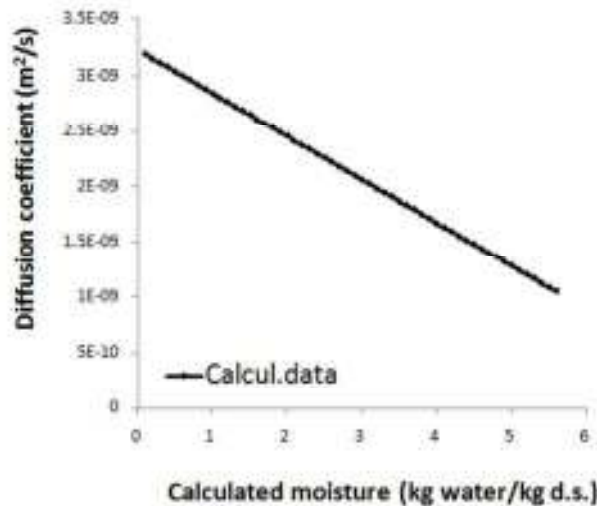

Figure 4.15: Dependence of effective moisture diffusivity on moisture content.

The results shows the necessity of an optimization process implementation, in this way the following runs were done changing values of the parameters  $\alpha$  and  $\beta$  in order to reduce the objective function and average errors. Using Excel spreadsheet, the procedure was follow.

1. Initially, the first attempts were applying values proposed by Font et al.

2. SOLVER and What-if-analysis functions of Excel were used to obtain the best parameters that minimized the sum of the square between the calculated and experimental values of moisture content (Objective function).
3. After several trials and errors, certain parameters were fixed for all the runs. Optimized values were compared with those proposed in literature.
4. The procedure was repeated many times for different values of  $\Delta t$  (3,600 sec; 2,700 sec; 1,800 sec and 60 sec). The variation between the results was minimal, about 0.008.

Afterwards, acceptable correlations between calculated and experimental values were found, giving about a 95.98% reduction in the objective function. Diffusion coefficient values found were varying from  $1.34 \times 10^{-11} \text{ m}^2/\text{s}$  for moisture content about 5.5 kg water/kg d.s. to  $8.58 \times 10^{-10} \text{ m}^2/\text{s}$  for moisture content about 0.82 kg water/kg d.s. Also here, the effective diffusivity increases during the drying process following a linear tendency. The optimized values of the parameters were fixed of 0.0435 for  $\alpha$  and 0.0341 for  $\beta$ . The average errors for each position were 2.51%, 2.50%, 4.28% and 25.35% for  $x=0.0075 \text{ m}$ ,  $x=0.0225 \text{ m}$ ,  $x=0.0375 \text{ m}$  and  $x=0.0530 \text{ m}$  respectively, while the average total error was 8.66%. The following graphics were plotting for these simulations:

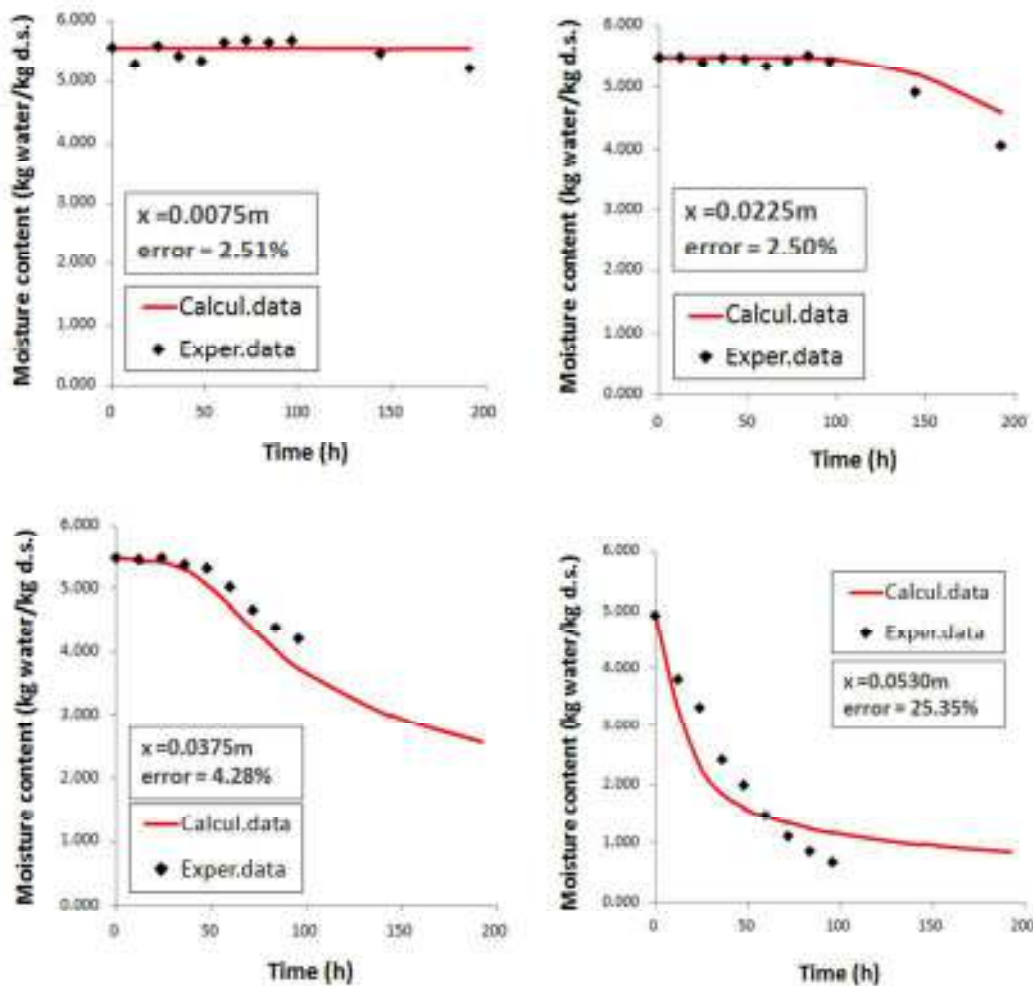

Figure 4.16: Correlations between experimental ( $\blacklozenge$ ) and simulated ( $-$ ) values of moisture using optimized parameters ( $\alpha=0.0435$  and  $\beta=0.0431$ ) in the time for each position.

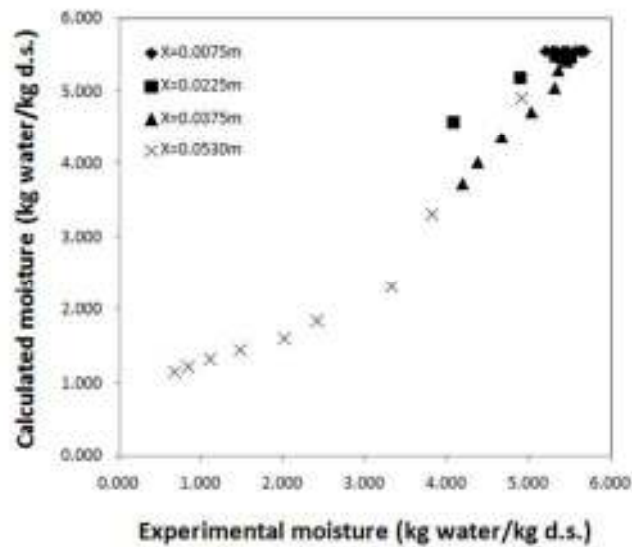

Figure 4.17: Values for experimental and calculated moisture for the selected model with optimized parameters.

For this case, the differences between calculated and measured concentrations show small variations, especially for the initial and intermediate layers. Acceptable correlations between measured and predicted values have been obtained. The observed deviations could be explained by several reasons: 1) the model is only an approximation; 2) the bulk sample of sludge put into the centrifuge tube was not perfectly uniform giving a non-uniform drying process, 3) after sterilization process the mass of the sample has little variation; 4) the model is based on concentration and the density and EMC were not measured for this specific sludge, 5) non-significant changes occur during the first part of the experiments, and 6) the irregular formation of cracks could be important reasons for deviations between the simulated and experimental data.

The graphic 4.18 shows the behavior of the diffusion coefficient for the three cases analyzed. As expected, the curve is a linearly line. The line is obviously constant for MathCAD simulation, while for the excel simulations the diffusion is varying with drying process. Diffusion moisture coefficient increases while concentration decrease, but it is heavy depend on the parameters. In fact, the drying process is fast for the parameters proposed by Font as shown in figure 4.13, but it is not appropriated for the experimental results obtained in this work. On the contrary, with the optimized parameters the drying process is low and is appropriated for this work as shown in figure 4.16. All results must be note that these correlations are valid.

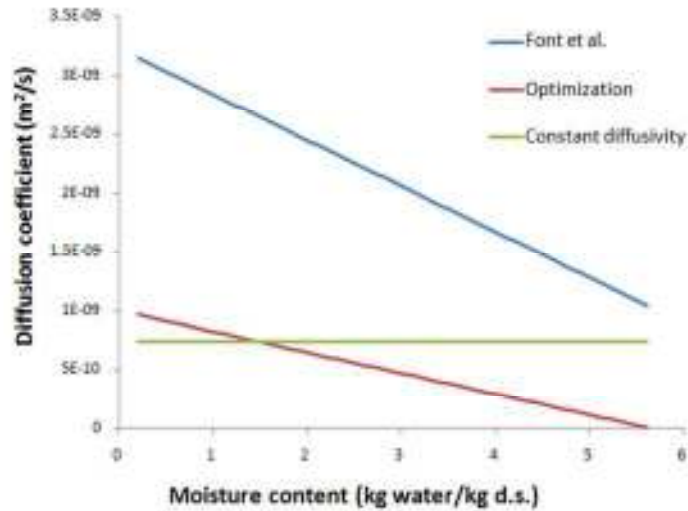

Figure 4.18: Comparison of effective diffusivity vs. moisture content for different models

#### 4.5. Discussion

Sewage sludge is a heterogeneous material and so it can have different behaviors. The mixture of chemical, biological, and other components make for different kinds of sludge, but they are comparable in many ways. A characterization of components is important in order to study better the specific behavior for each kind of sludge. Some parameters can cause differences among the many kinds of sludge. Consequently, the diverse drying processes could display different kinetic models and parameters.

The thermal drying of sludge was studied at 50°C temperature making a comparison of the variation for experimental and simulated moisture content vs. operation time. The experimental activities were done without airflow, and then the time period need to reduce the moisture content of the sample was too long. A model proposed by Font et al, was used for the calculation of diffusion moisture coefficient and discretized expressions on the time and on the position of Fick's law of diffusion were applied in order to calculate the moisture content. The results were the correlations of experimental and simulated data vs. time.

In the model proposed by Font, the term  $0.140 - 0.0946 M/M_0$  (kg/m.s) was introduced to make their expression applicable for all runs. This term varied from 0.00072 kg/m.s at the beginning of the run and 0.032 kg/m.s during the latter part of the run when the sample is nearly dry. As seen in the results the parameters are very important to consider the influence of the diffusion phenomenon. Diffusion coefficient is lesser at the beginning of the run when the particles pores are full with water than afterwards when the pores are not full of water and diffusion of liquid and vapor water can take place. The value of 3,425 K corresponds to the activation energy and the influence of this parameter is small.

Using non-linear regression techniques, the results were analyzed initially with parameters taken from literature, giving values for  $\alpha$  and  $\beta$  of 0.140 and 0.0946 proposed by Font et.al, the first runs have unacceptable results. Then, through an optimization process, new values showed similar behavior for both experimental and simulated data, and acceptable correlations have been obtained for the variation of moisture content vs. time. For some runs were significant deviations between the experimental and calculated data which could be explained by the sludge were pipeted into propylene centrifuge tube, then the temperature could be not constant for any particle along the deep of the layer presenting little variations and only the upper part of the sample was directly contact with the atmosphere. In fact, non-significant variations of moisture content was observed for layer at the bottom of the test tube, while significant variations could be observed for the layer near to the surface and the big errors on the correlations were found for the runs in these layers. The errors were corrected considering the critical experimental values as “out layers”.

While, the other variations could be explained by the layer formations was done handmade and not perfect, the sludge was sterilized previously with 80°C, bubbles of air could be present along the layer despite the tries to avoid them, then the drying process could be not uniform.

The more critical results were obtained for the last layer analyzed experimentally because the variation of moisture is greatly appreciated. Even, it was determinate that the simulated data obtained during the first runs (with time ranging from 0 hours to 96 hours) fitted well with the experimental data, while significant differences were noted for the latter runs (with time after 96 hours). By the way, considering all the data presented in the figures it can be deduced the correlations can be considered as acceptable. While, the model reported by Font et al. could be expected to work only for that specific case, for example with short drying times. Shrinkage and skin effects were not considered in this work.

The model studied here was helpful in measuring the effective diffusion coefficient. If the parameters were changed according to the initial conditions, the new parameters found could be applied to different kinds of sludge.

## **CHAPTER 5: ENERGY VALORIZATION OF SEWAGE SLUDGE: GASIFICATION PROCESS SIMULATION**

As initially provided, the completion of this research is the energy valorization of sludge from wastewater treatment plants. The utilization of sewage sludge to produce energy represents an innovative process with actually few application around the world but optimal perspectives for the future due to the proprieties of sludge that contains hydrocarbons and inorganic materials.

Thermochemical valorization of sludge is a way to get energy, main thermochemical conversion techniques are direct combustion, pyrolysis and gasification. Particularly, gasification is an alternative of treatment which can reduce the amount of solid for successively energy recovering, obtaining a syngas rich in hydrogen that can be used in both traditional and innovative systems.

Even though gasification is an ancient technology that fell into disuse, nowadays is resurfacing and has a great development potential (Elias, 2005). In the future it would be economically competitive and it is already respectful with the environment. Regarding gasification of sewage sludge, the process is still in phase of research through laboratory and pilot experiences due to especially the nature of this material, results have shown a good potential of sewage sludge used as feed stock material for gasification.

However sludge is a very wet residual, and the moisture content depends of the type of treatment it have been submitted prior, then, application of water removal techniques must be necessary in order to reduce the water content. As studied in the previous chapter, one kind of treatment could be drying.

Gasification can have some advantages. It is the unique technology of energy conversion which offers flexibility and advantages on the type of material fed and kind of gas obtained. It is an efficient technology and with the less environmental impact specially for electricity generation. The efficiency is greater when the system is integrated with fuel cells and other advances technologies.

In this chapter, the potential of sewage sludge, once dried, was evaluated in order to be used as fuel for energy generation by gasification. Gasification process was numerically simulated in order to evaluated the efficiency of the process and the quality of syngas obtained.

### **5.1. Energy recovery from sewage sludge**

Energy recovery from sewage sludge is having successful in the last years especially regarding the research of innovative treatment methods for recovery and reuse of products from sludge treatment processes and economic and environmental assessments [Rulkens et al, 2004].

Nowadays, there are many alternatives for the recovery of energy from sewage sludge. They can be subdivided into nine groups [Rulkens, 2008]:

1. Anaerobic digestion of sewage sludge
2. Production of biofuel from sewage sludge
3. Direct production of electricity from sewage sludge in microbial fuel cells
4. Incineration of sewage sludge with energy recovery
5. Co-incineration of sewage sludge in coal-fired power plants
6. Gasification and pyrolysis of sewage sludge
7. Use of sludge as an energy and raw material source in the production of Portland cement and building materials.
8. Supercritical wet oxidation of sewage sludge; and,
9. Hydrothermal treatment of sewage sludge.

Most of these options are actually being applied in industrial scale, other are in research phase.

Anaerobic digestion is the most common and it is applied to large-size and medium-size plants, currently is applying also for small size plants. It is used to stabilize the sludge and convert the volatile compounds into biogas (methane). The biogas can be applied as an energy resource at the plant itself or elsewhere for the production of electricity or heat.

There are hardly any or few studies on the production of biofuel (ethanol, butanol, acetone or hydrogen) from sewage sludge due to the presence of toxic and inorganic compounds and require complex separation systems, additionally, the results of the experiments are not very promising taking into account the simple way to produce methane. Research demonstrated that it is doubtful that the production of the biofuels from sewage sludge will become in the future a serious alternative for biogas production.

Microbial fuel cells can be used to produce directly electricity from a wastewater stream containing biodegradable organic compounds, and the possibility for the application on sewage sludge is being investigated. First results are promising but it will be a long way to be suitable for large-scale treatment of sewage sludge, specially due to that not all of the organic material in sewage sludge is biodegradable and bioavailable for the energy production, but it is possible to increase the fraction of organic material bioavailable through chemical or microbiological pretreatments; sludge contains a lot of colloidal particles and polymer substances that tend to adsorb to all types of surfaces and can plug the internal structure of the microbial fuel cell. Due to the presence of toxic compounds, a further post-treatment must be necessary

Incineration and co-incineration of sewage sludge can be applied to the mechanically dewatered sludge or dried sludge, but it presents potential environmental problems such as the emissions of pollutants with the exhaust gases to the atmosphere and with the quality of the ashes; moreover, the costs of an efficient incineration process and gas treatment systems are very high. However, there are standard technologies available to abate the gaseous emissions very efficiently, heavy metals in the ash becomes a not real environmental problem, because they are very well-immobilized and resistant to leaching,



ashes can be disposed or used as a source for the production of building materials. The energy produced can be used for production of electricity or in drying processes prior to the incineration [Rulkens, 2008]. Co-incineration in coal-fired power plants is a way to reduce operation costs, and the energy recovery can strongly be increased, problems related to emissions and ash quality can be neglected. The use of polluted drying gas can contribute to a better total process performance. Both process are being used in practice in large-scale plants and with a combination of municipal wastes in the case of co-incineration [Lin et al, 2012].

Inorganic and organic compounds of sludge can be used in a beneficial way for the construction field through thermal solidification of these components obtained after combustion of sludge. The process occur in high temperatures, up to 1,000°C, in this way toxic organics are destroyed. Various types of products can be made, such as artificial light-weight aggregates, slags, and bricks [Weng et al, 2003]. The energy efficiencies is not very high and costs are also high.

Supercritical oxidation of sludge has advantages in comparison to sludge oxidations. The process occurs at temperatures and pressures above the supercritical point of water ( $T > 350^\circ\text{C}$  and  $P > 220$  bar) in a supercritical reactor with retention times in order of few seconds or 1 minute. Because, it is not necessary to dewater the sludge prior to the oxidation process, the gas obtained treatment is very simple and inorganics can be easily removed, this technology is economically and sustainability competitive [Svanström et al, 2004]. However, large-scale experiences are not available yet. Some potential corrosion problems might be a bottleneck.

Thermal hydrolysis is a new technology applicable to sewage sludge. Sludge is heated as an aqueous phase to high temperature/pressure saturated steam ( $200^\circ\text{C}$ , 2 MPa) with the aim of disintegrating the sludge and making possible to recover and recycle useful resources from the sludge, such as volatile fatty acids, phosphorous compounds, organic compounds for enhanced anaerobic biogas production, and coagulants; and at the same time energy recovery can be used in order to improve the dewatering and anaerobic digestion ability of the sludge [Meng et al, 2012]. Regarding toxic compounds, an intensive post-treatment must be necessary [Rulkens, 2008].

Pyrolysis and gasification have some potential advantages compared to other processes: a hydrogen-rich syngas is produced which can be used in traditional power-generation system or more advanced technologies as fuel cells, this conversion of the combustibles gases into electrical power can be achieved more efficiently, valuable gases can be produced as basic chemicals or as fuel, it is not necessary to treat large amounts of waste gases. However, the presence of toxic organic pollutants in the sewage sludge makes the treatment process of the gases can be more complicated. Generally, the performance of the process is complicated and the current research about, specially gasification is very limited.

Pyrolysis is a thermal treatment process in which the sludge is heated under pressure to a temperature of 350 – 500°C in the absence of oxygen [Stolarek et al,2001], the requirement of heat is totally provided by the external sources. The sludge is converted

into char, ash, pyrolysis oils, water vapor, and combustible gases. Syngas produced is equivalent to 15 - 30% of weight of the original organic material, main results materials are: CO, CO<sub>2</sub>, hydrocarbons (CH<sub>4</sub>, C<sub>2</sub>H<sub>4</sub>, C<sub>3</sub>H<sub>6</sub>), H<sub>2</sub>O, H<sub>2</sub> with a LHV (Low heating value) ranging from 8 to 12 MJ/m<sup>3</sup> [Del Buono et al, 2007]. Pyrolysis oils are equivalent to 50 - 60% of weight of original organic matter; they are obtained from the vapor phase and associated with combustible oil. It contains water and organic compounds with low molecular weight such as aldehydes, acids, ketones, and alcohols. And char is reduced in volume and weight respect to the original matter, it contains the highest molecular weight, furans derivate from phenolic compounds. Char has a LHV ranging from 21 to 25 MJ/m<sup>3</sup> [Del Buono et al, 2007].

The performance of the process can be improved making progress on the operational conditions such as: final temperature of the reaction, heating velocity of biomass, operational pressure, residence time of material and reaction temperature, dimensions and shape of the biomass and presence of determinate catalysts.

Gasification is different from pyrolysis principally because the conversion process takes place with a "gasification agent" (steam, oxygen and/or air) which can to modify the characteristics of the gas produced on the equilibrium of gaseous phase or favoring the decomposition of solid matrix. It involves the breakdown of dried sludge in ash and combustible gases at temperature usually about 1000°C and one atmosphere but with a reduced amount of the gasification agent [Jaeger et al, 2004]. It is not a complete oxidation. The gas results is called "Syngas" with a LHV of about 10 MJ/Nm<sup>3</sup> [Del Buono et al, 2007] and contains CO<sub>2</sub>, CO, H<sub>2</sub>, CH<sub>4</sub>, H<sub>2</sub>O, traces of hydrocarbons with high molecular weight and various pollutants.

## 5.2. Composition of sewage sludge

The sludge, in general, is a combination of primary sludge and secondary (microbiological) sludge and contains a substantial amount of inorganic material and a small quantity of toxic compounds. In order to study the energy applications of sludge, an analysis of the composition is very important. According to Rulkens [Rulkens, 2008], its composition is characterized by six groups of components:

1. Nontoxic organic carbon compounds (approximately 60% on a dry basis), for a large part from biological origin.
2. Nitrogen and phosphorous containing components.
3. Toxic inorganic and organic pollutants, like as, heavy metals (Zn, Pb, Cu, Cr, Ni, Cd, Hg and As with concentrations varying from more than 1000 ppm to less than 1 ppm), polychlorinated biphenyls (PCBs), polycyclic aromatic hydrocarbons (PAHs), dioxins, pesticides, linear-alkyl-sulfonates, nonyl-phenols, polybrominated fire retardants, etc.
4. Pathogens and other microbiological pollutants.
5. Inorganic compounds such as silicates, aluminates, calcium and magnesium.
6. And water, varying from a few percentage to more than 95%. Dewatered sludge generally has 85%.

The typical composition of digested sludge from WWTP in dry basis is 53.0% C, 7.2% H, 35.5% O, 4.53% N, 0.8% S. Ash contents is about 37% [Elias X, 2005]. According to Elias the LHV of sewage sludge is about 5,100 kcal/kg or greater (equivalent to 2.14 MJ/kg).

The problem is all these compounds are present in one mixture. Organic carbon, phosphorous and nitrogen can be considered as valuable compounds as well as inorganic compounds. Sustainable treatments involve the recovery and useful reuse of the valuable components and the minimization of the possible adverse impact on the environment and humans. The amount of nitrogen is small compared to the amount of these components present in wastewater. The amount of phosphorous depends upon the type of wastewater treatment process. The great quantity of water demands strong drying process.

### 5.3. Drying sludge

Any kind of treatment for the recovery of energy from sewage sludge will applied, water removal is required. Available techniques to reduce the water content include composting, dewatering, drying and incineration. Dewatering is one of the most widely used techniques in the mass reduction of sludge from the wastewater treatment processes. However, final moisture content of dewatered sludge cakes are usually higher than 75%.

Drying sludge is the more useful process for following energy applications. From the experience discussed in chapter 4, a more efficient drying pre-treatment must be necessary to implemented , and it is studied a particular attractive dryer which is a fluidized bed dryer development also by Prof. Vasquez and Prof. Coronella [Coronella, et al. 2010] at the Chemical and Materials Engineering's laboratories of the UNR. The dryer dries the sludge to a degree sufficient for a thermochemical process to be carried out on the sludge. The thermochemical converter in this work is a gasifier.

The sludge is transmitted to the dryer in the form normally produced by the water treatment facility, when transmitted to the dryer, the sludge has a moisture content of at least about 80 - 85 wt%, after leaving the dryer, the sludge, now dried sludge, has a moisture content of less than about 30 wt%.

The fluidized bed includes a bed media having a density different than the density of a feed material to be dried in the dryer. The bed media has a density greater than the feed material density. The bed media is an inert media such as sand. Using bed media having a different density that the feed material can be useful in removing dried feed material from the dryer while maintaining the bed media in the dryer. A scheme of the dryer is shown in the figure 5.1.

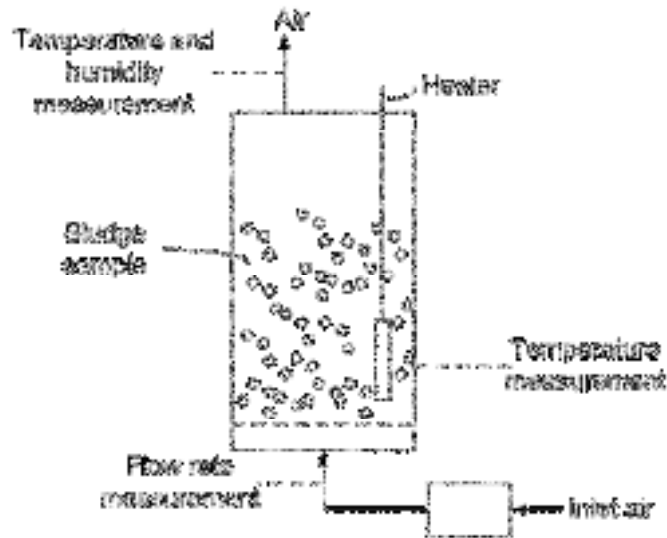

Figure 5.1. A schematic diagram of a fluidized bed dryer development by Coronella and Vasquez [Coronella, et al. 2010]

Air is blown upwards through the bed media and sludge is fed continuously to the bed and continuously withdrawn with the air. Heat can be supplied by tubing through the bed. This kind of dryer can have several advantages including compact design, rapid heat transfer between the tubes and the bed, and rapid heat and mass transfer between the sludge and the bed. It can also be operated in batch or semi-batch modes.

The temperature inside the fluidized bed was chosen between ranges 50 – 80°C. At this temperature average residence time of sludge was taken from the batch fluidized-bed drying test. The pictures from 5.2 to 5.4 report the tests made by Coronella and Vasquez at UNR for drying sludge in the fluidized bed dryer in order to show the efficiency of this technology.

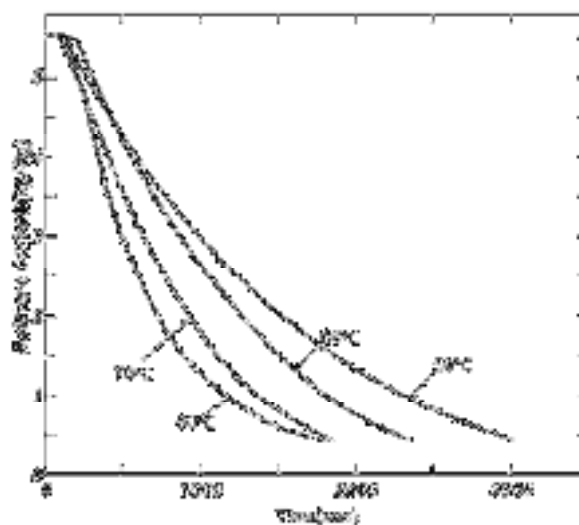

Figure 5.2. Moisture content vs. time for sludge dried at 50°C, 60°C, 70°C and 80°C

The measurements of moisture content were done in samples of dewatered sludge with an initial moisture content of about 5.5 kg water/kg d.s which is equivalent to 85% of humidity in wet basis. It is observed that sludge drying is faster for higher temperatures. The final humidity obtained present values lesser than 15 o 10% (on dry basis) for short drying times. Drying times less than 2,000 seconds were observed for temperatures in the range of 70 - 80°C, while for temperatures of about 50 - 60°C drying times were longer as observed in figure 5.2.

Initial moisture content on wet basis is about 0.85 kg water/kg wet solid). As seen in figure 5.3. The drying velocity (rate) gets the maximum value for moisture content almost constant. In accordance to the drying rate curves for solids [Chun et al, 2004], the drying process of sewage sludge is divided in three periods: the constant rate period, the primary falling rate period and the secondary falling rate period, which are very notable on the figure. The first constant period is achieves for a range of moisture content between 0.85 and 0.80 kg water/kg w.s. which represent a short constant rate period. Primary falling rate period is evident for a range of moisture content from 0.80 to 0.60 kg water/kg w.s., where the velocity of drying is began to decrease. The secondary falling rate period is observed for a range of moisture content from 0.6 to 0.3 kg water/kg w.s. on wet basis; the decreasing of drying velocity is lightly lower than primary falling rate period. In accordance to the literature, as compared to solids drying, sewage sludge have shorter constant rate period and longer falling rate period [Chun et al, 2004].

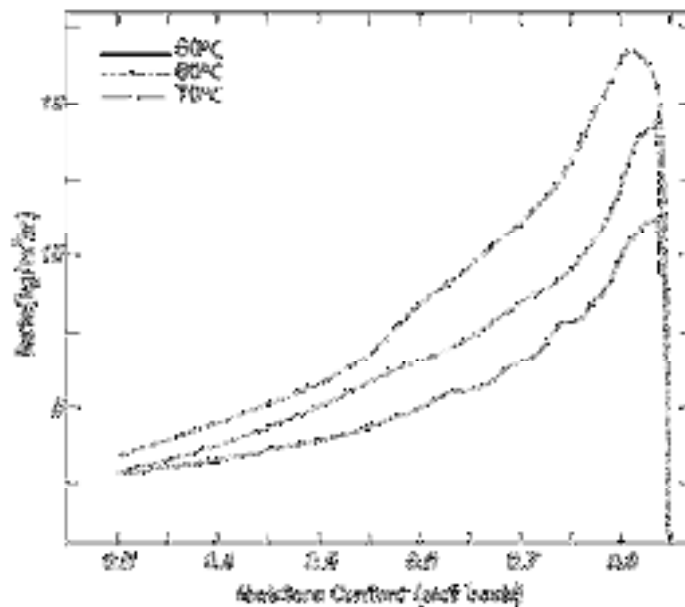

Figure 5.3. Drying rate vs. moisture content for sludge dried at 50°C, 60°C and 70°C.

In figure 5.4., it is shown that the moisture content vs drying time for a temperature of 50°C with different air velocities. It was observed that the influence of the air velocity applied here is neglecting. In fact, the curves observed are overlapping indicating the unchanging of the effects of the air velocity.

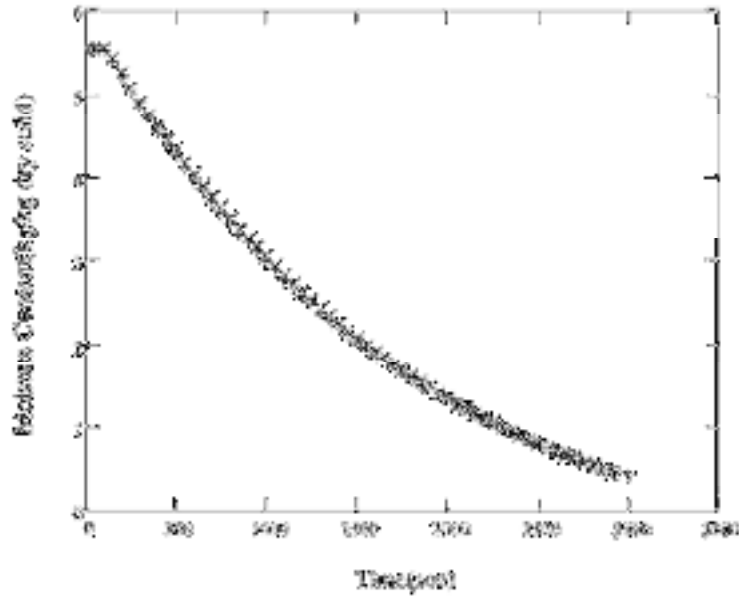
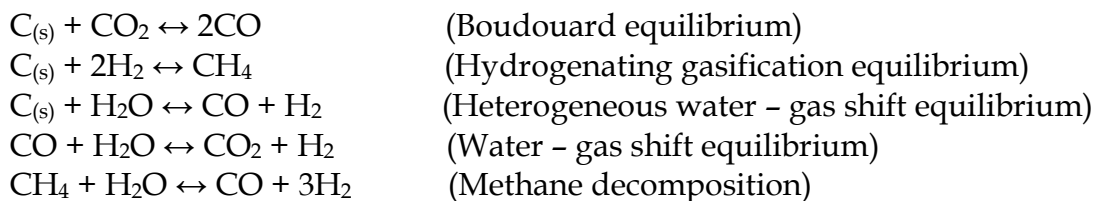

Figure 5.4. Moisture content vs. time for sludge dried at 50°C, at velocities of 7.0 cm/s and 5.2 cm/s.

#### 5.4. Gasification of sewage sludge

Gasification is a complex process which provides three phases: drying, pyrolysis and gasification. In the last phase the real gasification takes place, where, the pyrolysis products (char, condensable hydrocarbon, tar and gases) give as product the gas fuel desired (syngas - CO, CO<sub>2</sub>, and H<sub>2</sub>), and less quantities of hydrocarbons and olefins.

The gasification of carbon from pyrolysis is the interactive combination of diverse gas - solid and gas - gas reactions, in which the solid carbon is oxidized into carbon monoxide and carbon dioxide, and the hydrogen is produced by the water shift reaction. The main reactions of the gasification phase are [Elias X, 2005]:



The operational conditions can influence on the degree of advancement of these reactions, principally on the parameters already mentioned on the pyrolysis process.

- Final temperature on the reaction
- Heating velocity of the biomass
- Pressure
- Residence time of the material at the reaction temperature.
- Dimension and shape of the biomass
- Presence of determinate catalysts
- Type of oxidant agent

- Flow rate of the oxidant.

The oxidant can be oxygen, air, vapor or a mixed of air and vapor. Vapor is preferable because favoring the endothermic reactions of reforming which cause the decreasing of the temperature along the deep of the reactor. Syngas obtained using air is heavy diluted for the presence of high quantity of nitrogen which influence on the Low Heating Value and increasing the amount of syngas.

Temperature is varying between 800 and 1,100 °C, pressure is usually atmospheric, but there are applications using pressure until 20 atm [Del Buono et al, 2007]. Operative conditions are heavy influence of the type of reactor.

The syngas obtained contains CO, CO<sub>2</sub>, H<sub>2</sub>, CH<sub>4</sub>, quite quantities of other more heavy hydrocarbons as C<sub>2</sub>H<sub>6</sub>, C<sub>2</sub>H<sub>4</sub>, H<sub>2</sub>O, N<sub>2</sub> and diverse pollutants as quite carbonous particles, ash, tar and oils. CO and H<sub>2</sub> give heating value to the syngas because they react with oxygen. CH<sub>4</sub> is present in quite quantities and is the responsible of great part of the heating value of the syngas. CO<sub>2</sub> and H<sub>2</sub>O are undesirable products but unavoidable. After being gasified, the syngas can be converted to power such as electricity.

## 5.5. Types of gasification technologies

There are many ways to classified the gasification systems. One way can be regarding the contact system between the material fuel and the oxidant agent. Essentially two types of gasification technologies are most common: Fixed and fluidized bed.

In fixed bed gasifiers, the biomass fuel is injected into the top of the unit and air is fed through two main process [Ngô et al, 2009]:

- Updraft gasifier; it is when the oxidant is fed from the bottom though the grade and leave the reactor at the top. Biomass fuel and oxidant move in countercurrents. Syngas leaves the reactor at the top too and large amounts of tar is produced.
- Downdraft gasifier; it is when the oxidant and biomass move in the same direction. Syngas leaves the reactor by the bottom and the amount of tar is smaller because the hot zone causes some cracking of the tar.

In fluidized bed gasifiers, a mixture of oxidant, biomass and some inert bed material undergo drying, pyrolysis and gasification at high temperature. Gasification process is more efficient in this system due to the better heat transfer between the gas and the solid phases. The bed of the gasifier can be bubbling bed and circulating bed. Some advantages of this system is its higher capacity, the possibilities of using a larger variety of biomass types, even moist biomass.

A brief description of these types of gasifiers used currently is reassumes in the follow table:

Table 5.1. Diverse types of gasifiers according to the contact way oxidant-solid fuel.

<i>Type of gasifier</i>	<i>Way of contact</i>
<b>Fixed bed gasifier</b>	
Downdraft	Solid fuel and oxidant flow downstream.
Updraft	Solid fuel flows downstream, while oxidant flows upstream
Co-currents	Solid fuel and oxidant flow in the same direction. Downdraft is an example.
Countercurrents	Solid fuel and oxidant flow in countercurrents. Updraft is an example.
Cross-currents	Solid fuel flow downstream and oxidant flows perpendicular to the solid fuel direction.
<b>Fluidized bed gasifier</b>	
Bubbling fluidized bed	Low velocity of syngas. Inert solids (sand bed) remains into the reactor.
Circulating fluidized bed	Inert solids from bed can be carry by the oxidant, but separated and recirculated to the reactor,
Entrained flow	No presence of inert solids. High velocities of syngas generate high velocities of conversion. It can be operate as reactor cyclone.
Double reactor	Gasification and pyrolysis occur in the first reactor, carbon produced is transported to the second reactor where combustion is produced in order to heating the circulating fluidizing means.
<b>Other reactors</b>	
Rotatory furnace	Provides a good contact oxidant-solid fuel.
Reactor cyclones	High velocities and abrasion of particles on the walls of the reactor permit high reaction velocities.

Source: [Elias, 2005]

### 5.5.1. Fixed bed reactors

#### Updraft gasifier:

Biomass is introduced from the top and goes down slowly in countercurrent with the gas generated by oxidant agent introduced from the bottom, biomass is heated until to get the combustion zone where reach the maximum temperature, with subsequent cooling about 200 - 300°C prior to discharge of ash.

Combustion zone temperature is determinates by the temperature of ash fusion. The feedstock material must to be cut and winnow in order to avoid that the fine particles can be carried by the gas.

When the solid arrive the hot zone, a pyrolysis process occur where the volatile components are release making large quantities of char. Afterwards, gasification occurs through a combustion of pyrolysis products. Syngas formed begins to climb to leave the reactor by the top, while ash goes down to the base.



Temperature can reach about 1,000°C and can be controlled through injection of vapour or humidifying the air. The total efficiency of this system is high, but it is also high in tar content.

#### Downdraft gasifier:

Biomass is fed from the top, experiencing the processes of drying and pyrolysis due to the progressive increase of the temperature. Oxidant is fed in the same direction of biomass and the syngas leaves the reactor from the bottom.

The conduction of heat takes place from the top where the heat is generated through partial combustion of the fuel and the products. Gases, tar and char go down and arrive at the oxidation zone where part of the oxygen introduced is burned, providing the energy necessary to keep the thermal process and improving the quality of syngas.

Gasification occurs with high temperatures in a range between 900 to 1,000°C. Syngas is obtained from the bottom of the reactor and tar concentration is smaller than in the updraft reactor.

### **5.5.2. Fluidized bed reactors**

As with fixed bed reactors, fluidized bed reactors are constituted for a cylindrical container with an internal zone and a rack at the bottom. Oxidant is fed from the bottom in an inert material bed which remains suspended. Biomass is fed in a way of fine particles and it remains suspended too.

Temperature is uniform in the reactor and depends on the material to be gasified. For example, when it is carbon, the internal temperature is about 1,100°C, for biomass, it is about 900 - 1,000°C. For MSW (municipal solid wastes), temperatures are higher in order to guarantee the complete decomposition.

The bed promotes the fluidization and mass and heat exchange, it is usually constituted by sand but other catalyzers can be added in order to regulate the tar formation or modify the syngas composition.

Tar formation can be a problem in these systems, ashes are discharged from the bottom but the syngas can contain particles of solids which can be recirculated in more advanced systems. The conversion of carbon can reach 100% with recirculation of ashes.

Volume of syngas obtained by volume unit of the reactor is higher than in fixed bed reactors, and the syngas composition is usually uniform. Syngas leaves the gasifier with high temperatures, then, a heat recuperation system must be implemented in order to keep a good global thermal performance.

Main advantages of fluidized bed reactor are the low operation and construction costs and its flexibility. There are two main types of fluidized bed reactors.

### Bubbling fluidized bed (BFB)

Biomass is introduced into the boiling bed above the grid from which the oxidant is insufflated. Syngas is obtained from the top, and ashes are discharged from the bottom. It can distinguish two phases into the reactor: fluid phase in the bottom and gaseous phase in the top.

Bed temperature is about 700 - 900°C and it is controlled through the relation oxidant/biomass feedstock.

### Circulating fluidized bed (CFB)

Fluid and gaseous phases are not distinguished as in the BFB, because the oxidant velocity is sufficient to carry the solids, but they are separated and the solids are turning back to the reactor improving in this way the efficiency respect to BFB.

Biomass is introduced from the bottom of the gasifier, at a certain distance above the grid of air distribution, where it begins to dehydrate. Subsequently, pyrolysis occurs and gases move towards the upper part of the reactor, while the carbon tends to return towards the denser area of the fluid bed. Carbon remaining is carried by the oxidant and other circulating elements to the cyclone filter, where the separation of solid and syngas occurs, the solids return in the fluid bed and the combustion of carbon with the oxidant occurs.

Internal temperature of the reactor is about 800 - 1,000°C, which depends of the type of material fuel and final applications of the syngas.

A profile of temperatures and percentage of carbon conversion along the depth of the reactor is shown in the figure 5.5.

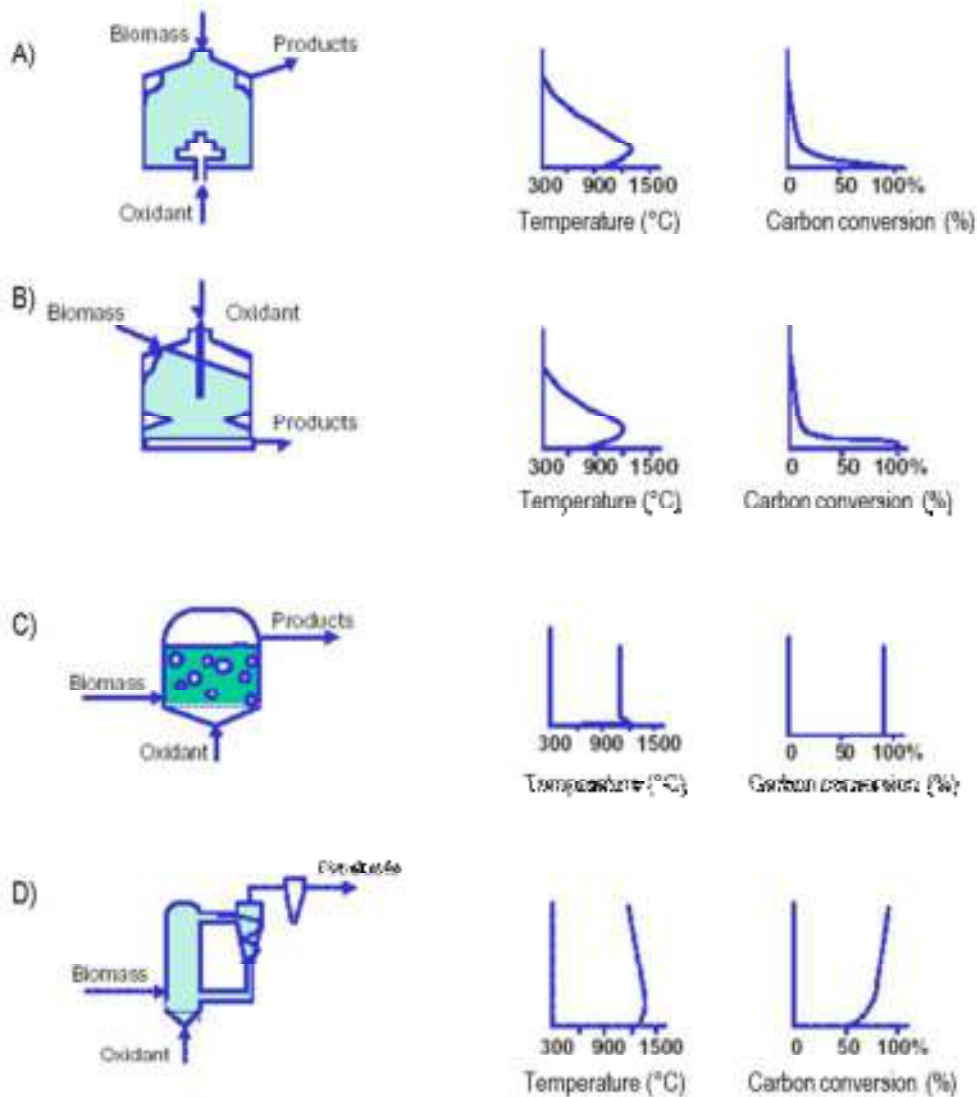

Figure 5.5. Scheme of diverse types of gasifier with profile of temperatures and percentage of carbon conversion along the deep of the reactor. A) Updraft fixed bed reactor. B) Downdraft fixed bed reactor. C) Bubbling fluidized bed reactor. D) Circulating fluidized bed reactor. [Bosio, 2006]

### 5.5.3. Comparison of types of gasifiers.

A general comparison between fixed bed and fluidized bed reactors is shown in the follow table:

Table 5.2. Comparison of fixed and fluidized bed gasifiers.

<i>Criteria/Reactor type</i>	<i>Fixed bed</i>	<i>Fluidized bed</i>
Technical availability	Simple and robust construction Bad temperature distribution Hot spots with exothermic reaction Poor heat exchange Channeling possible Residence time for solids: hours to days. For gas: seconds. Pressure drop is low	Less complex technology. No moving parts Good temperature distribution No hot spots Very good heat exchange Good gas solid contact and mixing. Residence time for solids: seconds to minutes. For gas: seconds Pressure drop is high
Experience	Lots of processes for different applications in operation. Simple, reliable and proven for certain fuels	Commercial designs are available. Large fuel inventory provides safety, reliability and stability.
Scale up	Low specific capacity High residence time of solids Very limited scale-up potential caused by low maximum size.	High specific capacity High reaction rates, low residence time of solids. Very good scale-up potential.
Start-up/shutdown Load change	Long period to heat-up. Limitation of fast change of fuel with different calorific values, high fuel content in bed.	Easily started and stopped. Fast change of different fuels, low fuel content in the bed. Amount of solid is lowered by the high content of inert material in the bed.
Quality of main products	Updraft: Syngas contains tar, oil, phenols and ammonia (require separation and cleanup steam) Downdraft: Amount of tar and phenols in syngas is low. Syngas suitable for direct firing. Updraft: Low exit syngas temperature. Downdraft: High exit syngas temperature. Low ash carry over	Amount of tar and phenols in syngas is low. Gas composition is steady due to uniform conditions in the bed. Syngas exit temperature similar to the bed temperature. Higher particulates in the product gas than at fixed bed.
Quality of co-products	Updraft: Low dust content in syngas. Downdraft: High dust content in syngas.	Inevitable loss of carbon in ash due to the non-uniform solids composition of the bed.
Requirement for subsequent treatment	Extensive gas clean up needed for engines	High dust content in the gaseous phase.
Efficiency of conversion rate	High carbon conversion efficiency	High carbon conversion efficiency.
Environmental	Molten slag possible	Ash not molten
Economy	High investment for high loads	Low investment

Source: Adapted of [Elias, 2005 and Bosio, 2006].

## 5.6. Simulations activity of gasification

For energy recovery from sewage sludge previously dried, numerical simulations of gasification process feeding by this resource have been carried out.

The type of model choose for this feasible analysis is: *Concentrated parameters, at the thermodynamic equilibrium, non-stoichiometric*.

Considering a not detailed model (concentrated parameters) but which permit the preliminary estimations of the quality of the syngas obtained and the evaluation about the convenience of the project, with a simulation of a perfectly mixed reactor with uniform temperature. The equilibrium thermodynamic calculations were done because there is not available experimental data. This model is not restricted to particular conditions and can be applied for different kinds of biomass fed, moreover allows a first comparison among different kinds of gasification plants. Then, since the composition of biomass is unknown and the mechanism of reaction is complex, a non-stoichiometric model can be useful.

However, the real behavior of the process includes a significant deviation of the equilibrium; in this case another model is proposed: *Concentrated parameters, semi-empirical kinetics, non-stoichiometric*. It is based on the literature data available.

Regarding energy balance of the reactor, two conditions have been taken account: isothermal reactor and adiabatic reactor.

The software used was Aspen Plus, which allows the simulation of processes and chemical plants. The model is based on the assumptions of:

- Steady state
- Known flow rates of the elements incoming
- Known temperature of biomass and oxidant
- Uniform operational temperature
- Head losses negligible.

Aspen allows the connection of unit operations, the integration of innovative solutions, the calculation of complex processes with recycling. Moreover, it was possible to develop parametric analysis, research objective functions, and user-defined calculations. These last functions were applied in this work.

Aspen do not recognized the complex sludge molecule, then biomass was written as two input streams: first one involves the sum of main elements (C, H, O and N) in the stream "CHNO", in a way to express the solid-dry fraction of the biomass; and the another one involves the humidity of the sludge which it was represent by the stream "water". In this way the simulation scheme on Aspen was draw as shown in figure 5.5.

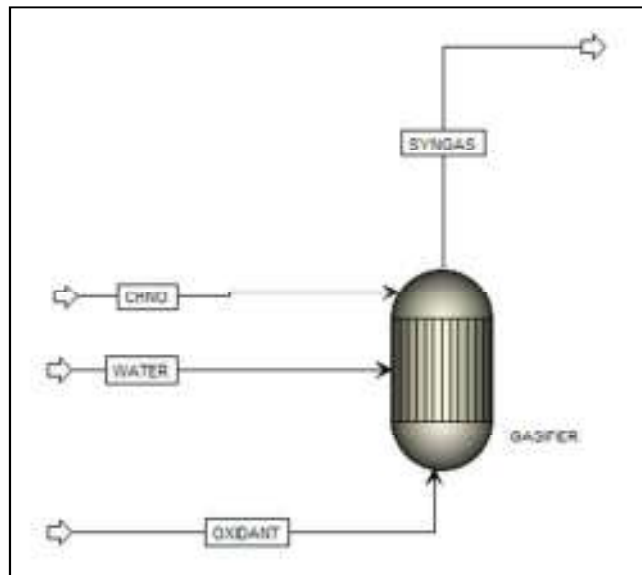
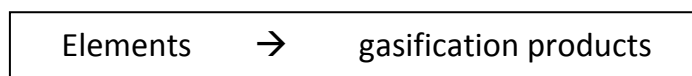

Figure 5.6: Scheme for simulation of sludge gasification.

This model considered the equilibrium of the reaction of the main elements C, H, O and N; allowing the formation of  $\text{CH}_4$ ,  $\text{CO}$ ,  $\text{CO}_2$ ,  $\text{H}_2$ ,  $\text{H}_2\text{O}$ ,  $\text{N}_2$ ,  $\text{O}_2$ ,  $\text{NH}_3$ ,  $\text{NO}_2$ ,  $\text{C}_2\text{H}_2$ ,  $\text{C}_2\text{H}_4$ ,  $\text{C}_2\text{H}_6$ . Ashes were treated as inert and it was calculated only the energy contribution needed for their heating.

In the isothermal reactor, the operational temperature was fixed at  $1000^\circ\text{C}$ . This is a simplified model but permit to make a parametric analysis about different factors in order to study the operation of the reactor.

As previously explained, due to the way of input the biomass in Aspen Plus, this model predicts the transition from elements constituting the biomass to products of gasification. According to this approach, a heat exchanger with the external is admitted in order to guarantee the fixed temperature, but it is neglecting the energy of formation (enthalpy of formation) of biomass (sludge).



In the adiabatic reactor, the enthalpy of formation of the compounds which constituted the biomass fed has been taken into account. In fact, feeding sludge as C, H, O and N is not equivalent to feeding complex chains of these elements; the real complex chain fed into the gasifier must be broken during the process engaging energy. This model predicts the transition from elements constituting the biomass to the biomass, and from biomass to products of gasification.

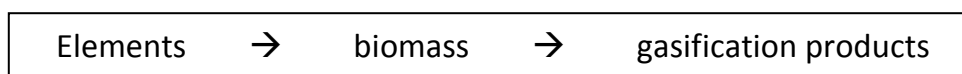

Biomass is usually characterized by *proximate analysis* and *ultimate analysis*. Proximate analysis quantified the solid-dry fraction and the humidity, on the dry fraction can distinguish the organic part from the ashes. Ultimate analysis provides the percentage of the main elements, on dry basis.

In this conditions, the operational characteristics and dried sludge fed characteristics are reported in the follow table:

Table 5.3: Sludge characteristics.

<i>Operational conditions: dried sludge</i>			
LHV sludge	9 MJ/kg	N (%)	8
T biomass	23 °C	O (%)	23
Pressure	1 atm	H <sub>2</sub> O/sludge	0.25
C (%)	58	CHNO/dry residual	0.52
H (%)	11	Ash/dry residual	0.45

This study has also provided a fed consisting of a mixture of sludge and agricultural biomass in different percentages, according to the configurations shown in figure 5.6 and 5.7:

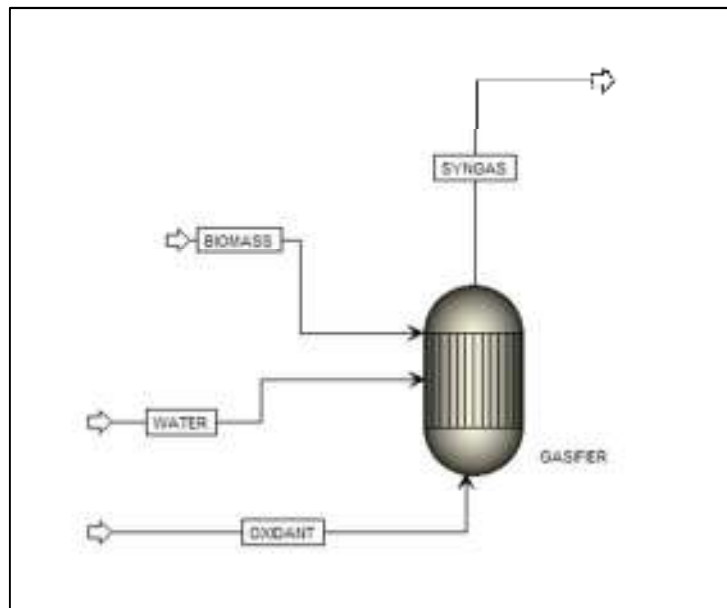

Figure 5.7: Scheme for simulation with feeding of agricultural biomass.

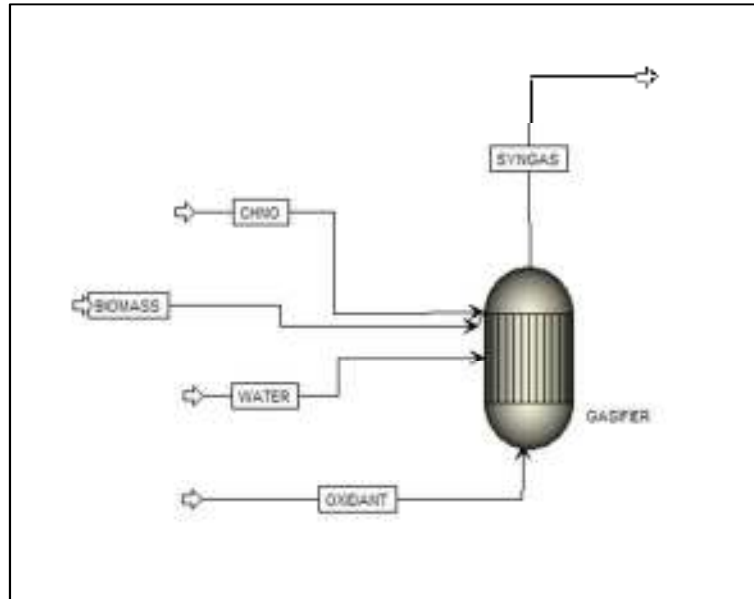

Figure 5.8: Scheme for simulation with feeding of a mixture of sludge and agricultural biomass.

## 5.6.1. Simulation results

### 5.6.1.1. Isothermal reactor

First simulations were done in the conditions of isothermal reactor with  $T=1,000^{\circ}\text{C}$  and assuming a relation air/biomass = 0.56 (500 kg/h). Calculations were carried out with a flow rate of 1,034 kg/h of dried sludge with a composition as follows:

Table 5.4: Composition of sludge.

<i>Operational conditions: dried sludge</i>			
C (kg/h)	241	O (kg/h)	96
H (kg/h)	46	H <sub>2</sub> O (kg/h)	258
N (kg/h)	33	Ash (kg/h)	360

Sludge composition was taken from Gestione Acqua SpA data available, with a humidity about 25% and 45% of ash. Temperature of sludge was assumed as environmental temperature that is  $23^{\circ}\text{C}$ .

After simulation, the syngas obtained presents a LHV of about  $7.89 \text{ MJ/Nm}^3$  and the following composition:



Table 5.5: Syngas composition obtained with isothermal reactor

<i>Syngas composition (Molar fraction)</i>			
Flow rate (Nm <sup>3</sup> /h)	1,615.17	Oxydant	air
CH <sub>4</sub>	31 PPM	O <sub>2</sub>	Trace
CO	0.252	NH <sub>3</sub>	19 PPM
CO <sub>2</sub>	0.026	NO <sub>2</sub>	Trace
H <sub>2</sub>	0.437	C <sub>2</sub> H <sub>2</sub>	Trace
H <sub>2</sub> O	0.079	C <sub>2</sub> H <sub>4</sub>	Trace
N <sub>2</sub>	0.206	C <sub>2</sub> H <sub>6</sub>	Trace

As it can be seen the syngas has a low LHV, but it is very rich in H<sub>2</sub> and practically do not present CH<sub>4</sub>. It is not expected char because all of carbon is gasified. Parametric analysis on the oxidant flow rate, the reactor temperature and the humidity of biomass have been done monitoring the molar fraction of the main components of the syngas obtained.

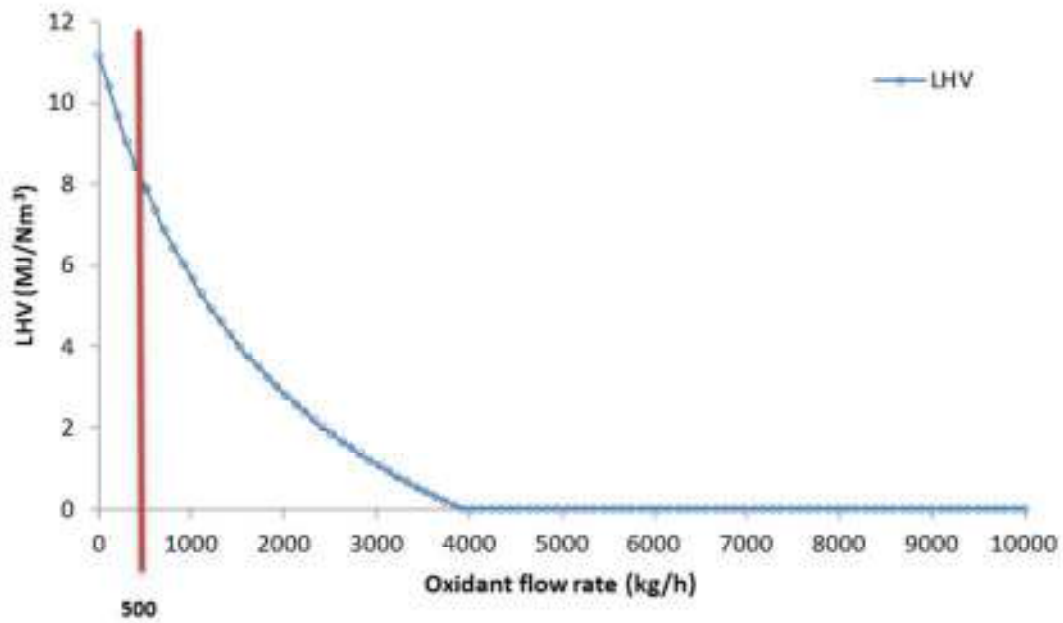

Figure 5.9: Parametric analysis on the LHV of syngas vs. oxidant flow rate.

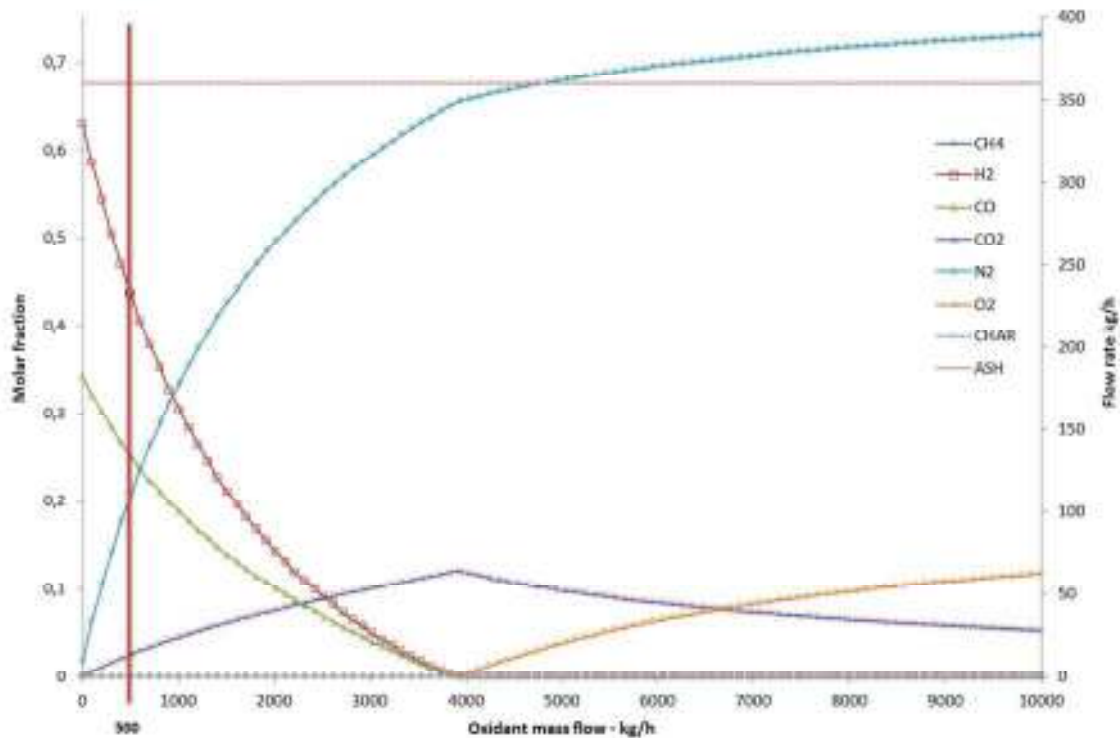

Figure 5.10: Parametric analysis on the molar fraction (primary axis for CH<sub>4</sub>, H<sub>2</sub>, CO, CO<sub>2</sub>, N<sub>2</sub>, O<sub>2</sub>) and mass flow rate (secondary axis for Char and Ash) vs. oxidant flow.

It can be seen in figure 5.9 that increasing the oxidant flow rate the LHV of syngas is reducing until be zero for complete combustion when the relation air /biomass is about 3.8, then, for this same value, oxygen begins to be detected in the syngas. Composition is gradually poorer in hydrogen when the oxidant flow rate is increasing, and it is rich on CO<sub>2</sub> and N<sub>2</sub>.

Ash is an element not reacting, but as previously mentioned, it is necessary to take account the energy necessary for their heating, moreover, it is an important element to evaluating in terms of feasibility of the technology.

The best value of LHV is in the absence of oxidant agent and hydrogen molar fraction reach the maximum value of 0.63.

Actually, the total gasification of carbon is influence also by the humidity. A parametric analysis about the humidity of sludge is shown in the following graphics.

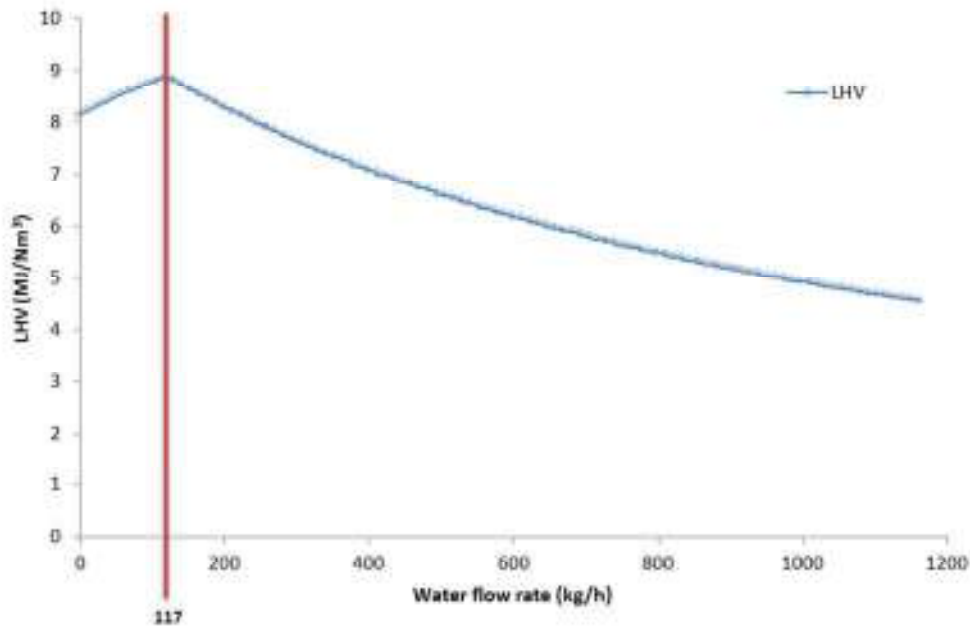

Figure 5.11: Parametric analysis on the LHV of syngas vs. humidity of sludge.

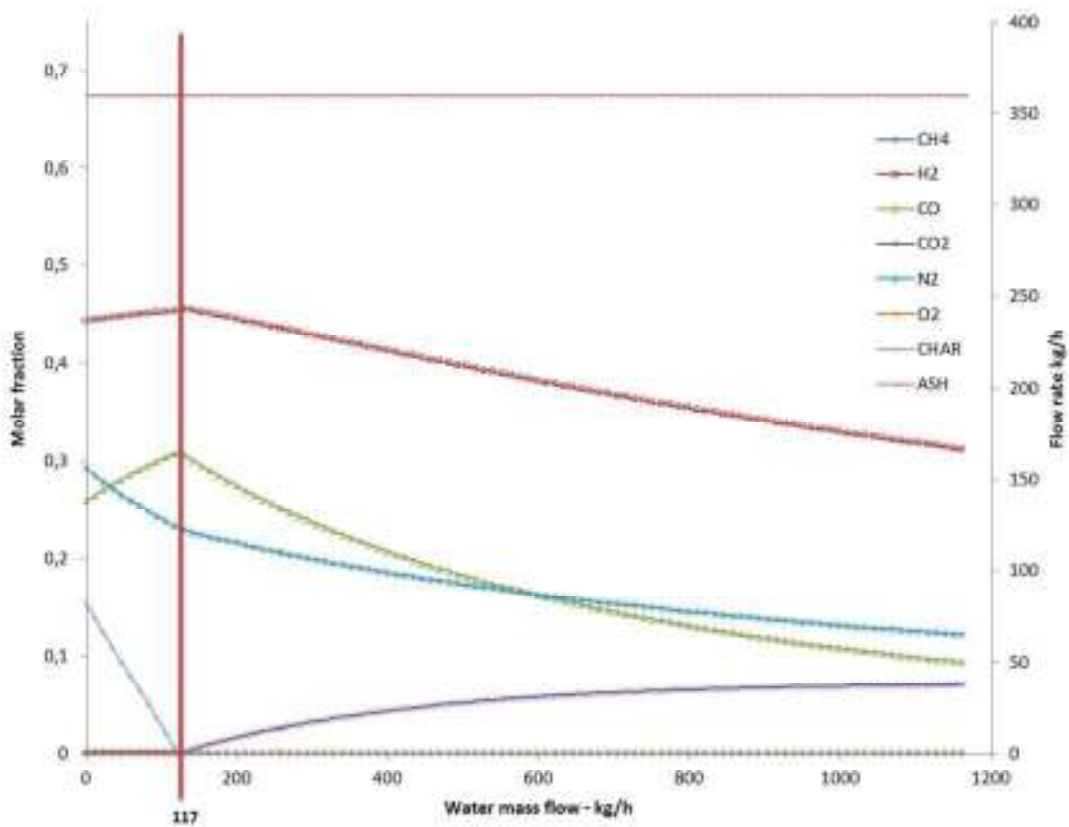

Figure 5.12: Parametric analysis on molar fraction (primary axis for CH<sub>4</sub>, H<sub>2</sub>, CO, CO<sub>2</sub>, N<sub>2</sub>, O<sub>2</sub>) and mass flow rate (secondary axis for Char and Ash) vs. humidity of sludge.

This analysis has been permitted to demonstrate that the humidity of 25% is not the optimal value, the ideal humidity of the sludge to be supplied is equal to 13.5% by weight, which is equivalent to a water flow rate of 117 kg/h. The parametric analysis was done until 60% of sludge humidity. It is evident the gradually dilution of syngas. Only CO<sub>2</sub> is

begins to notice for the optimal value of humidity. In this conditions, the best value for LHV was of 8.86 MJ/Nm<sup>3</sup>.

According to these results, it would be more convenient a pyrolysis operation without oxidant agent instead of gasification, however it is necessary to take account that the reactor is ideal and isothermal. In fact, this calculation is at the equilibrium and temperature is fixed equal to 1,000°C, and this is an operational constraint which imposes a significant energy exchange with the external. This flow provides heat to the system for lower oxidant flow rate and allows the endothermic reactions of pyrolysis and gasification. The flow assumes the opposite direction when the exothermic reactions of combustion prevails, and requires again heat from the external when the oxidant is feeding in excess and becomes an excess mass to be heated.

Additionally, parametric analysis about temperature of operation was done maintain the isothermal conditions.

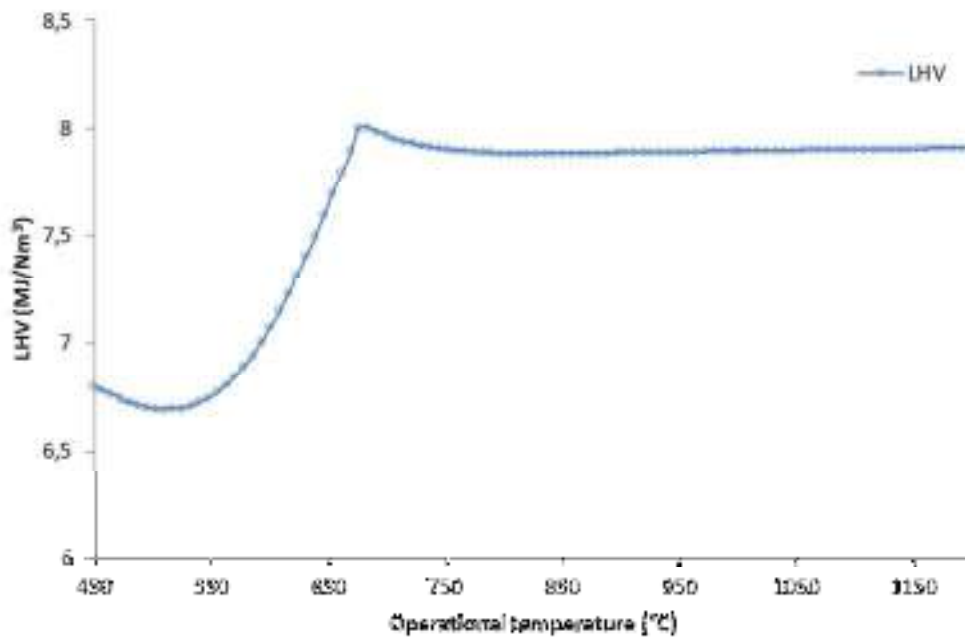

Figure 5.13: Parametric analysis on the LHV of syngas vs. operational temperature.

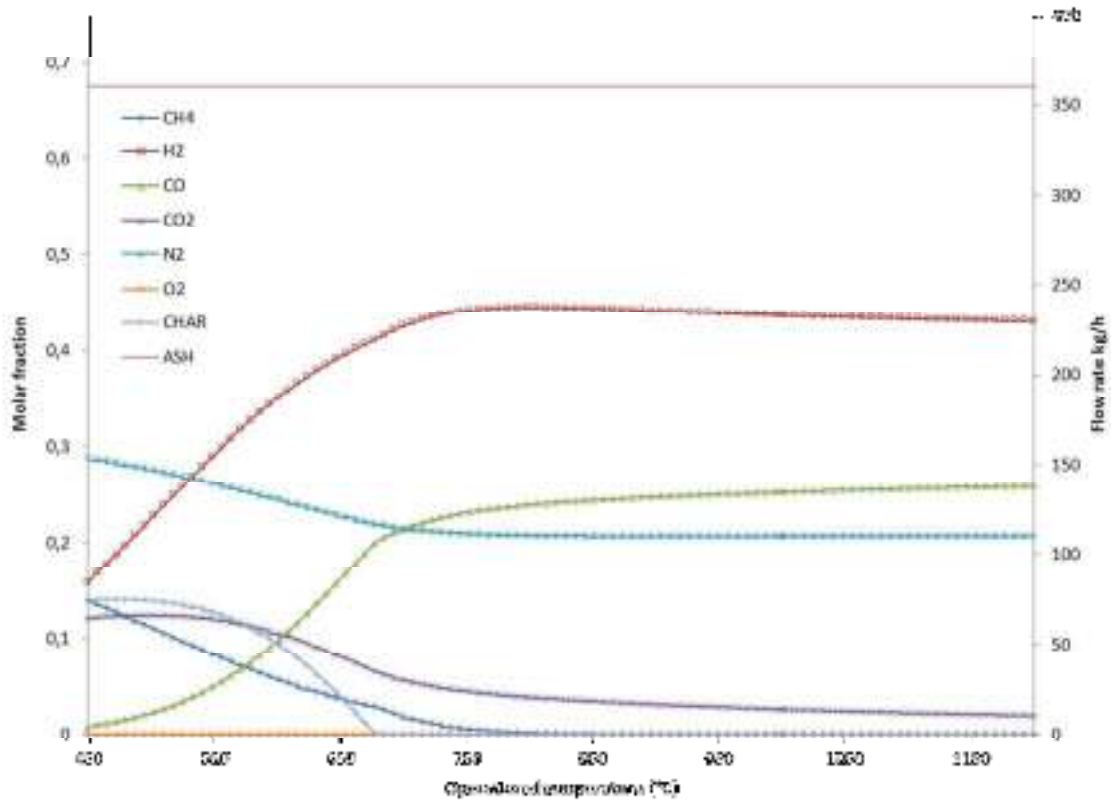
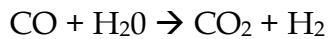

Figure 5.14: Parametric analysis on the molar fraction (primary axis for CH<sub>4</sub>, H<sub>2</sub>, CO, CO<sub>2</sub>, N<sub>2</sub>, O<sub>2</sub>) and mass flow rate (secondary axis for Char and Ash) vs. operational temperature.

This results in figure 5.12 show the LHV is improving when the temperature is increasing. In the range of 800 and 1,100°C the LHV is practically constant (7.88 MJ/Nm<sup>3</sup>), because is influenced by the LHV of H<sub>2</sub> and CO (see figure 5.13). Gasification operation takes place in that range of temperatures.

The amount of CO<sub>2</sub> is reducing according to the reaction *water – gas shift* which is not favorable for high temperatures in this direction:



Char is yet present when the temperature has values lower than 700°C, because not all the carbon is gasified and so it is present in the syngas, as well as methane for values lower than 700°C. But when temperature achieves about 700°C amounts of CO and H<sub>2</sub> are increasing, and oxygen is practically zero for any value.

In view of these results, the main conclusion for the isothermal reactor was that the optimal humidity of the biomass in order to be gasified is about 13.5% in weight. With the drier described previously is possible to get the humidity desired.

### 5.6.1.2. Adiabatic reactor

New simulations were carried out considering the real operation and the fact of pyrolysis and gasification reactions are on the whole process strongly endothermic. In this case an adiabatic model has been implemented which allows to estimate the operational conditions in which the system can guarantee an auto-thermal operation, taking into account the enthalpy of formation of biomass, calculated equivalent to 1,290.0 MJ/h.

With the same conditions employed in the isothermal reactor, the adiabatic reactor will operate to 483°C, then, the operational temperature of 1,000°C can be guarantee only with a heat contribution from the external, and even the reactor is exothermal it is necessary the heat contribution.

The calculation of the quantity of oxidant necessary in order to guarantee the operational temperature was done in Aspen through a design specification parameter, keeping fixed the temperature of oxidant on 23°C, and the results was equal to 1,960.0 kg/h. The LHV was 2.93 MJ/Nm<sup>3</sup>.

In this conditions the process is strongly endothermic, now the heat contribution can be attend on the oxidant flow rate, thus a parametric analysis on the temperature of oxidant was done, with the following results:

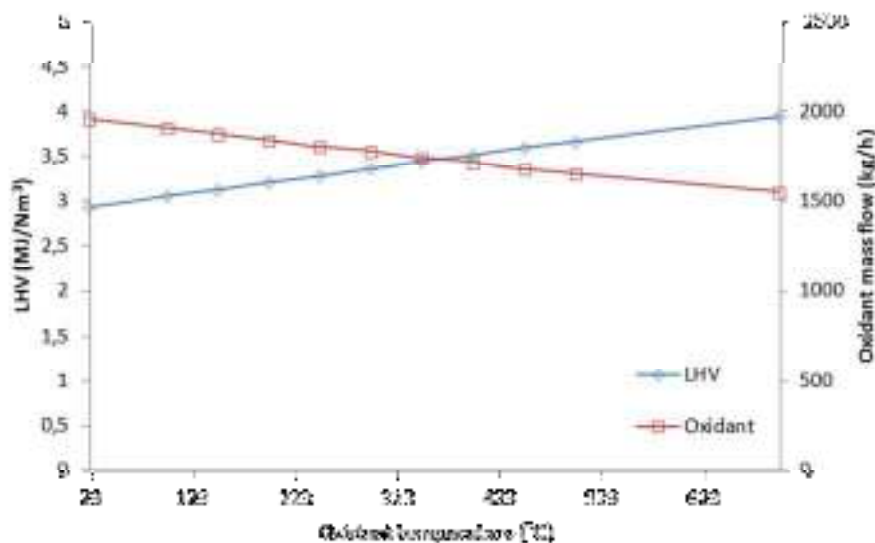

Figure 5.15: LHV of syngas (principal axis) and Oxidant mass flow (secondary axis) vs oxidant temperature.

It is note that an increasing of temperature involves a lightly increasing of LHV due to a lightly decreasing of the oxidant mass flow necessary. Evaluating the heat recovery available from exhaust gases, an air temperature of 450°C has been assumed and achievable in the following calculations.

Another parametric analysis about temperature of biomass and water in the input was done getting the following results.

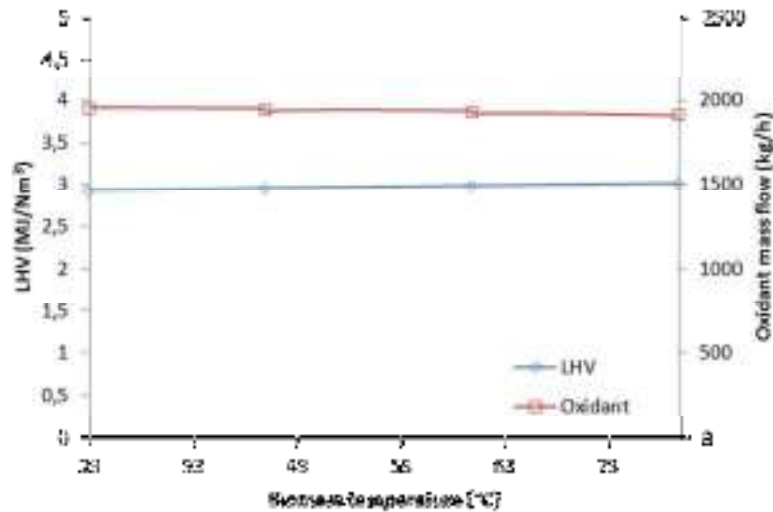

Figure 5.16: LHV of syngas (principal axis) and Oxidant mass flow (secondary axis) vs. biomass temperature.

The analysis was done until 80°C for biomass temperature, values greater than 80°C are not acceptable for heating biomass. The graphic show that the influence of biomass temperature on the inlet is not significant and it can be neglected the fact to heat the biomass.

At this point, keeping in mind the oxidant temperature (450°C) and the optimal humidity of sludge (13.5%), a parametric analysis on the oxidant flow rate for isothermal and adiabatic reactor was done so as to keep an operational temperature equal to 1,000°C.

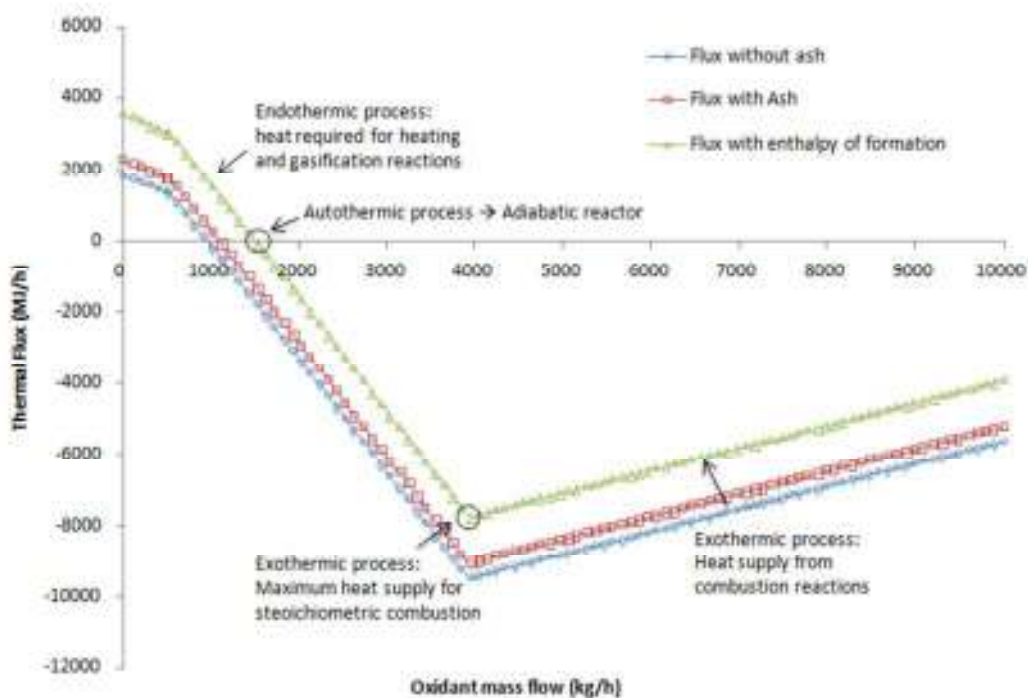

Figure 5.17: Thermal flux vs. oxidant flow rate so as keeping operational temperature of 1,000°C.

According to this graphic the oxidant flow rate is equal to 1,500.0 kg/h in an adiabatic reactor. In these conditions the syngas obtained has a LHV equal 4.47 MJ/Nm<sup>3</sup> with the following composition:

Table 5.4: Syngas composition from autothermal operation.

<i>Syngas composition (Molar fraction)</i>			
Flow rate (Nm <sup>3</sup> /h)	2012.66	Oxydant	air
CH <sub>4</sub>	2 PPM	O <sub>2</sub>	Trace
CO	0.170	NH <sub>3</sub>	10 PPM
CO <sub>2</sub>	0.049	NO <sub>2</sub>	Trace
H <sub>2</sub>	0.214	C <sub>2</sub> H <sub>2</sub>	Trace
H <sub>2</sub> O	0.106	C <sub>2</sub> H <sub>4</sub>	Trace
N <sub>2</sub>	0.460	C <sub>2</sub> H <sub>6</sub>	Trace

An analysis of inlet biomass temperature effect was done again considering the new conditions. The graphic in figure 5.17 shows also here that the inlet temperature of biomass is not having influence on the LHV of syngas or on the oxidant flow rate. In fact, both behaviors are practically constant.

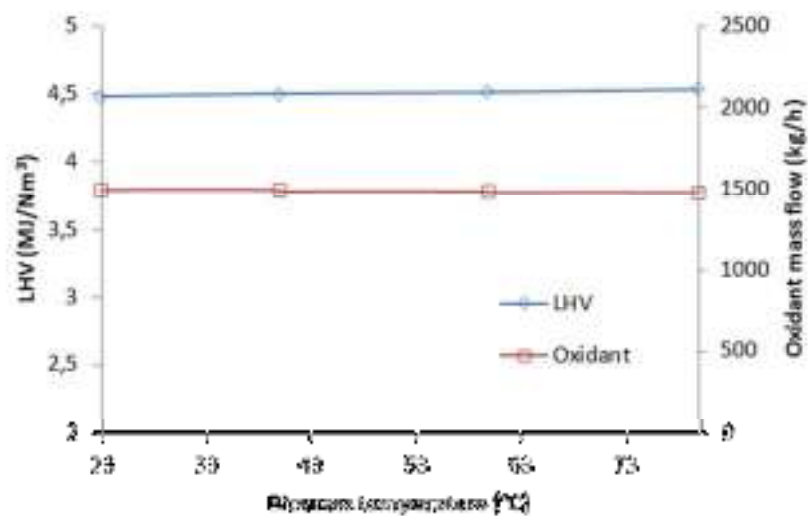

Figure 5.18: LHV of syngas (principal axis) and Oxidant mass flow (secondary axis) vs. biomass temperature.

A parametric evaluation about the amount of ash present in the biomass was carried out considering the last conditions.



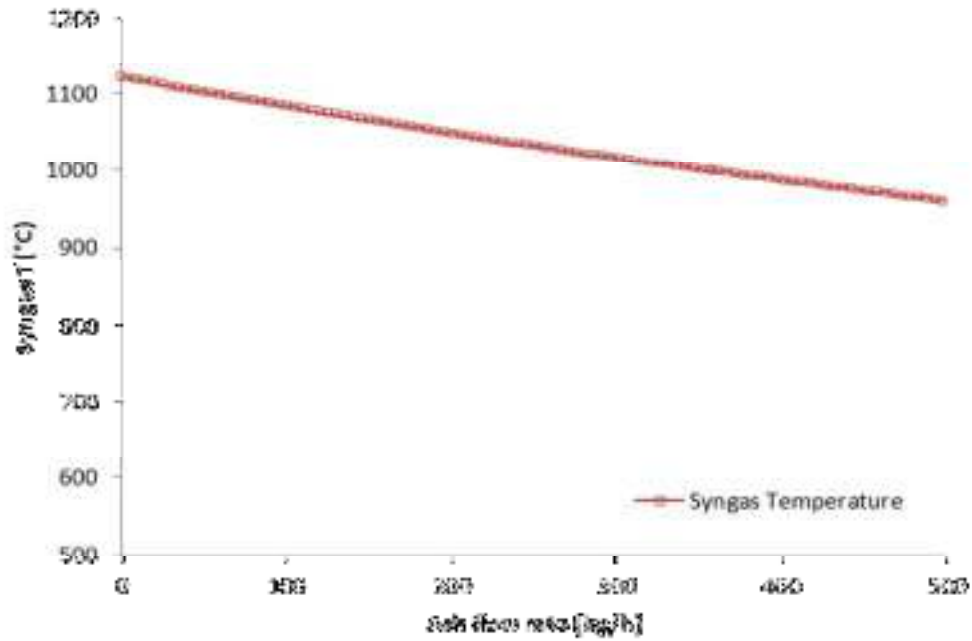

Figure 5.19: Parametric analysis on the syngas temperature vs. inlet ash flow rate.

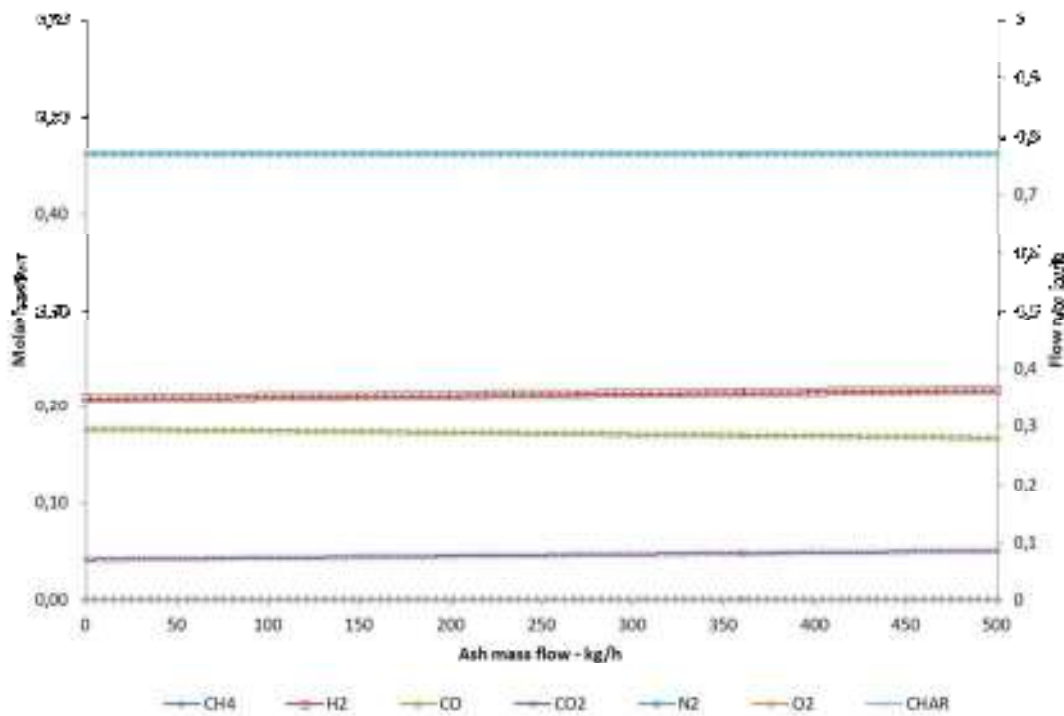

Figure 5.20: Parametric analysis on the molar fraction (primary axis for CH<sub>4</sub>, H<sub>2</sub>, CO, CO<sub>2</sub>, N<sub>2</sub>, O<sub>2</sub>) and mass flow rate (secondary axis for Char and Ash) vs ash flow rate.

The graphic 5.18 show that only operational temperature is being affected when ash flow rate is increasing.

Kinetic constraint is an important parameter for the gasification. Kinetic constraint is expressed as a quantity of carbon feeding which is not gasified, but remains as char. A first kinetic analysis was done through a parametric calculation about the amount of inert elements. The results are shown in the following graphics:

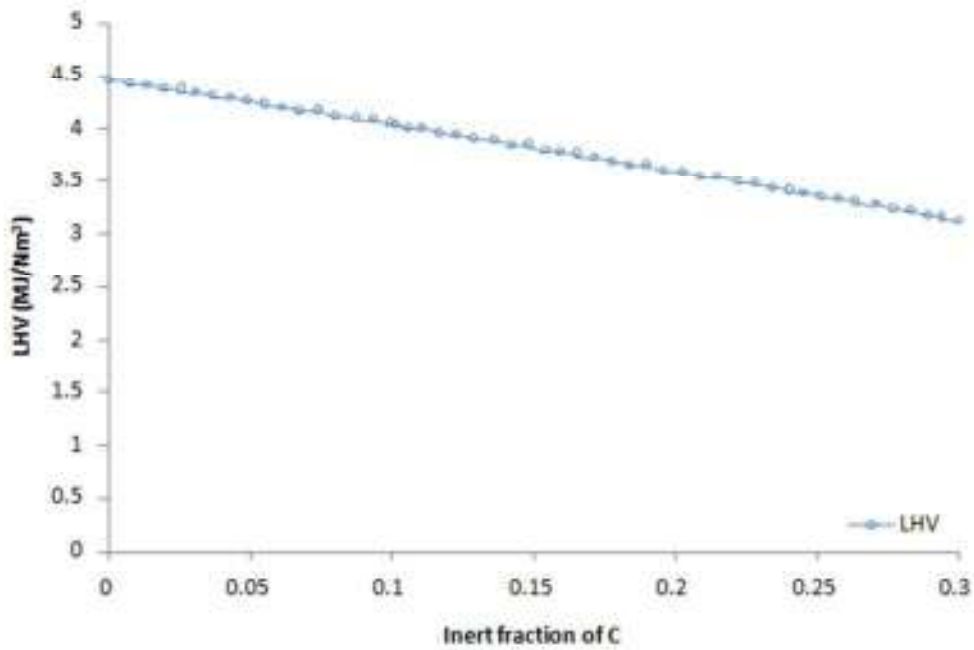

Figure 5.21: Parametric analysis on the LHV of syngas vs. inert fraction of C.

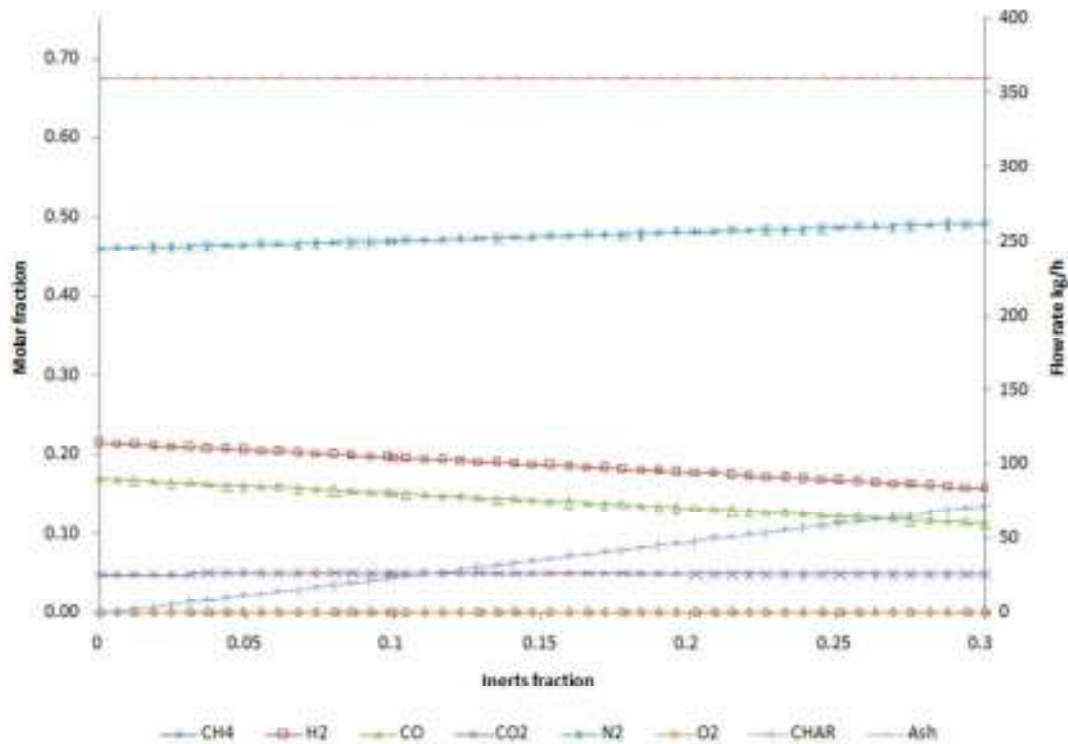

Figure 5.22: Parametric analysis on the molar fraction (primary axis for CH<sub>4</sub>, H<sub>2</sub>, CO, CO<sub>2</sub>, N<sub>2</sub>, O<sub>2</sub>) and mass flow rate (secondary axis for Char and Ash) vs. inert fraction of C.

The optimal situation is obviously when the kinetic constraints are not present, LHV achieve the best value of 4.47 MJ/Nm<sup>3</sup> as previously calculated. And all char is gasified. As the inert fraction of C is increasing, the syngas becomes poorer on H<sub>2</sub> and CO, while N<sub>2</sub> is lightly increasing as well as the amount of char.

In this way, an accurate simulation of this system is actually taking account the kinetics of the reactions which are having being place during gasification. Next paragraph will explain this new situation.

### 5.6.1.3. Adiabatic reactor considering the kinetic constraints

Based on the literature, it has been assuming a model with 15% of the carbon fed is not gasified, and it results in output in the way of char (36.15 kg/h).

The optimal operational condition and characteristics of biomass until now founded for an operational temperature of 1,000°C are summarized in the following tables:

Table 5.7: New operational conditions and characteristics of sludge.

<i>Operational conditions: dry sludge</i>			
LHV sludge	9 MJ/kg	N (%)	8
T biomass	23 °C	O (%)	23
T oxidant	450°C	Inerts	0.15
Pressure	1 atm	H <sub>2</sub> O/sludge	0.14
C (%)	58	CHNO/ dry residual	0.52
H (%)	11	Ash/ dry residual	0.45

Table 5.8: Composition of sludge.

<i>Operational conditions: dry sludge</i>			
C (kg/h)	241	O (kg/h)	96
H (kg/h)	46	H <sub>2</sub> O (kg/h)	117
N (kg/h)	33	Ash (kg/h)	360

For these new parameters, a new oxidant flow rate was calculated; the calculations gave a result of about 1,360.0 kg/h and a LHV of 4.24 MJ/Nm<sup>3</sup>. The syngas obtained has the following composition:

Table 5.9: Composition of syngas.

<i>Syngas composition (Molar fraction)</i>			
Flow rate (Nm <sup>3</sup> /h)	1,890.9	Oxydant	air
CH <sub>4</sub>	1 PPM	O <sub>2</sub>	Trace
CO	0.150	NH <sub>3</sub>	10 PPM
CO <sub>2</sub>	0.051	NO <sub>2</sub>	Trace
H <sub>2</sub>	0.217	C <sub>2</sub> H <sub>2</sub>	Trace
H <sub>2</sub> O	0.128	C <sub>2</sub> H <sub>4</sub>	Trace
N <sub>2</sub>	0.453	C <sub>2</sub> H <sub>6</sub>	Trace

According to the literature [Aiello et al, 2010] [Judex et al, 2012] [Schuster, 2001], the LHV of syngas from gasification of sewage sludge is ranging from 2 to 7 MJ/Nm<sup>3</sup>.

#### 5.6.1.4. Gasification of sewage sludge with agricultural biomass.

In view of the poorness of the products obtained with the previous simulations, it was carried out new simulations considering a feedstock as a mixture of dried sewage sludge with agricultural biomass in diverse proportions, with the aim of improving the syngas quality. The simulation schemes were presented according to figure 5.6 and 5.7.

A general composition of agricultural biomass is indicated in the following table:

Table 5.10: Agricultural biomass composition and operational conditions

<i>Operational conditions: agricultural biomass</i>			
LHV	18 MJ/kg	N (%)	0.2
T biomass	23 °C	O (%)	44.4
Pressure	1 atm	H <sub>2</sub> O/sludge	0.12
C (%)	49.4	CHNO/dry residual	0.96
H (%)	6	Ash/dry residual	0.01

Calculations took account the enthalpy of formation of agricultural biomass which results of about 2,062.0 MJ/h.

Considering a feedstock only by biomass, through an adiabatic reactor, considering the enthalpy of formation of agricultural biomass, with an inlet oxidant temperature of 450°C, it was calculated the oxidant flow rate necessary in order to guarantee the operational temperature of the gasifier at 1,000°C. The calculations permit to achieve an oxidant flow rate of about 790 kg/h and syngas has a LHV of about 6.74 MJ/Nm<sup>3</sup>, which is greater than the LHV of only sludge gasification. The syngas composition of feeding only biomass is shown in the follow table:

Table 5.11: Composition of syngas from only biomass gasification.

<i>Syngas composition (Molar fraction)</i>			
Flow rate (Nm <sup>3</sup> /h)	1,751.7	Oxydant	air
CH <sub>4</sub>	0.1 PPM	O <sub>2</sub>	Trace
CO	0.295	NH <sub>3</sub>	0.1 PPM
CO <sub>2</sub>	0.056	NO <sub>2</sub>	Trace
H <sub>2</sub>	0.28	C <sub>2</sub> H <sub>2</sub>	Trace
H <sub>2</sub> O	0.092	C <sub>2</sub> H <sub>4</sub>	Trace
N <sub>2</sub>	0.277	C <sub>2</sub> H <sub>6</sub>	Trace

A study about the gasification of the mixture of sludge and agricultural biomass was done considering different percentages of agricultural biomass. The calculations were done in the base of 895 kg/h of total biomass fed. Sludge has humidity about 13.5% on

weight and biomass has humidity about 12 % on weight. Oxidant is feeding at 450°C. For each mixture composition, the amount of oxidant was calculated so as ensure 1,000°C operational temperature. All calculations were done in an adiabatic reactor and the enthalpy of formation was calculated for any case. The total biomass fed composition is shown in the table:

Table 5.12: Characteristics of sludge and biomass fed.

<i>Percentage of agricultural biomass fed</i>	<i>Sludge</i>			<i>Agricultural biomass</i>		
	<i>Mixed (kg/h)</i>	<i>Solid (kg/h)</i>	<i>Water (kg/h)</i>	<i>Mixed (kg/h)</i>	<i>Solid (kg/h)</i>	<i>Water (kg/h)</i>
0%	174.6	601.4	117.1	0.0	0.0	0.0
10%	157.1	541.3	106.2	39.7	38.9	10.7
30%	122.2	420.9	82.61	119.1	116.7	32.1
50%	87.3	300.7	59.0	198.5	194.5	53.6
70%	52.38	180.42	35.4	277.8	272.3	75.0
90%	17.46	60.1	11.8	357.2	350.2	96.4
100%	0.0	0.0	0.0	396.9	389.1	107.2

Considering these conditions, the table shows the variation of oxidant flow rate, syngas flow rate, enthalpy of formation and LHV for any percentage of agricultural biomass fed.

Table 5.13: Parametric analysis for mixtures of sludge and agricultural biomass

<i>Percentage of agricultural biomass fed</i>	<i>Oxidant flow rate (kg/h)</i>	<i>Syngas flow rate (Nm<sup>3</sup>/h)</i>	<i>Enthalpy of formation (MJ/h)</i>	<i>LHV (MJ/Nm<sup>3</sup>)</i>	<i>H<sub>2</sub> mole fraction</i>
0%	1,359.0	1,898.9	-1,290.1	4.24	0.217
10%	1,301.5	1,883.7	-1,367.2	4.46	0.224
30%	1,178.9	1,848.2	-1,521.6	4.95	0.238
50%	1,056.8	1,812.9	-1,676.0	5.45	0.252
70%	934.8	1,777.2	-1,830.4	5.98	0.266
90%	814.7	1,743.7	-1,984.8	6.52	0.276
100%	789.0	1,751.7	-2,061.9	6.74	0.280

The following graphics show the quality of syngas is improving when the percentage of biomass is increasing in the mixture. LHV and molar fraction of H<sub>2</sub> of the syngas are increasing. LHV reaches the best value of 6.74 when the mixture is only agricultural biomass. The syngas flow rate is lesser when the feeding was only biomass, but also the amount of oxidant fed to the gasifier is less according to the calculation for any case in order to maintain the operational temperature.

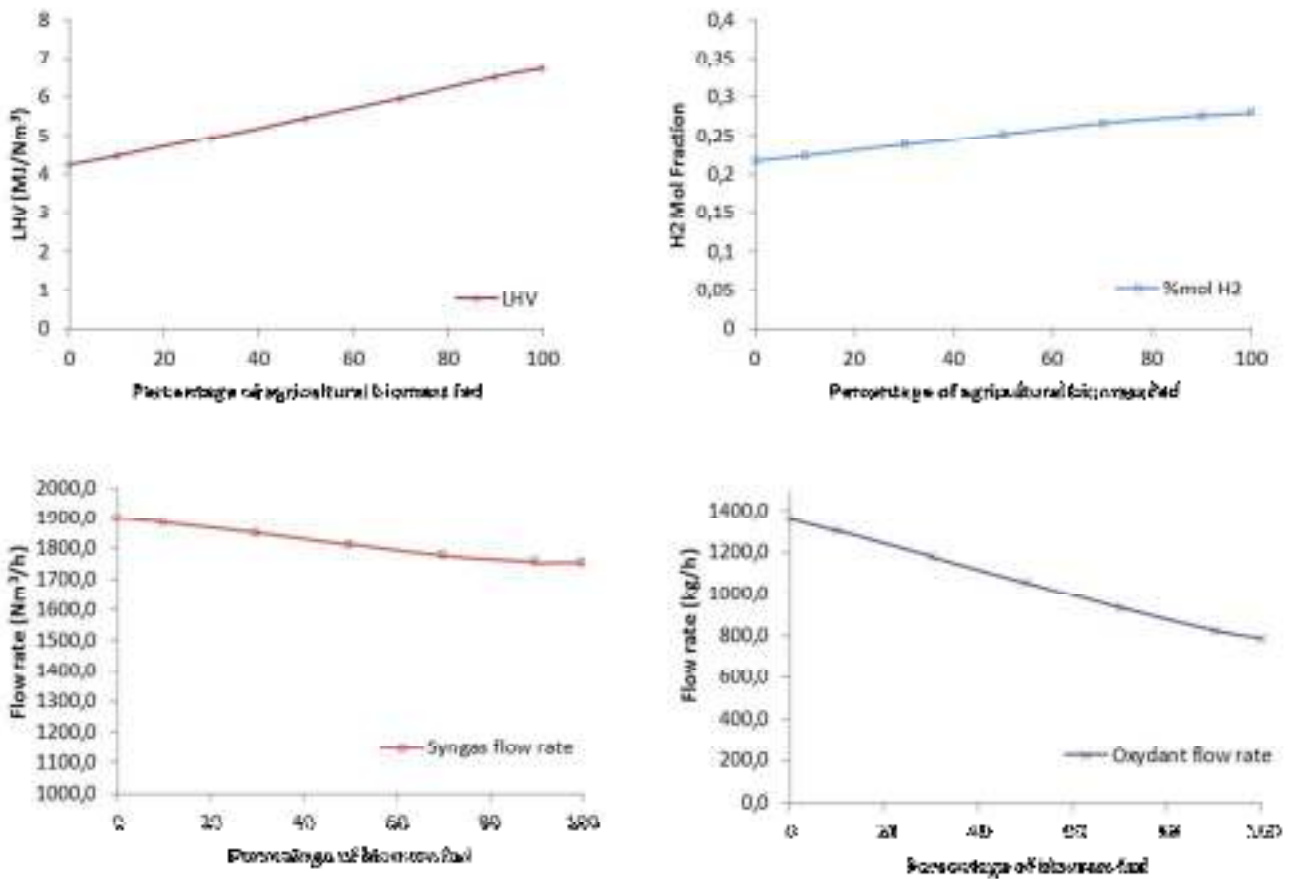

Figure 5.23: Variation of LHV, H<sub>2</sub> molar fraction, syngas flow rate and oxydant flow rate for any percentage of agricultural biomass fed.

When the mixture has 50% of sludge and 50% of agricultural biomass, the LHV of syngas is about 5.5 MJ/Nm<sup>3</sup>, and shows the following composition.

Table 5.14: Composition of syngas from 50% of sludge and 50% of biomass.

<i>Syngas composition (Molar fraction)</i>			
CH <sub>4</sub>	4 PPM	O <sub>2</sub>	Trace
CO	0.217	NH <sub>3</sub>	11 PPM
CO <sub>2</sub>	0.056	NO <sub>2</sub>	Trace
H <sub>2</sub>	0.252	C <sub>2</sub> H <sub>2</sub>	Trace
H <sub>2</sub> O	0.111	C <sub>2</sub> H <sub>4</sub>	Trace
N <sub>2</sub>	0.365	C <sub>2</sub> H <sub>6</sub>	Trace

In view of these results, in term of quality and quantity of syngas, this solution could be not preferable.

## 5.7. Discussion

A particular point for attention is the high ash content present in the sludge. This involves especially technical difficulties and the problem of disposal. Ashes can be used as reusable materials for the production of concrete, use on brick industries, production of compost, fertilizers and environmental recovery. However, there are problems regarding the characteristics of ashes and the requirements for the management of recovery and supply. Characteristics of ashes can involve problems about quality, quantity and environmental impact costs.

This aspect is a constraint for the choice of the technology. It is suggested the use of reactors with the combustion chamber at a temperature sufficiently high to allow the fusion of the ash and their complete inerting.

Furthermore, the presence of undesired substances in the syngas forces to consider a section of clean-up and depending of the final use of syngas. Currently, the process allows purification solutions at elevated temperature avoiding cooling the syngas to clean it and then heating again for its use in systems of electricity production with consequent loss of energy efficiency of the plant. Tar also can cause problems in process equipment as well as in engines and turbines. The quantity of tar is strongly dependent on the process and final user applications.

Regarding the oxidant agent other solutions are possible which avoid syngas dilution by  $N_2$ : the use of steam, which enhance endothermic reforming reactions that cause a temperature decrease in the reactor. The use of oxygen, which can increase the calorific value of syngas, but is economically not convenient.

As previously said, gasification has many advantages, additionally to them already mentioned, gasification destroys pathogenic bacteria, involves low emission-control costs and permits energy recovery.

This chapter studied a preliminary feasibility analysis with simplified simulation model in order to verify whether the sludge could be gasified, to highlight the main technological problems and to establish the bases for the choice of the reactor type and the process details.

The model based on concentrated parameters neglecting the local analysis, and as the reaction mechanism were complex and the components of the inlet sludge were known only in terms of element composition, a non-stoichiometric model was chosen. The outlet syngas characteristics were evaluated with Gibbs free-energy reactor model. An isothermal and an adiabatic reactor were implemented, where the operational temperature was fixed at  $1,000^\circ\text{C}$  for isothermal reactor and maintained to  $1,000^\circ\text{C}$  for adiabatic reactor varying oxidant flow rate.

The syngas obtained has a LHV of about  $4.24 \text{ MJ}/\text{Nm}^3$  which is an acceptable value compared to other values found in the literature. The parametric analysis made for any case studied demonstrated that an optimal humidity of biomass (dried sludge) must be

lower than 20%. The inlet temperature of biomass not affect significant the quality of syngas, but the inlet temperature of oxidant could be an important factor, in fact it would be heating until 450°C.

Ash not limited the energy potential of sludge but cause technical problems during its processing and represents a significant term in the thermal balance, because it requires additional energy for its warming.

An analysis of a feedstock with sludge and residual agricultural biomass was done. It was observed that the quality of syngas is improved. A good combination could be a mixture with 50% of sludge and 50% of agricultural biomass. This solution could represent a good alternative in terms of syngas quality, environmental impact and integrated territorial policies for both countries involves along this doctoral thesis. Italy and Peru base their economic matrix on the agriculture, and nowadays the problem of residual discharge from agro-industries is a great and need to be considerate, especially in Peru.



## **CHAPTER 6: FINAL CONSIDERATIONS**

### **6.1. Total energy production**

Total energy production can be calculated including the results obtained for anaerobic digestion and gasification of sewage sludge.

Biogas obtained from anaerobic digestion in the UASB reactors has a very high methane content, calculations demonstrate that biogas has a LHV equivalent to 21 MJ/m<sup>3</sup>. Then, the amount of energy generated is potentially 0.42 MW which could satisfy the plant's energy demands or elsewhere.

Syngas obtained from gasification of only sewage sludge has a LHV of about 4.24 MJ/Nm<sup>3</sup> rich on hydrogen. Considering power generation in a conventional engine fuel, the final energy production is approximately 0.55 MW for about 1,000 kg/h of sludge feedstock.

Hypothesizing to design and built this sustainable plant for the case study of Chiclayo city (Peru), the total amount of sludge produced by day is about 2,852.7 kg/d with about 86.5% of water content, then, 385.0 kg/h after drying can be obtained. Applying gasification processes and fuel engines with 25% of efficiency, it can produce about 0.21 MW.

The total energy production would be about 2,252 MJ/h equivalents to 0.63 MW.

### **6.2. Summary of the work and conclusions**

This doctoral thesis has been developed considering the Italian context as important reference one and transferring the results acquired to the Peruvian framework.

A comparison between different kind of wastewater treatment plants in Europe and Latin America has been done considering three main examples: Novi Ligure (Italy), Bucaramanga (Colombia) and Chiclayo (Peru); all of them treating domestic wastewaters. The results of this analysis have demonstrated the differences regarding technology, cultural and economic aspects; particularly in developing countries the low investments constitute the main barrier to get more advance treatment processes.

It was analyzed a sustainable proposal of large - scale wastewater treatment plant in a Peruvian community with the aim of improving the current treatment, recovering of by-products and reusing the treated effluents. The proposal solution was the combination of stabilization ponds with UASB reactors.

It was describe three lines of treatment (sewage, biogas and sludge treatment) and compare current efficiencies with those calculated for the new scheme proposed. Each step of the proposal has been analyzed since the entrance of water until the final discharge of water. Preliminary treatment has been improved. Afterwards, applying 5 UASB reactors

with 18 modules each, each reactor with a treatment capacity of 2,852 m<sup>3</sup>/h , a 3,360 m<sup>3</sup> volume and a 6 hour Hydraulic Retention Time.

The reactor has removal efficiencies of approximately 71%; 64%; 90% for, respectively, BOD<sub>5</sub>, COD and Faecal Coliform; while the entire system proposed (UASB + Stabilisation ponds) can achieve removal efficiencies of about 91%, 64% and 99.9% for, respectively, BOD<sub>5</sub>, COD and Faecal Coliform. Figure 6.1 demonstrates the reduction of the concentrations for each parameter studied from the input to the output of the plant.

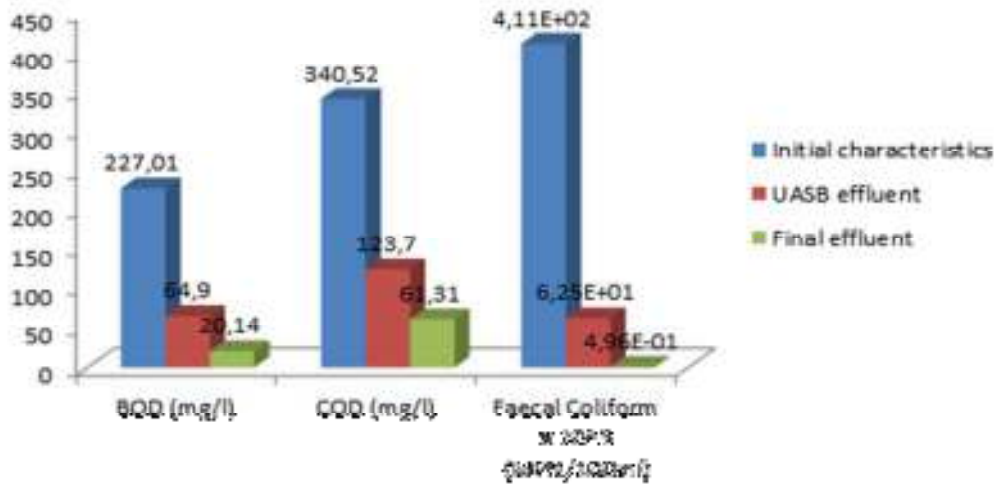

Figure 6.1. Initial and final effluents concentrations.

These results, compared with current removal efficiencies of approximately 65% BOD<sub>5</sub> and 90% Faecal Coliforms (see figure 6.2.), demonstrate that final effluents have the appropriate characteristics for recycling, compliant with the requirements of Peruvian law for waste treatment and disposal.

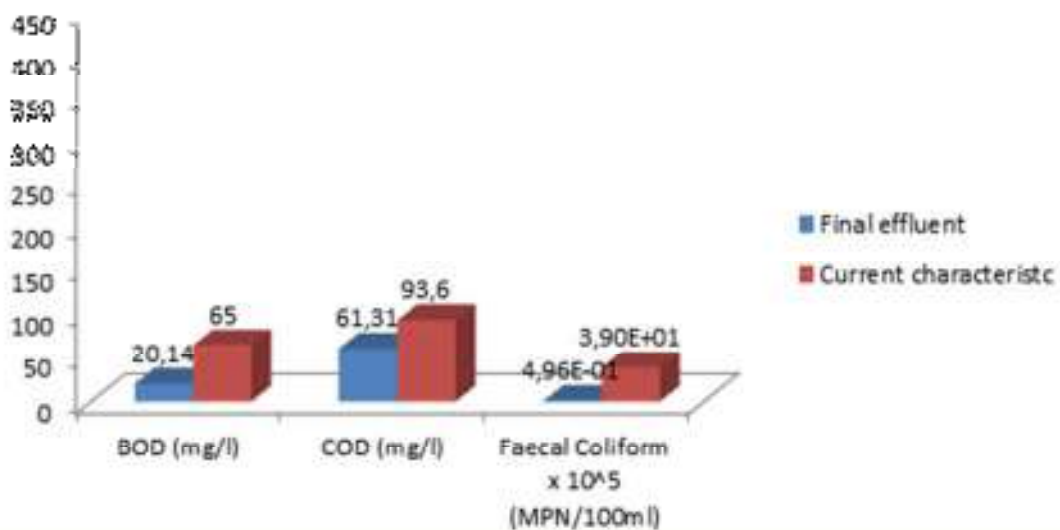

Figure 6.2. Comparison between final concentration achieved with this proposal and current final concentrations.

These results were presented at the Fourth International Symposium on Energy from Biomass and Waste (VENICE 2012) in an article titled: "Large-scale Up-flow Anaerobic Sludge Blanket (UASB) for energy production in a Peruvian community, with authors: Z.B. Chavez Romero, J.L. Colonia Huertas, B. Bosio, E. Arato.

One of the main goal of this research involves the recovery of sewage sludge. A foreign research activity in the University of Nevada, Reno from January to June 2012 at the department of Chemical and Materials Engineering under the supervision of Prof. Charles Coronella was carried out. Experimental and simulated activities were done in order to measure the diffusion moisture coefficient in dewatered sludge as a pretreatment step of drying sludge for successive energy recovering.

The thermal drying of sludge was studied at 50°C. Samples for experimental activity were obtained from sewage treatment of city of Reno (NV). Mathematically, the drying process was studied using the Fick's law of diffusion and a model proposed by Font et al (2011) for the diffusion coefficient calculation. The last model was a particular function of moisture content and two correlation parameters, the methodology followed was the optimization of Font's parameters in order to get more accurate results respect to the experimental data obtained for this case.

Using non-linear regression techniques, new parameters were find. The average errors for each position studied in the sludge layer examined were 2.51%, 2.50%, 4.28% and 25.35%, from the surface to the bottom, with an average error of about 8.66%; while the diffusion coefficient values found were varying from  $1.34 \times 10^{-11}$  for moisture content about 5.5 kg water/kg d.s. to  $8.58 \times 10^{-10}$  for moisture content about 0.82 kg water/kg d.s. Acceptable correlations have been obtained for the variation between experimental and simulated data.

Gasification process was chosen as the energy valorization system for complete this research. A model based on concentrate parameters, at the thermodynamic equilibrium and/or semi-empirical, non-stoichiometric was defined. The outlet syngas characteristics were evaluated with Gibbs free-energy reactor model. An isothermal and an adiabatic reactor were implemented, where the operational temperature was fixed at 1,000°C for isothermal reactor and maintained to 1000°C for adiabatic reactor, moreover the enthalpy of formation of biomass and kinetic constraints were also considered. The syngas obtained has a LHV of about 4.24 MJ/Nm<sup>3</sup>.

In this way, this research evaluated an integrate solution for the problem of wastewater treatment and energy valorization of products.

### **6.3. Future developments**

Regarding the plant proposal discussed in the third chapter which concerns the adaptation of a Peruvian treatment plant, a more civil and architectural engineering design would be done, mainly with the aim to introduce this proposal to the competent

authorities and/or private services companies in order to discuss the viability of doing reality.

Concerning the optimization of parameters and the mathematical model of diffusion coefficient discussed in chapter 4, new non-linear multivariable optimization methods would be implemented in order to achieve a more accurate minimization of the objective function for our specific drying sludge experiments.

Additional proximate and ultimate analysis about diverse kind of sludge would need to be done, it was useful especially from UASB reactors in order to evaluate in a better way the quality of syngas obtained in a UASB wastewater treatment plant with energy valorization of sewage sludge. Even if the experimental data for gasification process simulation were available by Gestione Acqua SpA, further analysis on the sludge characteristics must be beneficial.

Furthermore, this work can be ongoing with the simulation of a whole gasification process flow sheet considering both cases of feedstock: sludge and a mixed with agricultural biomass. In addition, other kinetic parameters must also be considered, this fact will allow to have results even more close to the reality and so a better evaluation about the feasibility of the project.

Finally, PERT<sup>33</sup> research group from DICCA<sup>34</sup> of the University of Genoa is developing a pilot-scale gasification plant with application of an innovative Spouted bed gasifier in Biella (town in the northern Italian region of Piedmont), where it will be possible to realize experimental tests. In this case, characteristics of sludge from Italian treatment plants will be strongly necessary.

## 6.4. References

- Agenda Local 21 Chiclayo, "*Diagnóstico de la Gestión de la Red de Agua y Alcantarillado GRAA*," Sistema de información de la gestión ambiental de Chiclayo - Universidad Señor de Sipán, Chiclayo, Peru, Advance 2006.
- Aiello M, Bacchi D, Bellini A, Puccini M, Seggiani M, Vitolo S, *Sewage sludge gasification in a Pilot scale plant*. Venice 2010, Third International Symposium on Energy from Biomass and Waste. (In proceedings).
- Alcaldia de Bucaramanga, "*Bucaramanga's metropolitan area and GHG reduction*," CIDEU - Ciudades de la SURBRED ANDINA, Medellin, Power point presentation 2007.
- Akella A, Saini R and Sharma M, "*Social, economical and environmental impacts of renewable energy systems*," *Renewable energy*, no. 34, pp. 390 - 396, September 2008.
- Arena A, Liberal V and Cuevas C, "*Eficiencia de remoción de bacterias coliformes en un sistema UASB y lagunas de maduración*," *Avances en energías renovables y Medio Ambiente*, vol. 9, pp. 43 - 47, 2005.

---

<sup>33</sup> PERT is the acronym for Process Engineering Research Team.

<sup>34</sup> DICCA is the Italian acronym for Dipartimento di Ingegneria Civile, Chimica e Ambientale.

- Arroyo M, Mendoza P, Jimenez W, and Ruiz W, *Viability analysis from a hydro system for the sustainable energy vector production*, 2005, Article presented to Encuentro Científico Internacional. Lima, Peru.
- Azimi A and Zamanzadeh M, "Determination of design criteria for UASB reactors as a wastewater pretreatment system in tropical small communities," *Int. J. Environ. Sci. Tech.*, vol. 1, no. 1, pp. 51 - 57, 2004.
- Bellur S, Coronella C, and Vasquez V., "Analysis of biosolids equilibrium moisture and drying," *Environ. Prog. Sustain. Energy*, vol. 2, no. 28, pp. 291 - 298, 2009.
- Bonomo L, *Trattamenti delle acque reflue*, First edition ed. Milan, Italy: McGraw-Hill, 2008.
- Bosio B, Serrafiero A, Arato E. *Methane steam reforming in MCFC power plants fed with biomass-derived fuels*. AIDIC. pp. 719 - 724. 2005.
- Bosio B. *Attività di ricerca e supporto specialistico per lo "Studio della valorizzazione energetica di biomasse agricole e derivanti da depurazione di reflui civili ed industriali"*. Contratto di ricerca 2006 AMIAS/DIAM (Pert). Document. Genova, Italy. 2006.
- Braatz S S and Kandiah A, "The use of municipal waste water for forest and tree irrigation," *An international journal of forestry and forest industries*, vol. 47, no. 185, February 1996.
- Carrillo R and Frei C, "Water: A key resource in energy production," *Energy Police*, vol. 37, no. 11, pp. 4303 - 4312, November 2009.
- Cavalcanti P, "Integrated application of the UASB reactor and ponds for domestic sewage treatment in tropical regions," University of Wageningen , Wageningen, Doctoral thesis 90-5808-819-9, 2003.
- CEPIS/OPS, "Guia para el diseño de tanques de sedimentación, tanques Imhoff y Lagunas de estabilización," CEPIS - OPS, Lima, Technical 2005.
- Chan Y, Chong M, Law C, and Hassell D, "A review on anaerobic - aerobic treatment of industrial and municipal wastewater," *Chemical engineering journal*, vol. 155, no. 2, pp. 1- 18, December 2009.
- Chamy R, *Avances en biotecnología ambiental: tratamiento de residuos líquidos y sólidos*, Second edition ed. Valparaíso, Chile: Ediciones universitarias de Valparaíso, 2003.
- Chavez Z, "Generación de electricidad a partir de las aguas residuales de Chiclayo," Universidad Católica Santo Toribio de Mogrovejo, Chiclayo, Perú, Tesis de pregrado 2009.
- Chun W, Lee K, "Sludge drying characteristics on combined system of contact dryer and fluidized bed dryer", *IDS - 14 th International Drying Symposium*, 2004. vol. B, pp. 1055 - 1061 (in proceedings).
- Cleverson A, Von Sperling M and Fernandes F, *Biological wastewater treatment: Sludge treatment and disposal*, First Edition ed. New Delhi, India: IWA Publishing, 2007.
- Coronella C and Vasquez V, *System and method for energy production from sludge*. United States patent application publication. Patent Number US 2010/0043445 A1. Reno (USA). 2010.
- Coronella C. Vasquez V, "A simple model for Vapor-Moisture equilibrium in biomass substrate," *Wiley Interscience*, vol. 55, no. 6, pp. 1595 - 1603, 2009.
- Da Cámara L, Hernández M, and Paz L, "Manual de diseño para plantas de tratamiento de aguas residuales," Facultad Regional Bahía Blanca. Universidad Tecnológica Nacional, Buenos Aires, Argentina, Miniproyecto de Ingeniería Química.
- De Lemos C, *Biological wastewater treatment: Anaerobic reactors*, 1st ed. New Delhi, India: IWA Publishing, 2007.
- Del Buono, Bosio, B. *Sewage sludge thermochemical valorisation*. HYSYDays - 2nd World Congress of Young Scientists on Hydrogen, Torino, 2007. (in proceedings)

- Donaires T, "Un nuevo enfoque en el estado del arte en el diseño de lagunas de estabilización," Congreso interamericano de Ingeniería Sanitaria, Lima, Perú, Article for the congress 2005.
- EEA, (2009, March). [Online].  
<http://www.eea.europa.eu/pressroom/newsreleases/drought-and-water-overuse-in-europe>
- EEA, (2012, March). [Online].  
<http://www.eea.europa.eu/pressroom/newsreleases/europe-needs-to-use-water>
- EEA, (2012, November). [Online]  
<http://www.eea.europa.eu/themes/energy/intro>
- EEA, (2013, January). [Online]  
[http://ec.europa.eu/europe2020/europe-2020-in-a-nutshell/targets/index\\_en.htm](http://ec.europa.eu/europe2020/europe-2020-in-a-nutshell/targets/index_en.htm)
- EIA, (2012, December). [Online]  
<http://www.eia.gov/forecasts/aeo/er/>
- Elias X, *Tratamiento y valorización energética de residuos*, First edition ed. Barcelona, Spain: Ediciones Díaz de Santos, 2005.
- EPA, (2003, June). [Online].  
[http://water.epa.gov/aboutow/owm/upload/2004\\_07\\_07\\_septics\\_final\\_sgrit\\_remove.pdf](http://water.epa.gov/aboutow/owm/upload/2004_07_07_septics_final_sgrit_remove.pdf)
- EPA, (2002, October), Office of Water. [Online].  
[http://water.epa.gov/scitech/wastetech/upload/2002\\_10\\_15\\_mtb\\_alagoons.pdf](http://water.epa.gov/scitech/wastetech/upload/2002_10_15_mtb_alagoons.pdf)
- EPIA, "Global Market Outlook for Photovoltaics until 2016", Brussels, Belgium. 2012.
- EPSEL S.A., "Control de calidad periodo 2007.", EPSEL S.A., Chiclayo., Technical report 2007.
- EPSEL S.A., "Manual de limpieza y mantenimiento de las lagunas de oxidación de San José," EPSEL S.A., Chiclayo, Technical report 2008.
- EPSEL S.A., "Control de Calidad al 2010," EPSEL S.A., Chiclayo, Technical report 2010.
- EPSEL S.A., (2010, December) Epsel S.A. [Online]. HYPERLINK  
["http://www.epsel.com.pe/servicios3.php"](http://www.epsel.com.pe/servicios3.php)
- Erazo R and Cardenas J, "Planta de tratamiento de aguas residuales en la Universidad Nacional Mayor de San Marcos, Lima Perú," Revista Peruana de Química e Ingeniería Química - UNMSM (On Line), vol. 3, no. 1, September 2000.
- EWEA, *Global installed wind power capacity, Regional Distribution*, 2010.
- FAOSTAT, Wastewater Database, 2004.
- FAO, (1993, August) fao.org. [Online].  
<http://www.fao.org/docrep/003/t0800s/t0800s09.htm>
- FONAM-Perú. (2008, March) sitio Web Fonam-Perú. [Online].  
<http://www.fonamperu.org/general/energia/renovable.php>
- Font R, Gomez-Rico M, and Fullana A., "Skin effect in the heat and mass transfer model for sewage sludge," Separation and purification technology, no. 77, pp. 146 - 161, 2012
- García-Sayán G, (2006, November) Punto de equilibrio - Universidad de Pacífico. [Online].  
[http://www.puntodeequilibrio.com.pe/punto\\_equilibrio/01i.php?pantalla=noticia&iid=15515&bolnum\\_key=20&serv\\_key=2100](http://www.puntodeequilibrio.com.pe/punto_equilibrio/01i.php?pantalla=noticia&iid=15515&bolnum_key=20&serv_key=2100)
- Gestione Acqua S.P.A, "Adeguamento dell'impianto di depurazione delle acque urbane del comune di Novi Ligure (AL)," Gestione Acqua S.P.A, Milan, Relazione illustrativa 2010.
- Gestione Acqua S.P.A. , "Adeguamento dell'impianto di depurazione delle acque reflue urbane del comune di Novi Ligure (AL)," Gestione Acqua S.P.A., Milán, Relazione tecnica 2010.

- Ginoris Y. Ghesti G. Malafaia F. Brasil A. Macedo J. and Itai Y. *Evaluation of municipal sewage sludge as a biomass resource for the production of energy by gasification*. Proceedings Venice 2010. Third International Symposium on Energy from biomass and Waste. Venice (Italy), 2010.
- Global Development Alliance, "Experiences in Haiti, Ethiopia, and Pakistan: lessons for future water treatment programs", USAID and Safe Drinking Water Alliance, Maryland, USA, 2008.
- Gobierno de Colombia. (2009, October) Ministerio de ambiente, vivienda y desarrollo territorial. [Online].  
[http://www.minambiente.gov.co/documentos/res\\_1959\\_141009.pdf](http://www.minambiente.gov.co/documentos/res_1959_141009.pdf)
- Grosso J, "Simulación de un reactor UASB asumido como un CSTR, utilizando un modelo biocinético completo," University of Bucaramanga, Bucaramanga, Article for congress 2010.
- Hall D, "Biomass energy," Energy policy, vol. 19, no. 8, pp. 711 - 737, October 1991.
- Heffernan B, Van Lier J. B. and Van der Lubbe J, "Performance review of large-scale up-flow anaerobic sludge blanket sewage treatment plants," Water Science & Technology, 2010.
- Lin H, Ma X, "Simulation of co-incineration of sewage sludge with municipal solid waste in a grate furnace incinerator" Waste management. No. 32 pp. 561 - 567. 2012
- IEA. (2011) [Online]  
[http://www.iea.org/stats/regionresults.asp?COUNTRY\\_CODE=21](http://www.iea.org/stats/regionresults.asp?COUNTRY_CODE=21)
- IEA, "Key World Energy Statistic," Paris, France, 2012.
- INEI, "Perfil sociodemográfico del departamento de Lambayeque: Características sociales," Lima, Resultados de los censos nacionales de población y vivienda 2008.
- ISPRA, Utilizzazione dei fanghi di depurazione in agricoltura. [Online].  
<http://www.isprambiente.gov.it/it/temi/suolo-e-territorio/agricoltura/utilizzazione-dei-fanghi-di-depurazione-in-agricoltura>
- Jaeger M, Mayer M., *The Noel conversion process-A gasification process for the pollutant-free disposal of sewage sludge and the recovery of energy and material*. Water Sci. Technol. Vol 50. No. 9 pp. 169 - 175. 2004.
- Jiang R, Li A, and Wang W., "Thin layer drying characteristics and kinetics model of dewatered sludge," Environmental Science, vol. 1, no. 29, pp. 22 - 25, 2009.
- Judex J.W, Gaiffi M, Burgbacher C., *Gasification of dried sewage sludge: Status of the demonstration and the pilot plant*. Waste Management 32. Pp. 719 - 723. 2012.
- Lettinga G and Hulshoff W, *UASB Process design for various types of wastewaters*. Wageningen, Netherlands, 1991.
- Lubello C, "Esercitazione di Dimensionamento di un Impianto di depurazione delle acque reflue," University of Florence, Florence, Academic documentation 2006.
- MEM, "Balance Nacional de Energia 2009," Dirección de eficiencia energética, Lima, Peru, 2010.
- MEM, "Perú sector eléctrico 2009", Dirección general de electricidad, Lima, Perú, Documento promotor 2009.
- Meng D, Jiang Z, Kunio, Y, Mu H, "The effect of operation parameters on the hydrothermal drying treatment", Renewable energy, No. 42 pp. 90 - 94, 2012.
- MENA WATER FZC. (2008) Mena Water. [Online]. [http://www.mena-water.com/downloads/7\\_MBR-package.pdf](http://www.mena-water.com/downloads/7_MBR-package.pdf)
- Mendonça S. (1999) Biblioteca virtual de desarrollo sostenible y salud ambiental. [Online].  
<http://www.bvsde.paho.org/bvsacd/acodal42/operacion.pdf>

- Meneses M, Pasqualino J, and Castells F, "*Environmental assessment of urban wastewater reuse: Treatment alternatives*," *Chemosphere*, July 2010.
- Metcalf & Eddy, *Wastewater engineering: treatment and reuse*, Fourth Edition ed., Casson T, Ed. Crawfordsville, United States: McGraw-Hill, 2003.
- MINAM. Decreto Supremo N° 003-2010-MINAM. *Aprueban Límites máximos permisibles para los efluentes de Plantas de tratamiento de aguas residuales domésticas o Municipales*. Diario El Peruano. Lima (Perú). 2010.
- Ministerio de Economía y Finanzas, "*Ampliación y mejoramiento integral de los sistemas de agua potable y alcantarillado, distrito de San José, Lambayeque, Lambayeque*," Municipalidad distrital de San José, Lima, Proyecto de viabilidad 177659, 2011.
- VIVIENDA, "*Norma OS.090 Plantas de tratamiento de aguas residuales*," Lima, Perú, Decreto legislativo 2009.
- Montalvo S and Guerrero L, *Tratamiento anaerobio de residuos: producción de biogás*, First Edition ed., Universidad Técnica Federico Santa María, Ed. Valparaiso, Chile, 2003.
- Municipalidad distrital de San José. (2011, October) Ubicación geográfica del distrito. [Online].  
 "http://www.munisanjose.gob.pe/index.php?option=com\_content&view=article&id=20&Itemid=13"
- Muttamara S, "*Wastewater characteristics*," *Resources, Conservation and Recycling*, vol. 16, no. 4, pp. 145 - 159, April 1996.
- Nijaguna B, *Biogas technology*. New Delhi, India: New age international, 2002.
- Ngô C and Natowitz J, *Our energy future: resources, alternatives, and the environment*. New Jersey, USA. Wiley. Desurvire E, editor. 2009.
- Osorio F and Torres J, "*Biogas purification from anaerobic digestion in a wastewater treatment plant for biofuel production*," *Renewable energy*, vol. 34, no. 10, pp. 2164 - 2171, October 2009.
- PAHO. (1998, December) *El Fenómeno el Niño 1997 - 1998 en Perú: Capítulo 11*. [Online].  
 "http://www.paho.org/spanish/ped/EINino-cap11-Peru.pdf"
- Parr J, Smith M, and Shaw R. (2005, October) Loughborough University. [Online].  
<http://www.lboro.ac.uk/well/resources/technical-briefs/64-wastewater-treatment-options.pdf>
- Pedrero F, Kalavrouziotis I, Alarcón J, Koukououlakis P, and Asano T, "*Use of treated municipal wastewater in irrigated agriculture – Review of some practices in Spain and Greece*," *Agricultural water management*, vol. 97, no. 9, pp. 1233 - 1241, April 2010.
- Pedroza E, "*Canal Parshall*," Instituto Mexicano de Tecnología del Agua, Mexico, D.F., didactic material, 2001.
- Pescod M, "*Wastewater treatment and use in agriculture*," FAO Irrigation and Drainage Paper, Rome, Italy, 1992.
- RENIEC, "*Perú: población identificada con DNI por grandes grupos de edad y sexo; según grandes lugares de residencia*," RENIEC, Lima, Perú, Estadística 2010.
- Rojas S, López F, Montero I, Miranda, T. Celma A, "*Thin-Layer drying behaviour of sludge of olive oil extraction*," *Journal of Food Engineering*, no. 80, pp. 1267 - 1261, November 2006.
- Rolim S, "*Alcantarillados condominiales: una alternativa para ciudades saludables*," Organización Panamericana de la Salud OPS/WHO, Medellín, Colombia, International congress 1996.



- Rosillo-Calle F, "Biomass energy, forest and global warming," *Energy Policy*, vol. 20, no. 2, pp. 124 - 136, February 1992.
- Royte E, "The last drop," *National Geographic*, vol. 127, no. 4, pp. 172 - 176, April 2010.
- Rulkens W, Bien J., *Recovery of energy from sludge-Comparison of the various options*. *Water Sci. Technol.* No. 50, vol 9, pp 213-221. 2004.
- Rulkens W., *Sewage sludge as a Biomass Resource for the production of energy: Overview and Assessment of the various options*. *Energy & fuel*. No. 1, vol 22, pp. 9-15, 2008.
- Sanbueza J and León G. (1995) Centro Panamericano de Ingeniería Sanitaria - CEPIS. [Online].  
<http://www.cepis.ops-oms.org/bvsacd/scan/029505/029505-09.pdf>
- Schultz T, "Biotreating process wastewater: airing the options," *Chemical engineering magazine*, pp. 44-52, October 2005.
- Schuster G, Löffler G, Weigl K, Hofbauer H., *Biomass steam gasification - an extensive parametric modeling study*. *Bioresource Technology*, 77, pp. 71-79. 2001.
- Seghezzi L, Zeeman G, Van Lier J.B., Hamelers H, Lettinga G, "A review: the anaerobic treatment of sewage in UASB and EGSB reactors," *Bioresources Technology*, no. 65, pp. 175 - 190, 1998.
- Stolarek P, Ledakowicz S. *Thermal processing of sewage sludge by drying, pyrolysis, gasification and combustion*. *Water Sci. Technol.* Vol 42. No.9, pp. 529 - 268. 2001.
- Svanström M, Fröling M, Modell M, Peters W, Tester J., "Environmental assessment of supercritical water oxidation of sewage sludge", *Resource Conservation & Recycling*. No.41 pp. 321-338. 2004.
- Tomasi C, Baratieri M, Bosio B, Arato E, Baggio P., *Process analysis of an MCFC power plant fed with a biomass syngas*. *Power Sources*. vol. 157, p.p. 765 - 774. 2006.
- Tu tiempo network. (2011, July) Tu tiempo.net. [Online]. HYPERLINK  
["http://www.tutiempo.net/clima/Chiclayo/844520.htm"](http://www.tutiempo.net/clima/Chiclayo/844520.htm)
- Turovskiy I, Mathai, P. *Wastewater Sludge Processing*, New Jersey, United States of America: John Wiley & Sons Ltd, 2006.
- UN-United Nations Environment Programme, "Water and wastewater reuse," International Environmental Technology Center, Osaka, Japan, 2005.
- UN-United Nations Environment Program, "Global Environment Outlook 4," Valleta, Malta, ISBN: 978-92-807-2836-1 (UNEP paperback), 2007.
- U.S. Army Corps of Engineers, "HEC-RAS: River Analysis System," Hydrologic Engineering Center, Davis, CA., User's Manual 0720 - 0188 , 2010.
- U.S. Army corps of engineering, "HEC-RAS River analysis system, Hydraulic refers manual," Hydraulic engineering center, Davis, CA, Computer program documentation CPD-69, 2010
- U.S. Environmental protection agency, "Process design manual for sludge treatment and disposal," Center for environmental research information technology transfer, Unites States, Process manual 1979.
- USAID, "Safeguarding the world's water 2008," Report on USAID Water Sector Activities," Washington D.C., USA, 2009.
- Uribe L, "Ampliación y modernización planta de tratamiento de aguas residuales Rio Frio," Empresa Publica de Alcantarillado de Santander, Medellin, Power point presentation 2009.
- Van Haandel A and Lettinga G, *Anaerobic Sewage Treatment: A practical guide for regions with a hot climate*. Chichester, England: John Wiley & Sons Ltd, 1994.

- Vargas G, (2009, March) Viceversa Consulting. [Online].  
[http://www.viceversaconsulting.com/impreso/Cambio\\_Climatico\\_y\\_su\\_impacto\\_en\\_el\\_consumo\\_de\\_Agua\\_Potable\\_en\\_el\\_Peru.pdf](http://www.viceversaconsulting.com/impreso/Cambio_Climatico_y_su_impacto_en_el_consumo_de_Agua_Potable_en_el_Peru.pdf)
- Van Haandel A and Lettinga G, *Anaerobic Sewage Treatment: A practical guide for regions with a hot climate*. Chichester, England: John Wiley & Sons Ltd, 1994.
- Varun, Prakash R and Krishnan I, "Energy, economics and environmental impacts of renewable energy systems," *Renewable and sustainable energy systems*, vol. 13, no. 9, pp. 2716 - 2721, 2009.
- Vaxelaire J, "Moisture sorption Characteristics of waste activated sludge," *Chemical technology and biotechnology*, no. 76, pp. 377 - 382, 2001.
- Von Sperling M, *Biological Wastewater treatment: Waste Stabilization ponds*, First edition ed. New Delhi, India: IWA Publishing, 2007.
- VIVIENDA, "Planes Nacionales de Vivienda y Saneamiento 2006 - 2015," Ministerio de Vivienda, Construcción y Saneamiento - Estado Peruano, Lima, Peru, Plan Nacional 2006.
- Weng C-H, Lin D-F, Chiang P-C, "Utilization of sludge as brick materials", *Advances in Environmental research*. Vol.7, pp. 679 - 685. 2003.
- WHO/UNCEF-JMP, "Estimates for the use of Drinking Water Sources," WHO / UNCEF JMP, Washington D.C., Assessment Reports 2010.

## ANNEXES

### **Annex 1: Wastewater Treatment Processes**

The knowledge about nature of wastewater as well as diverse kind of treatment processes is important for the valuation and design of each step, to reflect about reuse facilities and the management of environmental quality. In this annex is presented a description of wastewater characteristics and treatment processes currently applied in practice and in large-scale plants, since preliminary treatment to tertiary treatment.

#### **1.1. Liquid Waste**

Wastewater is eliminated by humans, after being exploited in different applications: personal hygiene, cooking foods, cleaning, laundry, and so on. FAO<sup>35</sup> defines three types of domestic wastewater: “grey” water which comes from showers and toilets; wastewaters which come from washers and kitchens; and rainwater which comes from rain accumulation. But, sometimes, domestic wastewater can include also uncontrolled sources (illegal dumping) and industrial sewage.

According to FAO, treated wastewater is especially efficient to irrigation, due to the high level of nitrates and sulphates; and for other non-potable applications [FAO, 1993]. Thus drinking water is use only by drinking, cooking, washing, and shower.

Crude wastewater has a different composition according to origin source. The most part of pollutants comes from animal and human excrement, others from water of laundry, kitchens and showers. Rainwater and public water clean, also, have an important pollutions load. Microorganisms as bacteria (Faecal Coliforms, Salmonella, Vibrio Cholerae), parasite (Giardia, Enterobius), protozoa, and so on, are very dangerous for human health and cause enteric diseases (See table 1). They are presents in high concentrations and be transmitted through of vegetables, poor food handling and lack of personal hygiene (See table 2).

Municipal wastewater consist of 99.9% of water and 0.01% of suspended and dissolved organic solids, of these, 70% are organic substances: carbohydrates, proteins, lignin, fats, synthetic detergents, and various natural and synthetic organic chemicals; 30% are inorganic solids as sand, clay, gravel, toxic elements as arsenic, cadmium, chromium, cooper, lead, mercury, zinc and so on [Braatz et al, 1996]. Even if in domestic wastewater toxic materials are not present in concentrations likely to affect humans, they might well be at toxic levels, which would limit their use (Cadmium present in fertilized can be absorbed by crops, and if it is ingested in sufficients quantities causes diarrhea, liver and kidney diseases). The contaminants of greatest concern are the pathogenic micro and macro-organisms.

---

<sup>35</sup> FAO is the acronym for Food and Agriculture Organization from United Nations.

Table 1: Infectious agents potentially present in domestic wastewater.

	<i>Organisms</i>	<i>Disease</i>
Protozoa	<i>Entamoeba histolytica</i>	Amebiasis (amoebic dysentery)
	<i>Giardia lamblia</i>	Giardiasis Ascariasis
Helminths	<i>Áscaris lumbricoides</i>	Enterobiasis Taeniasis
	<i>Enterobius vericularis</i>	
	<i>Taenia saginata</i>	
Bacteria	<i>Shigella</i> (4 spp.)	Shigellosis (Bacillary dysentery)
	<i>Salmonella typhi</i>	Typhoid fever
	<i>Salmonella</i> (1700 spp.)	Salmonellosis
	<i>Vibrio cholerae</i>	Cholera
	<i>Escherichia coli</i> (enteropathogenic)	Gastroenteritis
Viruses	Enteroviruses (67 types)	Gastroenteritis; heart anomalies, meningitis.
	Hepatitis A	Infectious hepatitis
	Adenovirus (31 types)	Respiratory diseases.

Source: [Metcalf &amp; Eddy, 2003].

Table 2: Types and concentrations of microorganisms.

<i>Microorganisms</i>	<i>Concentration (number/ml.)</i>
Coliformes	0.5 - 1.0 x 1000000
<i>Estreptococcus faecales</i>	5 - 20 x 1000
<i>Shigella</i>	Present
<i>Salmonella</i>	4 - 12
<i>Pseudomonas aeruginosa</i>	102
<i>Clostridium perfringens</i>	507
<i>Mycobacterium tuberculosis</i>	Present
Protozoan cysts	100
Helminth eggs	1
Enteric viruses	1 - 492

Source: [Metcalf &amp; Eddy, 2003]

After treatment, wastewater need to be adequate disposed [Da Cámara et al, 2009]. Agricultural irrigation needs a very special attention. Pathogenic viruses, bacteria, protozoa and helminths may be present in raw municipal wastewater in high levels and will survive in the environment for long periods. Pathogenic bacteria will be present in wastewater at much lower levels than the coliform group of bacteria, which are much easier to identify and enumerate (MPN/100ml). *Escherichia coli* are the most widely adopted indicator of faecal pollution and they can also be isolated and identified fairly simply.

### 1.1.1. Characteristics

Wastewater is characterized in terms of its physical, chemical, and biological compositions as principal properties shown in table 3.

Table 3: Physical, chemical and biological characteristics of wastewater and their sources.

<i>Characteristic</i>	<i>Sources</i>
Physical properties:	
Color	Domestic and industrial wastes, natural decay of organic materials
Odor	Decomposing wastewater, industrial wastes
Solids	Domestic water supply, domestic and industrial wastes, soil erosion, inflow/infiltration.
Temperature	Domestic and industrial wastes
Chemical constituents	
Organic:	
Carbohydrates	Domestic, commercial, and industrial wastes.
Fats, oils, and grease	Domestic, commercial, and industrial wastes.
Pesticides	Agricultural wastes.
Phenols	Industrial wastes
Proteins	Domestic, commercial, and industrial wastes.
Priority pollutants	Domestic, commercial, and industrial wastes.
Surfactants	Domestic, commercial, and industrial wastes.
Volatile organic compounds	Domestic, commercial, and industrial wastes.
Other	Natural decay of organic materials.
Inorganic:	
Alkalinity	Domestic wastes, domestic water supply, groundwater infiltration.
Chlorides	Domestic wastes, domestic water supply, groundwater infiltration.
Heavy metals	Industrial wastes
Nitrogen	Domestic and agricultural wastes
pH	Domestic, commercial and industrial wastes.
Phosphorus	Domestic, commercial and industrial wastes; natural runoff
Priority pollutants	Domestic, commercial, and industrial wastes.
Sulfur	Domestic water supply; domestic, commercial, and industrial wastes.
Gases:	
Hydrogen sulfide	Decompositions of domestic wastes.
Methane	Decompositions of domestic wastes.
Oxygen	Domestic water supply, surface-water infiltration.
Biological constituents:	
Animals	Open watercourses and treatment plants
Plants	Open watercourses and treatment plants
Protists:	
Eubacteria	Domestic wastes, surface-water infiltration, treatment plants
Archaeobacteria	Domestic wastes, surface-water infiltration, treatment plants
Viruses	Domestic wastes.

Source: [Metcalf & Eddy, 2003].

Table 4 describes the pollutants of interest in wastewater treatment. Regulations of secondary treatment are based on elimination rates of organic material, suspended solids and pathogens. Often, regulations include refractory organic and heavy metals.

Table 4. Important contaminants of concern in wastewater treatment.

<i>Contaminants</i>	<i>Reasons for importance</i>
Suspended solids	Suspended solids can lead to the development of sludge deposits anaerobic conditions when untreated wastewater is discharged in the aquatic environment.
Biodegradable organics	Composed principally of proteins, carbohydrates, and fats, biodegradable organics are measure most commonly in terms of BOD (biochemical oxygen demand) and COD (chemical oxygen demand). If discharged untreated to the environment, their biological stabilisation can lead to the depletion of natural oxygen resources and to the development of septic conditions.
Pathogens	Communicable diseases can be transmitted by the pathogenic organisms in wastewater and it is not safe by human consume. Pollution of aquatics organism, and comes to human through to food chain.
Nutrients	Both nitrogen and phosphorus, along with carbon, are essential nutrients for growth. When discharged to the aquatic environment, these nutrients can lead to the growth of undesirable aquatic life. When discharged in excessive amounts on land they can also lead to the pollution of groundwater.
Priority pollutants	Organic and inorganic compounds selected on the basis of their known or suspected carcinogenicity, mutagenicity, teratogenicity, or high ascute toxicity.
Refractory organics	These organics tend to resist conventional methods of wastewater treatment. Typical examples include surfactants, phenols and agricultural pesticides.
Heavy metals	Heavy metals are usually added to wastewater from commercial and industrial activities and may have to be removed if the wastewater is to be reused.
Dissolved inorganics	Inorganic constituents such as calcium, sodium, and sulphate are added to the original domestic water supply as a result of water use and may to be removed if the wastewater is to be reused.

Source:[Metcalf & Eddy, 2003 and Muttamara, 1996]

## 1.2. Wastewater treatment processes

Historically, plumping, drainage, drinking water and sewage services are administrated by public companies, department or municipalities. In the most of cases, water supply service and wastewater treatment are deficient. Available financial resources should be always prioritized by water sector, but often this does not happen [Rolim, 1996].

If untreated wastewater is allowed to accumulated, the decomposition of the organic materials can lead to the production of large quantities of malodorous gases, the nutrients can stimulate the growth of aquatic plants, and the toxic compounds can cause soil

pollution. For these reasons, the immediate removal of wastewater from its sources of generation, their treatment and disposal is necessary [Metcalf & Eddy, 2003].

For many years, several methods of treatment have been studied by experts in laboratories and full-scale treatment plants. The interest for an alternative and integrative possibility is always increasing. For each purification plant, the design stage must be preceded by an adequate characteristics definition of wastewater, through their quantity (flow) and quality (contaminants concentration) parameters [Bonomo, 2008]. But, choosing of a technology is a process which considers some factors: the amount and composition of waste, effluent standards regulations, use and disposal options, pre-treatment process, and operational and economic feasibility. Stabilization ponds, for example, are a low-cost alternative but require a large extension of land.

Alternatives of wastewater treatment processes include natural treatment, use of stabilization ponds, land or aquatic treatment systems, and more complex and technological systems. A wastewater treatment processes have mainly following stages:

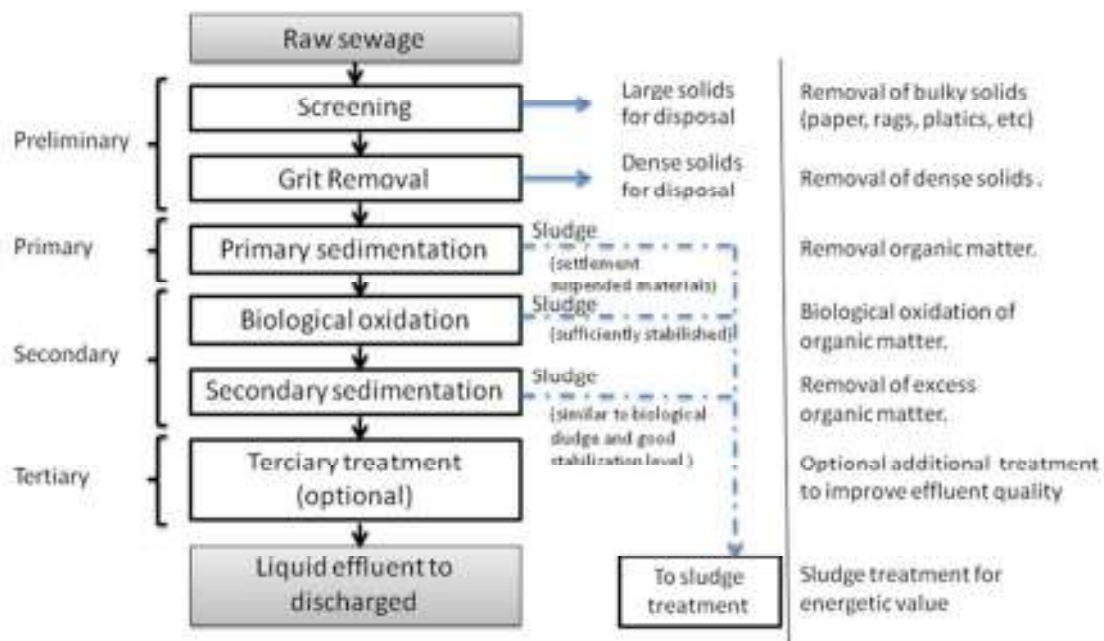

Figure 1. Typical wastewater treatment processes, by-products and uses of sludge.

Preliminary treatment consists of physic methods for removal of large materials; primary treatment, settling by gravity of solid particles; secondary treatment, degradation of biological matter; and tertiary and/or chemical treatment, disinfection. A basic graphical scheme is shown in figure 2.

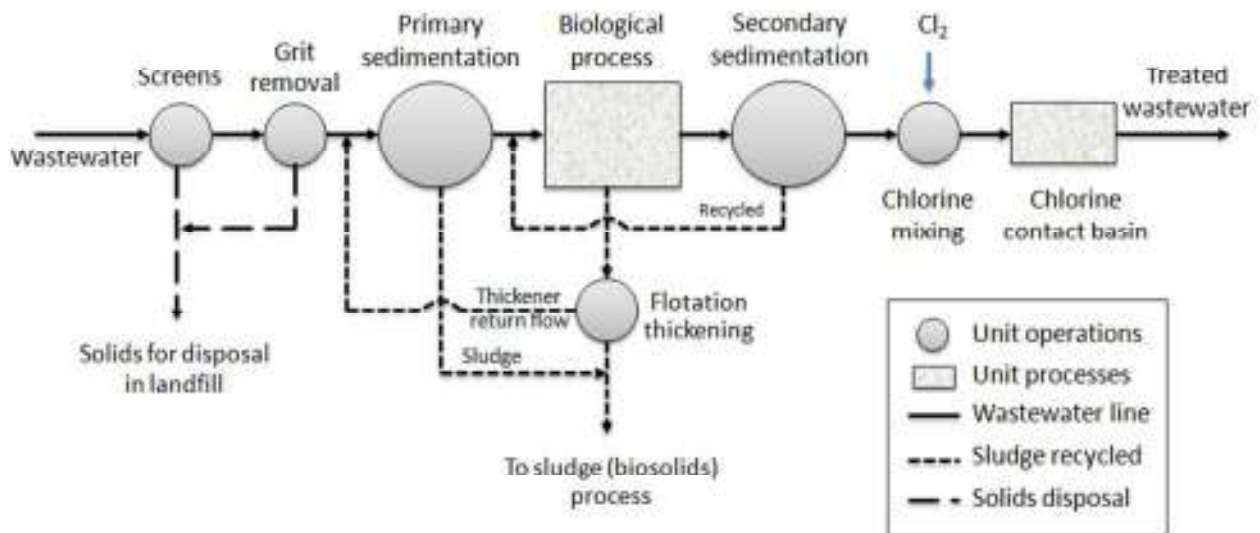

Figure 2: Wastewater treatment plant flow diagram  
Source: [Metcalf & Eddy, 2003].

### 1.2.1. Preliminary treatment

The objective of preliminary treatment is the removal of coarse solids and other large materials present in raw wastewater as well as suspended solids, oil and grease that may cause wear or clogging of equipment and consequently maintenance or operational problems in the successive processes, and ancillary systems; above all, in primary process lines and sludge line [Pescod, 1992]. In addition, a preliminary treatment improves the sludge quality [Bonomo, 2008].

These processes are mechanical nature and it is necessary considered size and characteristics of solid particles. Preliminary operations are screening and grit and oil removal:

- *Screening*: It is a mechanical filtration process. The main goal is protecting and avoiding obstructions in other equipment of subsequent process in order to keep the efficiency of the process. The screening element consists, traditionally, of parallel bars, it also may consist in rods or wires, grating, wire mesh, or perforate plate, and openings may be of any shape but generally are circular or rectangular slots. A screen composed of parallel bars is called bar screen (As shown in Figure 3). It is necessary to know the approximate diameter of solids in order to determine the sizes of bars and space between bars [Bonomo, 2008]. Two types of screens are usually implemented: coarse screens and fine screens. Coarse screens have a space between bars lesser than 0.025mm and fine screens have spaces lesser than 0.010 mm [Metcalf % Eddy, 2003]. Materials are eliminated from screens by automatic hauling, and then they should be disposed in landfill, burning in the plants site, incinerated either alone or in combination with sludge and grit, eliminated together with municipal solids wastes, or discharged to grinders where they are ground.



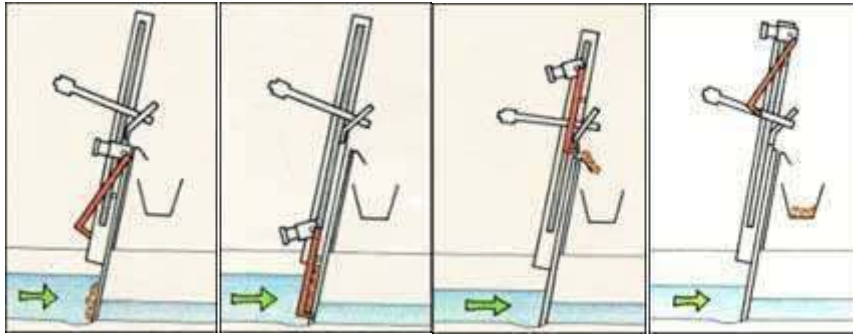

Figure 3: Typical mechanical screening.  
Source: [EPA<sup>36</sup>, 2003].

- *Grit removal*: It includes sand or grit channels or chambers where the velocity of flow is adjusted allowing the settlement of sand, grit, and stones owing to the fact that they and other heavy materials have specific gravities or settling velocities greater than organic solids. For small sanitary sewer systems, grit chambers may not be necessary, but it is desirable at larger plants. The amount of grit removed will vary greatly from one location to another, depending on the type of sewer system, the characteristics of the drainage area, the condition of the sewer, the types of wastes, and the amount of sandy soil in the area. Sieve analyses are not normally performed on grid removal systems. The most common method of disposal is in a landfill or incinerating with sludge.
- *Other Preliminary treatment*: Pre-aeration and flocculation are other preliminary treatment methods. The objectives of aerating wastewater are improving the grease separation, odours control, promoting a uniform distribution of suspended solids and to increasing BOD<sub>5</sub> removals. The purpose of flocculation is to form aggregates or flocs from the finely divided matter. The flocculation is made by mechanical or air agitation and it may be considered when it is desired to increase the removal of suspended solids and BOD<sub>5</sub> in primary settling facilities, especially when the wastewater contains certain industrial wastes.

### 1.2.2. Primary treatment

The objective of primary treatment is the removal of settleable organic and inorganic solids. Approximately 25 - 30% of the incoming Biochemical Oxygen Demand (BOD<sub>5</sub>), 50 - 60% of the total suspended solids and 65% of the oil and grease are removed during primary treatment. Some organic nitrogen, organic phosphorus and heavy metals are also removed. When the sewage will be used to irrigate crops that are not consumed by humans or to irrigate orchards, vineyards and some processed food crops, primary treatment is the minimum level required [Pescod, 1992].

<sup>36</sup> EPA is the acronym for Environmental Protection Agency.

### 1.2.2.1. Sedimentation:

Sedimentation is the separation from water, by gravitational settling, of suspended particles that are heavier than water, while grease and oils rise to the surface and skimmed off. It is one of the most widely used operations in wastewater treatment. Particulated matter, biological floc and chemical flow can be removed. A sedimentation basin may also be referred to as a sedimentation tanks, settling basin or settling tanks.

There are four types that can occur in settling phenomena: discrete particle, flocculant, hindered and compression. During a sedimentation operation, it is common to have more than one type of settling occurring at a given time, and it is possible to have all four occurring simultaneously. Table 5 describes those types.

Primary sedimentation tanks are designed to provide short detention periods and high rates of surface loading; usually ranging from 90 to 180 minutes of detention times for an average rate of flow rate and ahead of biological treatment units. The settlement materials at the bottom of the tank are removed through mechanical collectors.

Table 5: Types of settling phenomena

<i>Type of settling phenomenon</i>	<i>Description</i>
Discrete particle	Refers to the sedimentation of particles in a suspension of low solids concentration.
Flocculants	Refers to a rather dilute suspension of particles that coalesce, or flocculants, during the sedimentation operation.
Hindered (also called zone)	Refers to suspensions of intermediate concentration in which interparticles force are sufficient to hinder the settling of neighbouring particles.
Compression	Refers to settling in which the particles are of such concentrations that a structure is formed, and further settling can occur only by compression of the structure.

Source: [Metcalf & Eddy, 2003].

A critical factor for selection of tank size is the surface-loading rate, generally expressed as volume of wastewater per unit time and unit area of settler ( $\text{m}^3/\text{m}^2 \cdot \text{d}$ ). It depends on the characteristics of the effluent and the solid content which can be determined from the settling tests. The retention time in the settlers is generally in the order of one to three hours, the capacity of the tanks must be determined taking into account the peak flow rates for a good separation. Typical information about the sedimentation tanks design is shown in table 6.

Table 6: Typical information for primary sedimentation tanks designed.

Item	Value	
	Range	Typical
Detention time (Hr)	1.5 - 2.5	2
Surface loading rate ( $\text{m}^3/\text{m}^2 \cdot \text{d}$ )		
Average flow	35 - 48	
Peak hourly flow	80 - 120	100
Weir loading ( $\text{m}^3/\text{m} \cdot \text{d}$ )	125 - 500	250
<i>Dimensions for a rectangular tank</i>		
Depth (m)	3.00 - 4.50	3.6
Length (m)	15.00 - 90.00	25.00 - 30.00
Width (m)	3.00 - 24.00	5.00 - 10.00
Flight speed (m/min)	0.60 - 1.20	1.00
<i>Dimensions for a circular tank</i>		
Depth (m)	3.00 - 4,57	3,66
Diameter (m)	3.60 - 6.00	12.00 - 45.00
Bottom slope (mm/m)	60.00 - 165.00	80.00
Flight travel speed (r/min)	0.02 - 0.05	0.03

Source: [Metcalf & Eddy, 2003].

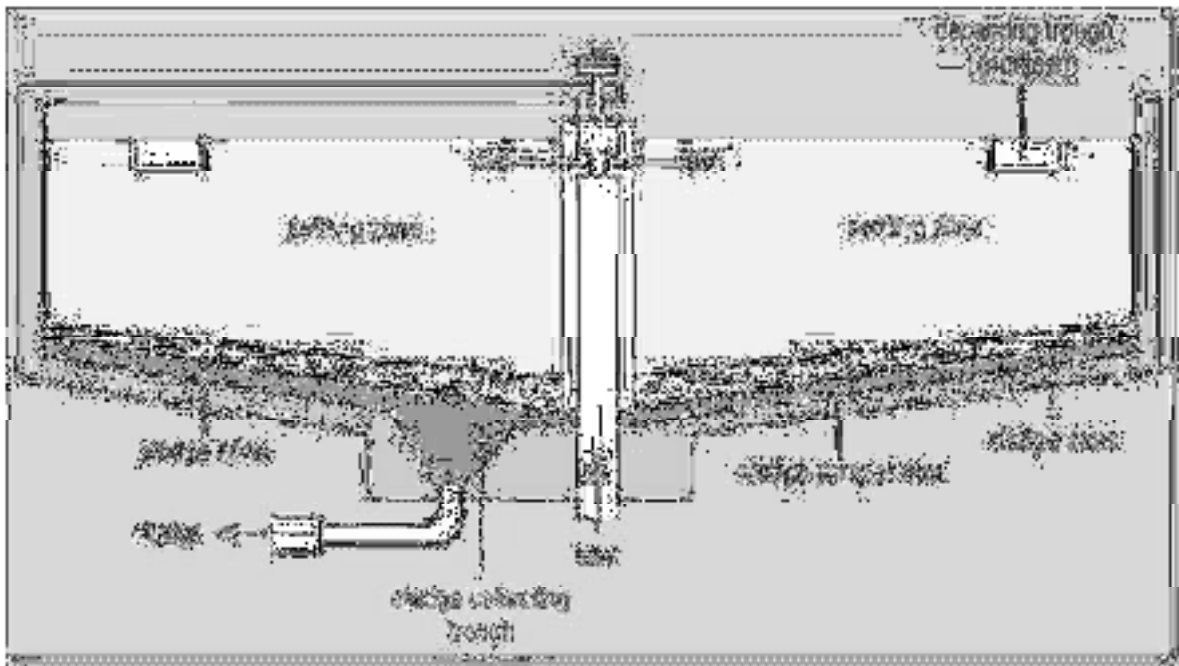

Figure 4: Typical circular sedimentation tanks

Source: [Parr et al, 2005].

Circular tanks are the most frequently used. The effluent circulates radially and the wastewater can be introduced in the centre or around the periphery of the tank, the solids are generally removed near the centre. In the centre feed design, wastewater is carried to the centre of the tank in a pipe suspended from the bridge or encased in concrete beneath the tank floor. At the centre of the tank, the wastewater enters a circular well designed to distribute the flow equally in all directions. In the peripheral-feed design, a suspended

circular baffle a short distance from the tank wall forms an annular space into which the wastewater is discharged in a tangential direction. The wastewater flows spirally around the tank and underneath the baffle, and the clarifier liquid is skimmed off over weirs on both sides of a centrally located weir trough. A scheme of circular tank was shown in figure 4.

#### **1.2.2.2. Anaerobic ponds.**

Ponds are basins designed to receive, hold, and treat wastewater for long periods of time. An anaerobic lagoon is a deep earthen basin impoundment, essentially free of dissolved oxygen that promotes anaerobic conditions. Wastewater is treated naturally through a combination of physical, biological, and chemical processes. Anaerobic ponds are not aerated, heated, or mixed; and they are the simplest reactors that exist; biogas is released into the atmosphere because they are not covered.

The main goal of anaerobic ponds is reducing the settleable organic load with big HRT from 5 to 30 days and until 150 days; and surface organic load from 100 - 500 kgBOD<sub>5</sub>/ha.day or more [Montalvo et al, 2003]. They must be individually designed to fit an specific site and use. Designs are based on such factors as type of soil, amount of land area available, and climate. Anaerobic ponds are only appropriated in areas with warm winters, because the activity of the microorganisms is highly dependent on temperature, anaerobic bacteria is ineffective below 15°. Surface load and additional depth depends of average water temperature during the coldest month of the year.

Dimensions are critical, a large surface area and adequate depth of 2.0 m not exceeding 6.0 m is necessary for anaerobic conditions and sludge accumulation. The sludge removal should be realized when the sludge bed reach half the effective height, which should not occur in less than 5 years. Problems about inefficiencies and inadequate mixing contact between the wastewater and the anaerobic biomass can occur [EPA, 2002].

Due to its big dimensions, high HRT, and low organic loads, anaerobic ponds can be considered as anaerobic reactors of low volumetric load. An important design consideration for ponds includes the amount and type of wastewater to be treated and the level of treatment required by regulations. Effluents from anaerobic are not suitable for discharge to the environment; they must be followed by aerobic or facultative ponds to provide required treatment. They are usually preceded for a bar screen and Parshall flume. Applying semi-empirical rules and developed in the practice have a good results [EPA, 2003].

Wastewater enters near the bottom and mixes with the active microbial mass in the sludge blanket where anaerobic conditions prevail. In the surface layer the excess undigested grease and scum are concentrated and aerobic conditions prevail. Sometimes aeration is provided at the surface to control odors.

The action of anaerobic bacteria in the absence of dissolved oxygen converted organic materials into stable products such as biogas. The biogas produced by anaerobic lagoons is

50 to 75% methane, with carbon dioxide making up most of the rest. The degradation process involves two separated but interrelated phases: acid formation and methane production. During the acid phase, bacteria convert complex organic compounds (carbohydrates, fats, and proteins) into simple organic compounds (acetic, propionic, and lactic acids). During this phase, reduction of COD or BOD<sub>5</sub> is produced. After that, bacteria convert those simple organic compounds into acetate, hydrogen gas, and carbon dioxide. This process is the acetogenesis. Subsequently, several species of strictly anaerobic bacteria (methanogenic microorganisms) called “methane formers” convert the acetate, hydrogen, and carbon dioxide into methane gas (CH<sub>4</sub>) through one of two major pathways [Metcalf % Eddy, 2003]:

1) The breakdown of acetic acid to form methane and carbon dioxide:

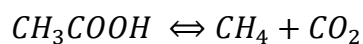

2) The reduction of carbon dioxide by hydrogen gas to form methane (methanogenesis):

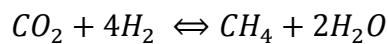

During methanogenesis, waste stabilization occurs, represented by the formation of methane gas. Figure 5 explains degradation process in an anaerobic pond.

The possibility of recovering biogas produced in the biodegradation process is in studying in order to reduce the environmental impacts caused by greenhouses emissions but the cover of anaerobic ponds can be too expensive, in fact, this is not a a common practice.

Anaerobic lagoons are not applicable to many situations because of large land requirements, sensitivity to environmental conditions, and objectionable odors. But it is a financially attractive alternative due to its low construction and operating costs, minimal power requirements, although sludge must occasionally be removed [Mendonça, 1999 and Sanbueza et al, 1995].

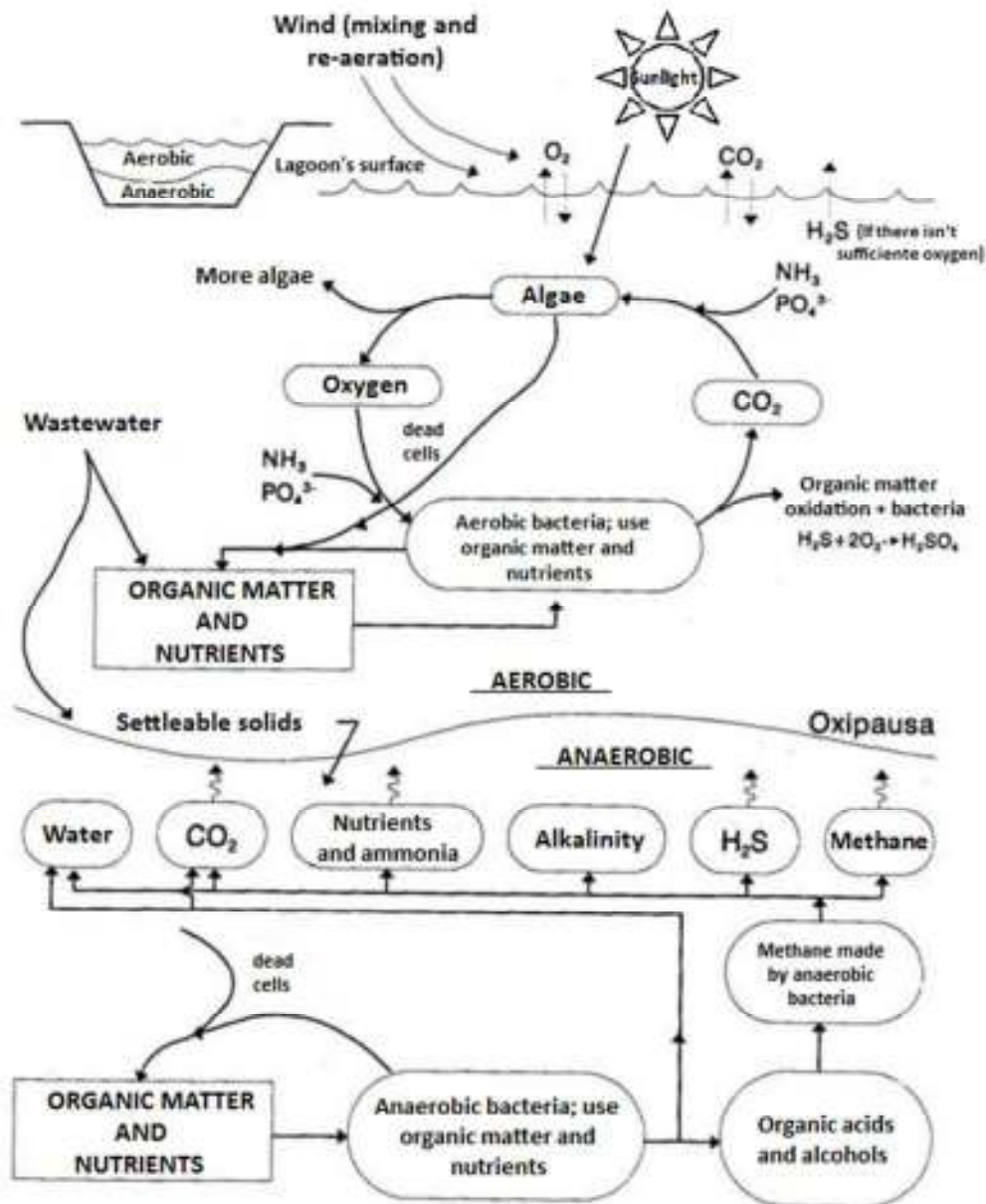

Figure 5. Biological degradation scheme of anaerobic ponds.

### 1.2.3. Secondary treatment

Secondary treatment or Biological treatment is designed substantially for degradation of biological content of the sewage and stabilization of organic matter (BOD<sub>5</sub>) through microbial populations. Bacteria and protozoa consume biodegradable soluble organic contaminants and much of the less soluble fractions into floc, various gases and cell tissue.

Most of the microorganisms present in wastewater treatment systems use the organic content as an energy source to grow, but they also can use oxygen. Regarding the use of oxygen, they can be classified in aerobic, anaerobic and facultative (can proliferate either in absence or presence of oxygen although using different metabolic processes). Biological treatment processes are broadly classified as aerobic processes (aerobic and facultative microorganisms predominate) or anaerobic. Aerobic processes involve the use of free or

dissolved oxygen by microorganism (aerobes) in the conversion of organic wastes to biomass and CO<sub>2</sub>.

Anaerobic systems have several advantages such as can be operated under high solids retention times and very low hydraulic retention times and a great application to the treatment of low strength wastewater, represents a simple and low-cost technology with advantages regarding operation and maintenance. A comparison between aerobic and anaerobic processes is presented in table 7.

Table 7: Comparison between aerobic and anaerobic treatment processes.

<i>Feature</i>	<i>Aerobic</i>	<i>Anaerobic</i>
Organic removal efficiency	High	High
Effluent quality	Excellent	Moderate to poor
Residence time	Low	High
Organic Loading rate	Moderate	High
Sludge production	High	Low
Nutrient requirement	High	Low
Alkalinity requirement	Low	High for industrial waste
Energy requirement	High	Low to moderate
Temperature sensitivity	Low	High
Start-up time	2 - 4 weeks	2 - 4 months
Proliferation of odour	Low	Potential odour problems
Bioenergy and nutrient recovery	No	Yes
Technical requirements	Low	High
Land requirements	High	Low
Economic requirements	High	Low

Source: [Chan et al, 2009].

Anaerobic treatments present a high methane production with high calorific value, and very low solids productions. As seeing in the figure 6, in the aerobic reactors, only 40 to 50% of organic matter is converted into CO<sub>2</sub>, from 50 to 60% is incorporated as microbial biomass, and the excess about 5 to 10% leaves the reactor as non-degraded material. While in anaerobic systems, a great part of the organic material is converted into biogas, which is of about 70 to 90%; from 5 to 15% only is converted into microbial biomass which constituted the excess sludge of the system, and non-degraded material

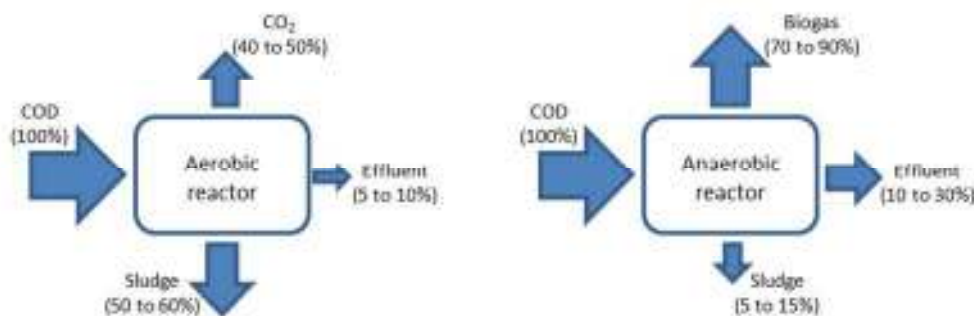

Figure 6. Biological conversion in aerobic and anaerobic systems.

Source: [De Lemos, 2007]

In anaerobic processes, complex organic wastes are degraded into CH<sub>4</sub>, CO<sub>2</sub> and H<sub>2</sub>O through four basic steps: Hydrolysis, Acidogenesis, Acetogenesis and Methanogenesis. Hydrolysis and acidogenesis is where enzymes excreted by fermentative bacteria convert complex, heavy, un-dissolved materials (proteins, carbohydrates, fats) into less complex, lighter, materials (amino acids, sugars, alcohols); as the flow rises through the granulated sludge the Hydrolysis reaction is consumed and converted into an Acetogenesis form; Acetogenesis is where digestion products are converted into acetate, H<sub>2</sub>, CO<sub>2</sub> and new cell-matter; as the rise continues the Acetogenesis is consumed and enters the Methanogenesis phase. In methanogenesis phase the hydrogen plus carbonate, formate or methanol were converted into CH<sub>4</sub>, CO<sub>2</sub> and new cell-matter, in the absence of oxygen [Da Cámara et al, 2009 and Chan et al, 2009].

Aerobic processes are suitable for the treatment of low strength wastewater (biodegradable COD concentrations less than 1,000 mg/l) while anaerobic systems are suitable for the treatment of high strength wastewater (biodegradable COD concentration over 4,000 mg/l) [Chan et al, 2009]. The majority of domestic wastewater treatments plants treat the sewage using aerobic biological processes. But, the anaerobic biological processes are, also, used by urban wastewater and the experiences show high levels of efficiency. Both systems are capable of achieving high organic removal efficiency.

Anaerobic treatment requires less energy with potential bioenergy and nutrient recovery. However, compared to anaerobic systems, aerobic systems achieve higher removal of soluble biodegradable organic matter material and the produced biomass is generally well flocculated, resulting in lower effluent suspended solids concentration. As a result, the effluent quality from an aerobic system is generally higher than the anaerobic treatment.

Advantages of anaerobic treatment permit a rapid development in the treatment of both industrial and municipal wastewater. Combined anaerobic-aerobic processes are operationally and economically feasible.

One of the keys of an effective biological treatment is controlling the environment required for optimum growth of the microorganism involved and quantity of maximum flows and the organic loads to be treated [Schultz, 2005].

Biological treatment is a promising technology to attain revenue from CER<sup>37</sup> credits, more commonly known as Carbon credits from CDM<sup>38</sup> due to methane gas generated from anaerobic digestion represents a renewable energy source [Chan et al, 2009].

---

<sup>37</sup> CER is the acronym for Certified Emissions Reductions

<sup>38</sup> CDM is the acronym for Clean Development Mechanisms.



### 1.2.3.1. Anaerobic processes.

The anaerobic reactor of interest in this research is the “Up-flow anaerobic sludge blanket (UASB)”.

#### *Up-flow anaerobic sludge blanket (UASB) reactor.*

Up-flow anaerobic sludge bed (UASB) reactor is a robust technology and has performed well in wastewater treatment for a number of decades. They are extensively exploited as a treatment before aerobic treatment for various types of industrial and municipal wastewater since 1970 [Chamy, 2003].

In a UASB reactor, the wastewater enters near the bottom of the reactor and has an up-flow through a dense sludge blanket with high microbial activity which consists of dense granules biologically formed (with diameter of 1 - 4mm) due to the nature self-immobilization of the anaerobic bacteria [Erazo et al, 2000]. This is an essential condition for the successful operation of UASB reactors.

The contaminants are degrading biologically at the moment to enter in contact with biomass generating large quantities of biogas ( $\text{CH}_4$ ,  $\text{CO}_2$  and others). The COD reduction causes expansion/fluidization of sludge blanket. When the biogas is released from the granules, the sludge falls back at the bottom of the reactor, and biogas is collected by chamber at the top of the reactor, designed by this objective, wastewater leave the reactor at the top by overflowing [Da Cámara et al, 2009].

The generation of biogas causes internal circulation which helps in the formation and maintenance of the granules, removing sludge bed and permits the interchange of these with wastewater. The granular form and high density of sludge avoids that microorganisms are removed by the up-flow water. The liquid contains some residual solids and biological granules; it passes into a settling chamber where the residual solids are separated from the liquid. The separated solids fall back through the baffle system to the top of the sludge blanket. To keep the sludge blanket in suspension, up-flow velocities must be in the range of 0.6 to 0.9 m/h.

Figure 6 shows a scheme of UASB reactor.

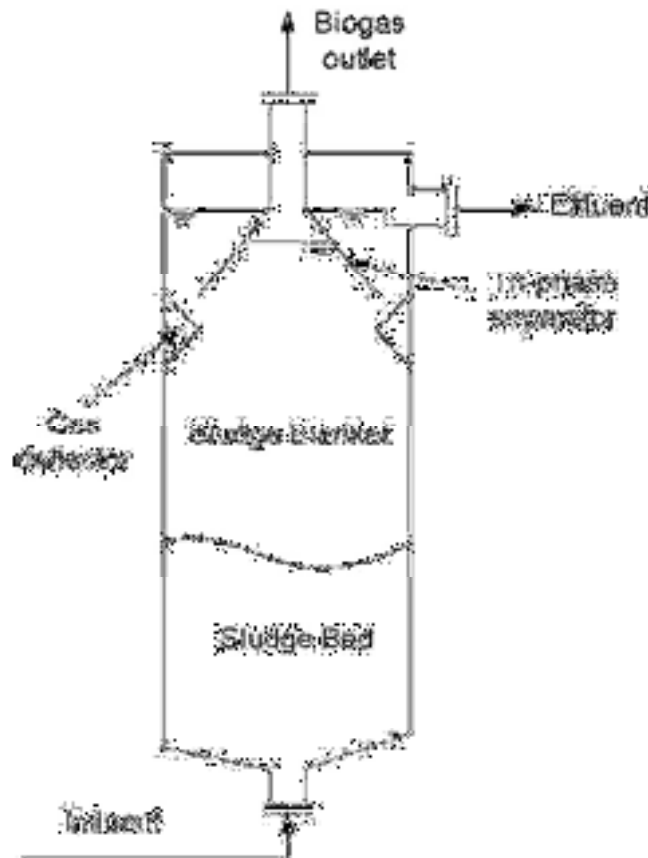

Figure 6: Schematic representation of an UASB reactor  
Source: [Montalvo et al, 2003].

The key points for designer of UASB reactor are the effluent distribution system and three-phase separator GLS (Gas-liquid-solid). The first one is designed to distribute wastewater homogeneously; an inadequate distribution causes dead zones in the digester reducing its efficiency. Three-phases system has several chamber separated by baffles, where gas is collected, this system determined the retention time of the sludge into the reactor [Chamy, 2003].

A UASB reactor requires a long time for start-up about 3 months. During start-up process, the hydraulic loading must be 50% of the design hydraulic loading. The start-up of the UASB reactor can be considered complete once a satisfactory performance of the system has been reached at its design load.

### 1.2.3.2. Aerobic processes.

Aerobic reactors of interest in this research are “Activated-sludge process” and “Aerobic membrane bioreactor (MBR)”.

### *Activated sludge process.*

Activated sludge, consists a stirred and aerated flocculated suspension of a mixed bacterial population that comes into contact with wastewater, is the most commonly used process in aerobic treatment. It has high efficiency with operational flexibility and possibility for nutrient removal. However operating activated sludge system alone requires a high level of mechanization, high construction and the need for treating a substantial amount of sludge.

Operationally, organic wastes are introduced into a reactor where aerobic bacteria are maintained in suspension. The reactor content is a "mixed liquor". Wastewaters are mixed vigorously by aeration device which also supply oxygen to the biological suspension. The aeration device most common used includes submerged diffusers that release compressed air and mechanical surface aerators that introduced air by agitating at the liquid surface. The hydraulic retention time in the aeration tanks usually ranges from 3 to 8 hours but can be higher with high BOD<sub>5</sub> wastewater. Following the aeration step, the microorganisms are separated from the liquid by sedimentation and the clarified liquid is secondary effluent. A portion of the biological sludge is recycled to the aeration basin to maintain a high level of suspended solids in the "mixed liquor". The remainder is removed from the process and sent to sludge processing to maintain a relatively constant concentration of microorganisms in the system [Pescod, 1992]. The level of biological mass in the reactor should be kept according to the desired treatment efficiency and other considerations related to growth kinetics. The bacterial culture carries out the conversion according to the following reactions [Metcalf & Eddy, 2003]:

Scheme of oxidation and synthesis:

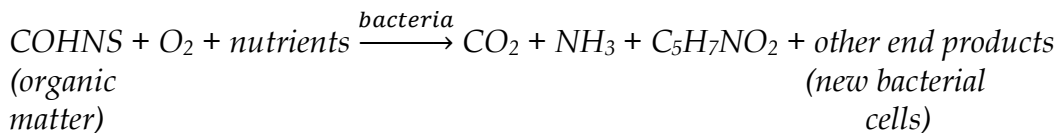

Scheme of endogenous respiration:

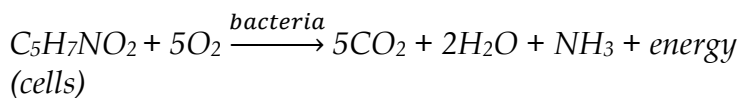

Stable organic end products are also formed.

In this process the bacteria are the most important microorganisms because they are responsible for the decomposition of the organic material in the influent. In the reactor or aeration tank, a portion of the organic waste is used by aerobic and facultative bacteria obtaining energy for the synthesis of the remainder of the organic material. Only a portion of the original waste is actually oxidized to low-energy compounds such as NO<sub>3</sub>, SO<sub>4</sub> and CO<sub>2</sub>; the remainder is synthesized into cellular material, also, many intermediate products are formed before the end products. The formation of floc is also important, because is a requisite for the effective separation of the biological solids in the settling unit.

For a design of activated sludge process is possible assume these points: The contents of the reactor are mixed completely; an integral part of the activated sludge process is the sedimentation tank in which the cells from the reactor are settled and then returned to the reactor; waste stabilization by the microorganism occurs only in the reactor unit; and, the volume calculated for an average residence time for the system includes only the volume of the reactor unit.

A particular system consists of a UASB reactor for anaerobic pretreatment, followed by activated sludge for aerobic post treatment. A significant feature of this system is the return of the excess aerobic sludge to the UASB reactor where the solids undergo stabilization, and thus the sludge treatment is simpler. The overall sludge production of the anaerobic - aerobic system is coming only from the UASB reactor. Since it is already thickened and stabilized, it can be directly sent for dewatering and final disposal. This system can typically remove 83 - 98% of COD with influent content in the range of 500-20,000 mg/l and with a total HRT of 11.54 hours to 6 days.

The anaerobic-aerobic system manifests steady operation performance, while the activated sludge treatment system without anaerobic pretreatment produces effluent with oscillatory quality. The anaerobic-aerobic process reduced greatly electrical consumption in the plant, and then operational costs are lowers.

### ***Aerobic membrane bioreactor (MBR)***

The combination of activated sludge biodegradation and membrane separation is known as membrane bioreactor process (MBR). MBR process utilizes the Activated Sludge Process, but replace conventional final settlement with an ultrafine membrane. It is generally regarded as one alternative to the conventional Activated Sludge Process.

In a MBR, solid materials, biomass, pathogenic bacteria, and even macromolecules are retained while allowing water and smaller solution species pass through the membrane, so that a very high quality effluent is obtained. This process is ideally suited in a wide range of municipal and industrial wastewater treatment applications including water reuse, new housing developments, parks and resorts.

MBRs offer numerous advantages, it is used for high-strength wastewater, sludge retention time can be controlled independently from Hydraulic retention time, sludge production is low, the removal of bacteria and viruses can be achieved without adding any chemical, and, COD removal of 99% in the treatment of wastewater with COD content in the range of 6,000 - 14,500 mg/l with relative short HRT. The main disadvantage is the high cost by installation and operation and the limited experiences in use of membrane for wastewater treatment.

The two major types of membrane used in wastewater treatment are: Microfiltration, with pores size from 0.1 to 0.4  $\mu\text{m}$ ; and ultrafiltration, with pores size from 2 - 50 nm. There are two configurations of MBR systems based on the location of membrane

modules: submerged membrane bioreactor system; and, externally pressured cross flow MBR. In submerged membrane bioreactor system, the membrane is directly immersed in an aeration tank, because permeate is extracted by suction or, less commonly, by pressurizing the bioreactor. This process can also be easily used to retrofit the conventional activated sludge process without significant modifications to the existing plant.

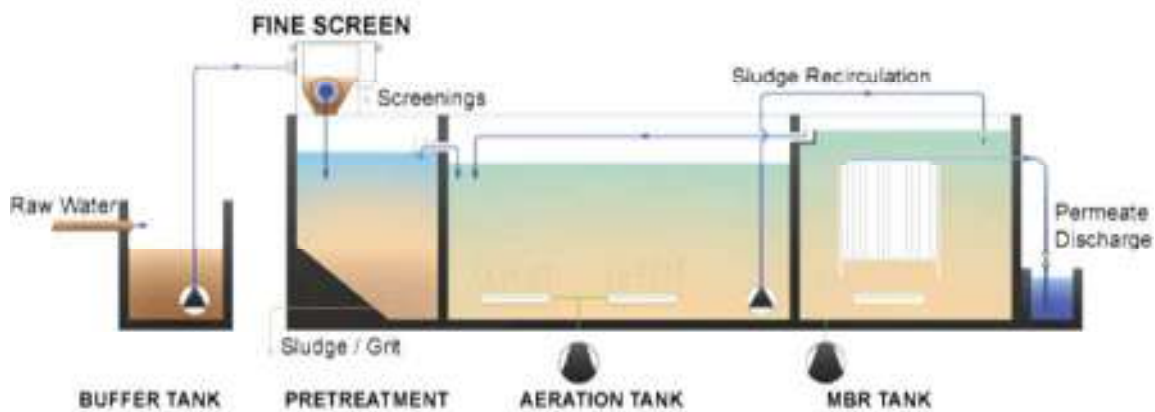

Figure 7: Schematic diagram of submerged membrane bioreactor system  
Source: [Mena water, 2008].

### 1.2.3.3. Simultaneous systems.

#### *UASB reactor and stabilisation ponds.*

An alternative to treat wastewater combined anaerobic and aerobic technologies is applying stabilisation ponds as post-treatment for effluents from anaerobic reactors, such as UASB reactors [Von Sperling, 2007]. It is mainly used for the removal of pathogenic organism due to the low retention times in the anaerobic reactor. Pathogenic removal occurs principally in the aerobic ponds. Ponds are also called polishing ponds in this kind of treatment. Additional BOD<sub>5</sub> and nutrients can be removal in aerated ponds and the detention times can be reduced.

As well as, UASB reactors reach a good level of efficiency considering low retention times, the simplicity of the process and the non-existence of other equipment; stabilisation ponds maintain the conceptual simplicity in the system. This system is most commonly applied in warm-climate and developing countries. Many experiences in South America (Colombia and Brazil) have shown high-rates of efficiency, the final effluent is directly discharged into the environment for irrigation of crops or other applications.

The system is born as an adaptation of already existing treatment plants with anaerobic – facultative ponds. A significant advantage of this system is the saving in land requirements, but it should be understood that the UASB reactor is not simply replacing the anaerobic ponds, but also the facultative ponds. Details of this system are extending in Chapter 3.

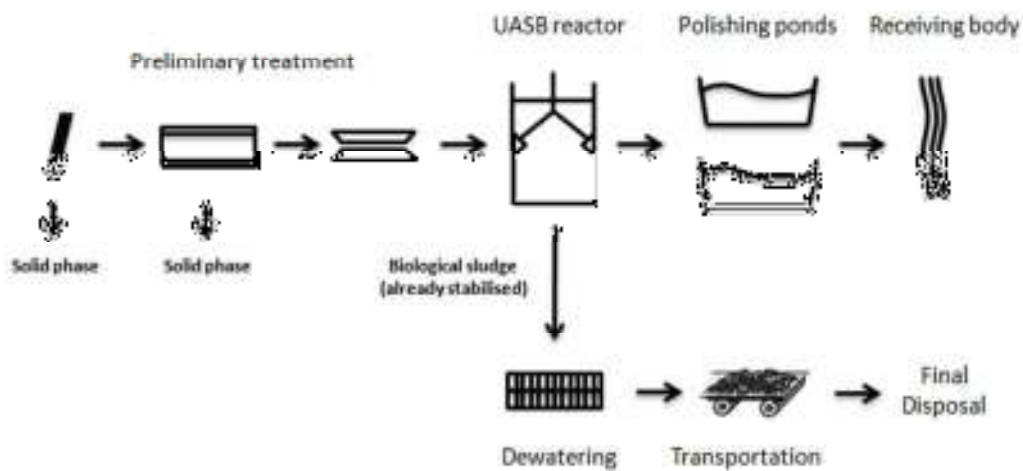

Figure 8: Schemany diagram of UASB reactors followed by polishing ponds.  
Source: [Von Sperling, 2007]

#### 1.2.4. Tertiary treatment

Tertiary individual treatment processes are necessary to remove nitrogen, phosphorus, additional suspended solids, refractory organics, heavy metals and dissolved solids. Advanced treatment usually follows high-rate secondary treatment. Sometimes, advanced treatment processes can be combined with primary or secondary treatment adding chemical to primary sedimentation or aeration basins to remove phosphorus. The most common process used is disinfection and when disinfection is practiced, it is always the final process.

- *Disinfection:* The purpose is to substantially reduce the number of microorganisms in the water to be discharged back into the environment. The effectiveness of disinfection depends on the quality of the water being treated, the type of disinfection being used, the disinfectant dosage (concentration and time), and other environmental variables [Metcalf & Eddy, 2003]. Common methods of disinfection include ozone, chlorine, ultraviolet light or sodium hypochlorine. Disinfection by chlorine involves the injection of a chlorine solution in a chlorine contact basin. The chlorine dosage depends on the strength of the wastewater, dosage of 5 to 15 mg/l are common [Pescod, 1992]. Chlorine contact basins are usually rectangular channels with baffles designed to provide a contact time of about 30 minutes. However, to meet advanced wastewater treatment requirements, a chlorine contact time of as long as 120 minutes is required. One disadvantage of disinfection with chlorine is that chlorination of residual organic material can generate chlorine-organic compounds that may be carcinogenic or harmful to the environment. Then, effluent must also be treated chemically dechlorinated, adding to the complexity and cost of treatment.

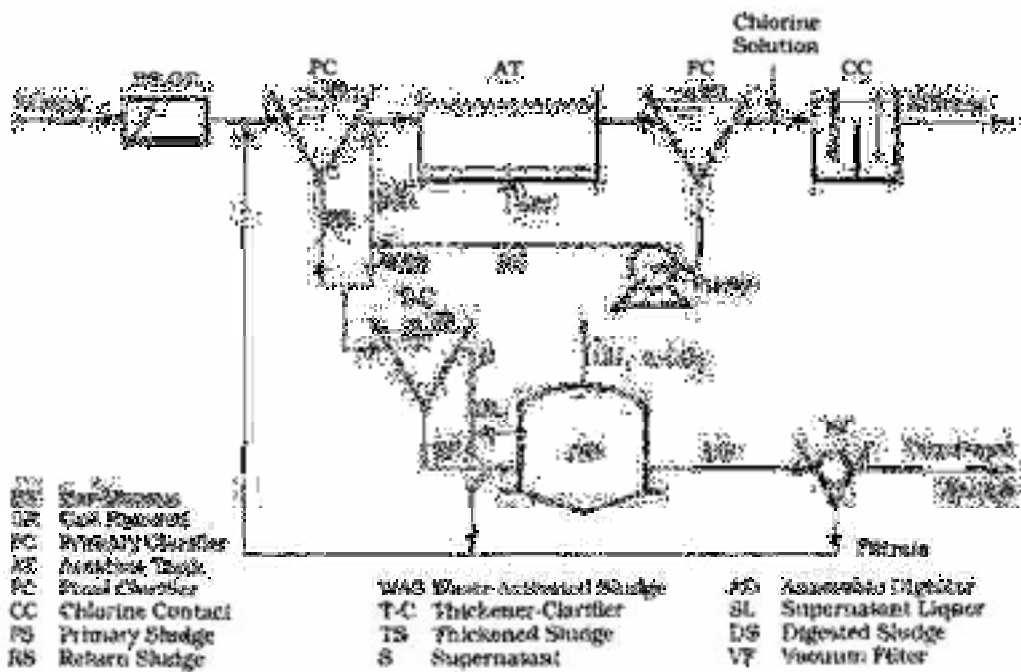

Figure 9: Activated sludge plant and anaerobic digester for a municipal wastewater

## Annex 2: Environmental Impact Assessment (EIA) of the Proposal

The proposal studied in this work, as well as, any kind of proposed project, needs an study of environmental impact assessment in order to provide the possible positive or negative impact, including also social and economic aspects. This annex present a preliminary study of EIA regarding the project of large-scale UASB wastewater treatment plant under the concepts of Peruvian framework.

### 2.1. Legal framework

In Peru, the SEIA<sup>39</sup> from MINAM<sup>40</sup> analyses the potential impacts of any project implementing laws and policies according to the technical, productive and environmental criteria. In this sense, the Environmental Impact Assessment is not only a legal process; it is also a management instrument.

SEIA was created by Law N°27446 on 20<sup>th</sup> April, 2001. It is a unique and coordinate system for the identification, prevention, supervision and control of negative environmental impacts of the ongoing project. The SEIA is responsible of check and validate the Environmental Assessment Studies, where, the following paragraphs must be detailed: Description of proposed actions and the influence area; identification and characterization of potential environment impacts during the project cycle; environmental management strategies; citizen plan participation; monitoring, security and control plan; and, executive summary of easily understood. Moreover, regional authorities correspondent to regional projects are designed by SEIA.

Peruvian government is making important progress about environmental protection, especially since the United Nations Conference on Environment and Development, Rio de Janeiro 1992.

Regarding the wastewater treatment processes and plant planning, mainly, there are two regulations one of them about wastewater treatment plants and the other one about the treatment processes.

- a) *D.S. N°022-2009-VIVIENDA*. It is a technical norm “S090 for Wastewater treatment plants”. All technical dispositions for WWTP design and building are expressed. Regulations for feasible studies and basic engineering are detailed; each step and each kind of treatment are described, and rules for final disposal and discharge according to final effluent and wastes characteristics are given.
- b) *D.S. N°003-2010-MINAM*. It is law decree, published on 17th March, 2010. This decree establishes the “Maximum permissible limits for effluent from domestic wastewater treatment plants”. The goal is the control of concentration levels on physics, chemical and biological substances present in the effluent in order to avoid risks to human

---

<sup>39</sup> SEIA is the Spanish acronym for Sistema Nacional de Evaluación de Impacto Ambiental.

<sup>40</sup> MINAM is the Spanish acronym for Ministerio del Ambiente.



health and environmental degradation. The rule establishes deadlines for the progress adaptation of WWTP to the new limits. New monitoring regulations are established. In no more than two years, all WWTPs must have an environmental certification (San José WWTP does not have an environmental certification). Many treatment plants around the country are continuously monitoring, including San José. The maximum permissible limits disposed by this law decree are reported in the table 8:

Table 8: Maximum permissible limits for effluents for domestic WWTP.

<i>Parameter</i>	<i>Unit measure</i>	<i>Maximum limit</i>
Oil and fats	mg/l	20
Fecal Coliforms	MPN/100ml	10 <sup>5</sup>
Chemical oxygen demand	mg/l	100
Biological oxygen demand	mg/l	200
pH	Unit	6.5 – 8.5
Total suspended solids	mg/l	150
Temperature	°C	< 35

Source: [MINAM. 2010]

## 2.2. Environmental situation and variables.

At the moment, Lambayeque Region does not present an optimal environmental situation. Part of the pollution derives in fact from the sewage discharges. A short description of the main environmental variable to taken account is presented in this paragraph.

- Water: Drinking water sources, rivers, groundwater and any other water source are considered in this variable. San José rural community is employing for their farms the wastewater treated from de San José WWTP through an open channel constructed by the farmers. Some water analyses are making by EPSEL S.A. according to method determined in the laws but the parameters found are not ranging into the limits permissible.
- Air: San José district is characterized by sea breeze, with winds on the direction from South to North (parallel to the beach), average velocities are 12.0 km/h during the mornings and 19.0 km/h during the evenings. Unfortunately, the air is polluted with gases and odors from WWTP [Municipalidad distrital de San José, 2011].
- Weather: The weather is desertic (sub-tropical and arid climate); scarcity precipitations during all seasons of the year (77 mm annual average); and moderate temperatures about 20°C during the year with high atmospheric humidity. Weather conditions can be modified during the ENSO (El Niño–Southern Oscillation) phenomenon presence causing variable flows in the rivers, increasing the temperature in the atmosphere and consequently variations on biological resources in the sea and the rivers, modifying the winds directions and marine currents [PAHO, 1979].
- Soil: The soil is flat and sandy; it is a typical soil from coastal plains with sandy and arid dunes. The soil can be affected (erosion, permeability and productivity) by

wastewaters leakage in the subsoil and inadequate management of irrigation water, causing appearance of vegetation roots in the surfaces, variations of fauna and flora species and changing color soil.

- Fauna and flora: Seabirds are the typical fauna in San José district; furthermore, domestic animals as pets and poultry are considered too. Coastal desert vegetables are the typical flora.
- Landscape: The landscape consists of a coastal desert, ocean, and vegetables covered dunes. The nearest population is 1.0 km far away.
- Social, economic and cultural framework: There are other little communities in the neighboring areas of the treatment plant (San José - chief towns-, Chornanca, El Mirador, Gallito, Pampa de Perros, Ciudad de Dios, El Carrilo, Grauz, Laguna Verde, San Andrés). San José is located 12.9 km from Chiclayo city and 4.0 a.m.s.l, at the southwest of the province of Lambayeque. The unique access road is Chiclayo-San José route, where daily there is a high traffic of public light transportation (minibuses and pickups) and trucks transporting hydrobiology products and wood for shipyards.

There is a rural health clinic; infant, primary and medium school; a rural market, a cemetery, fishing terminal, and police station. The illiteracy rate is 5.4% and the malnutrition rate is 34% [INEI, 2008]. There is a high rate of gastrointestinal and dermic diseases, due principally to the unsafe water consumption, inadequate excrete disposal, untreated wastewater use, inadequate hygienic habits and several communities do not have a good coverage of potable and drainage services. Consequently the diseases rate is decreasing from 87% in 2006 to 79% in 2010 with reducing of population life quality [Ministero de Economía y Finanzas, 2011].

The socio-cultural level is low. The main economic activities are: fishing, agriculture and shipyards. Most housing are built with noble material (90%), 96% of housing are private. The average monthly household income is about 403.0 Peruvian nuevo sol (approx. 100.8 euros). Electrical services is during the whole day in San José chief town, while in the other communities is only few hours a day. 77% of total population has electrical services, 11% gets energy from benzene, 4.67% gets artificial light from candles, 1% gets energy from gasoil, 0.05% uses a generator, 1.31% does not have any type of energy and 5% from other sources [INEI, 2008]. About 25% of population do not have services of drinking water, drainage and electricity.

FONCODES<sup>41</sup> qualifies San José and the communities as “no extreme poverty level” and PNUD<sup>42</sup> qualifies as “low poverty level”

- Wastes: Solid wastes are disposed in open areas out of the Reque city. This is a source of insect, bacteria and very bad odours. Sometimes, those communities does not have

---

<sup>41</sup> FONCODES is the Spanish acronym for Fondo Nacional de Cooperación y Desarrollo.

<sup>42</sup> PNUD is the Spanish acronym for Programa de las Naciones Unidas para el desarrollo

a drainage system and their sewage are disposed in the sea without any kind of treatment.

### 2.3. Environmental impacts generate with current treatment process.

Following environmental impacts have been identify with the current wastewater treatment process.

Table 9: Identification of environmental impacts from the current wastewater treatment.

<i>Environmental variable</i>	<i>Impact</i>
Biologic	Habitats and species alterations. Threat of marine life and local fauna. Inadequate effluents for agricultural lands irrigation.
Water	Seawater pollution. Groundwater pollution.
Air, atmosphere and weather	Greenhouse gases emissions. Increasing of seawater and atmosphere temperature. Bad odours.
Soil and landscape	Wastewater leaks in underground. Landscape damage.
Social	Pulmonary and dermal diseases. Allergies due to the odours and polluting substances in the atmosphere. Disturbances in the human activities.
Economic	It is not a source of new jobs. No investments for new projects. Population does not have basic services.
Culture	No development programs. No contingents plans in cases of natural disasters or flow rates increases. Weak environmental commitment Weak environmental culture Energy deficit. No control about laws compliance.

### 2.4. Potential impacts and mitigation measure.

The aims of this proposal are mainly mitigating the negative impacts on the environment due to discharge and disposal of domestic sewage and studying the residual biomass as source of energy generation. Consequently, improving the life quality of the communities and giving opportunities for a sustainable development.

Impacts can be classified as direct or indirect. Direct impacts include decreasing risks for public health, gastrointestinal and dermal diseases, and decreasing of environmental pollution, improving final effluents quality and water bodies receivers.

Indirect impacts include increasing of fishing incomes, touristic and recreational activities, lower chemical fertilizers requirement and increasing agricultural and forest productivity. Lower other water sources demand. Moreover, saving about medical services.

The potential environmental impacts are reassumed in the following table.

Table 10: Identification of potential impacts for the proposal of a new wastewater treatment plant.

<i>Environmental variable</i>	<i>Impact</i>
Biologic	Biological fertilizers Improving of agricultural land, soils and products.
Water	Improving of treated effluents quality. Improving of seawater quality in the discharges areas. Possibile terziari treatment.
Air, atmosphere and weather.	Decreasing oh greenhouse gases emissions. Decreasing of affected areas by bad odours.
Soil and landscape	Drilling and earthmoving.
Social, economic and culture	Increasing of scientific and educational interest. Decreasing of diseases rates. Creates new jobs sources. Stimulates of environmental awareness. Contingents plans development. Clean energy generation. Energy royalties for Lambayeque Region. Obtaining Carbon credits e environmental certifications.

At the same time, impacts are related to each phase of the project development.

Table 11: Identification of potential impacts during construction and course phases.

<i>Project phase</i>	<i>Impact</i>
Construction phase	Dusting, noise and truck traffic increase. Possible groundwater pollution due to drilling. There are not expected public or private wells for drinking water in order avoid interferences with underground aquifer. Irregular operation of the plant during period of interconnection between new works and currents works. The plant would not be shut down more than one working day.
Course phase	Possible toxic and non-biodegradable substance discharges decreasing the treatment plant efficiency specially the biological treatment and subsequent sludge treatment. The toxic substances can cause poisoning of bacterial biomass

with bulking phenomenon, consequently bad sedimentation of solids and then they can be discharges together with the effluent.

During screening, the block of the moving parts of the screens can causes a malfunction of the biological system and dumping sludge, accumulation of solids wastes and bad odours.

Biologic risks during wastewater discharge and dumping sludge.

Leaks and fire hazard in the biogas treatment.

Falling risks and industrial accidents, but which must be completely avoided.

Mitigation measures must be present during all phases of the projects. Citizen participation, health education and prevention programs must be taken account too.

Table 12: Mitigation measures.

<i>Impact</i>	<i>Measures</i>
Noise and bad odours.	<p>Installation of aspiration and deodorization system in the sludge storage areas.</p> <p>Installation of covered system.</p> <p>Construction of landfill for solid wastes from preliminary treatment.</p> <p>Implementation of a noise control system.</p> <p>Machines and equipment with high levels of noise must be limited to use in daytimes and with a specific municipal permit.</p>
Conservation of fauna and flora.	<p>Minimizing the area of the plant.</p> <p>Avoiding leaving excess material in dunes.</p> <p>Determining specific areas for excess material disposal.</p> <p>Landfill constructions.</p>
Soil and landscape	<p>Not waterproof any area not required for the project.</p> <p>Building materials must be prepared in previously places determined for that goal.</p> <p>Earthmoving and drilling must be done avoiding effect the near structures and utility network.</p> <p>The inert materials product from excavations can be used in the works if these will adjust to the specifications</p> <p>The excess inert materials must be managed holistically trying to be able to use in works in the surroundings or in authorized areas.</p>
In cases when plant is shut down	<p>Anticipating situations to put out some equipment or process stages due to the inconvenience such as maintenance, faulty or machine or their components broken.</p> <p>Anticipating alternatives equipment or machines and lines of treatment.</p>

Hazards	<p>The plant needs a first aid kit implementation and making appropriate preventive prophylaxis (tetanus, typhoid, Hepatitis and so on vaccination).</p> <p>Rules such as no smoking, not use open flames, electric, gasoil and benzene engines, and tools that result in fire or explosion.</p> <p>Mandatory use of personal protective equipment.</p> <p>Including rules and behavior in case of emergency.</p> <p>Taking attention on the locations of the areas for toilets and first aid.</p> <p>Taking attention on the location of the areas for machine deposit and toolrooms.</p>
Citizen participation	<p>Implementing training programs of environmental awareness involving the communities and the primary and medium schools.</p>

Positive impact demonstrate the improving of environmental categories involved, the effluent quality and the consequences on the water bodies receivers and on the agricultural lands, and regarding social issue the offer employment increasing related to each phase of the project.

It is important to mentioned that the wastewater treatment plant registers the lowest rate of industrial accidents, over the world, very serious accidents have never been verified (fires, explosions) that may affect the surrounding populations.

## 2.5. Economic considerations.

One of the advantages of UASB reactors over the conventional systems for sewage treatment is mainly the low initial investment and maintenance costs, a rapid amortization of cost with attractive economic balance, especially when gas and biosolids applications are considered.

A not detailed economic research was done for this work, but it is possible to make an approximate economic evaluation. It indicates that the initial investment is about 7,500,000 USD, which comprises all costs for a UASB industrial plant: machinery, equipment, transport units, furniture, constructions, fixed charges and administrative expenses. In addition, a working capital for the firsts six months is necessary. Working capital considers the necessary resources for the starting production and commercialization and this is about 333,000.00 USD with an annual rate increase of 20%.

Operating costs are classified as fixed charges, variable charges and administrative costs. Fixed charges are salaries, direct materials, depreciation, insurances and so on. Variable charges depends on the production level, corresponds at 10% of sales. And administrative costs are relates with administrative activities, administrative salaries, taxes, basic services, fuel, and so on. The operating cost for the first year has reached about 500,000.00 USD with an annual rate increase of 6%.

Incomes are represented by energy sales, sludge drying sales, and Carbon credit. Regarding energy sales, OSINERG<sup>43</sup> taxes are applied (0.35 USD/kw.h generated from Residual biomass) are applied. Many ONGs in Lambayeque can buy dried sludge for compost at 1.5 USD /kg. And regarding Carbon credits, 1 ton CH<sub>4</sub> is equivalent to 21 ton CO<sub>2</sub> reduced, and the price can vary from 10 USD to 20 USD for each 1 ton CO<sub>2</sub> reduced.

Financing sources can be Ministry of energy, Ministry of Environment, National Found for the Environment, Inter-American Development Bank, World Bank or Intermediate Technology Development Group. National ministries motivate the energy generation projects for rural areas and integrating to the National grid, as well as, the sustainable use of energy sources. Inter-American Development Bank finances economic-social and institutional development projects in Latin American and the Caribbean. The World Bank is financing public and private electricity generation projects for rural areas in Peru. And, the Intermediate Technology Development Group is financing hydro-power central station in Peru. According to the initial investment and capital work, about 8,000,000 USD loan is necessary, that can be paid in 10 years with an annual interest rate of 0.16%.

This project can be economic feasible, and a Cash flow developed with a projection for 15 years can demonstrated it. NPV (Net present value) is about 10,000,000 USD and IRR (Internal rate of return) is 18.1%. The capital can be recovered in 13 years, but with significant generate funds since the 6<sup>th</sup> year.

---

<sup>43</sup> OSINERG is the Spanish acronym for Organismo Superior de la Inversion en Energia y Minería.

Table 4.30. Projected cash flow.

<b>CASH FLOW</b>																
<i>Variables in the time</i>	<i>Year 0</i>	<i>1st year</i>	<i>2nd year</i>	<i>3th year</i>	<i>4th year</i>	<i>5th year</i>	<i>6th year</i>	<i>7th year</i>	<i>8th year</i>	<i>9th year</i>	<i>10th year</i>	<i>11th year</i>	<i>12th year</i>	<i>13th year</i>	<i>14th year</i>	<i>15th year</i>
Energy production (kw.h)		3,628,800.00	4,354,560.00	5,225,472.00	6,270,566.40	7,524,679.68	9,029,615.62	10,835,538.74	13,002,646.49	15,603,175.78	18,723,810.94	22,468,573.13	26,962,287.76	32,354,745.31	38,825,694.37	46,590,833.24
Total working capital		123,355.12	148,026.14	177,631.37	213,157.65	255,789.18	306,947.01	368,336.41	442,003.70	530,404.44	636,485.32	763,782.39	916,538.87	1,099,846.64	1,319,815.97	1,583,779.16
Incremental working capital			24,671	29,605	35,526	42,632	51,158	61,389	73,667	88,401	106,081	127,297	152,756	183,308	219,969	263,963
Depreciation		384,525.32	384,525.32	384,525.32	384,525.32	384,525.32	384,525.32	384,525.32	384,525.32	384,525.32	384,525.32	384,525.32	384,525.32	384,525.32	384,525.32	384,525.32
<b>Capital flow</b>	<b>Year 0</b>	<b>1st year</b>	<b>2nd year</b>	<b>3th year</b>	<b>4th year</b>	<b>5th year</b>	<b>6th year</b>	<b>7th year</b>	<b>8th year</b>	<b>9th year</b>	<b>10th year</b>	<b>11th year</b>	<b>12th year</b>	<b>13th year</b>	<b>14th year</b>	<b>15th year</b>
Investment on fixed assets	9,016,378															
Working capital	-123,355	-24,671	-29,605	-35,526	-42,632	-51,158	-61,389	-73,667	-88,401	-106,081	-127,297	-152,756	-183,308	-219,969	-263,963	-316,756
Recovery of working capital																
Rescue value of the fixed asset																
Tax on sale of fixed asset																
<b>Capital cash flow</b>	<b>8,893,022.88</b>	<b>-24,671.02</b>	<b>-29,605.23</b>	<b>-35,526.27</b>	<b>-42,631.53</b>	<b>-51,157.84</b>	<b>-61,389.40</b>	<b>-73,667.28</b>	<b>-88,400.74</b>	<b>-106,080.89</b>	<b>-127,297.06</b>	<b>-152,756.48</b>	<b>-183,307.77</b>	<b>-219,969.33</b>	<b>-263,963.19</b>	<b>-316,755.83</b>
<b>Operational flow</b>	<b>Year 0</b>	<b>1st year</b>	<b>2nd year</b>	<b>3th year</b>	<b>4th year</b>	<b>5th year</b>	<b>6th year</b>	<b>7th year</b>	<b>8th year</b>	<b>9th year</b>	<b>10th year</b>	<b>11th year</b>	<b>12th year</b>	<b>13th year</b>	<b>14th year</b>	<b>15th year</b>
Incomes		1,604,697.21	1,925,636.65	2,310,763.98	2,772,916.78	3,327,500.13	3,993,000.16	4,791,600.19	5,749,920.23	6,899,904.28	8,279,885.14	9,935,862.16	11,923,034.59	14,307,641.51	17,169,169.82	20,603,003.78
Expenditure																
* Fixed charge		598,836.25	634,766.43	672,852.41	713,223.56	756,016.97	801,377.99	849,460.67	900,428.31	954,454.00	1,011,721.24	1,072,424.52	1,136,769.99	1,204,976.19	1,277,274.76	1,353,911.25
Administrative expenses		113,411.59	120,216.29	127,429.27	135,075.02	143,179.52	151,770.30	160,876.51	170,529.10	180,760.85	191,606.50	203,102.89	215,289.07	228,206.41	241,898.79	256,412.72
Variable charge		127,453.50	152,944.20	183,533.04	220,239.65	264,287.58	317,145.09	380,574.11	456,688.93	548,026.72	657,632.07	789,158.48	946,990.17	1,136,388.21	1,363,665.85	1,636,399.02
* Depreciation		384,525.32	384,525.32	384,525.32	384,525.32	384,525.32	384,525.32	384,525.32	384,525.32	384,525.32	384,525.32	384,525.32	384,525.32	384,525.32	384,525.32	384,525.32
Total expenditure		1,224,227	1,292,452	1,368,340	1,453,064	1,548,009	1,654,819	1,775,437	1,912,172	2,067,767	2,245,485	2,449,211	2,683,575	2,954,096	3,267,365	3,631,248
Profit before taxes		380,471	633,184	942,424	1,319,853	1,779,491	2,338,181	3,016,164	3,837,749	4,832,137	6,034,400	7,486,651	9,239,460	11,353,545	13,901,805	16,971,755
Taxes		114,141	189,955	282,727	395,956	533,847	701,454	904,849	1,151,325	1,449,641	1,810,320	2,245,995	2,771,838	3,406,064	4,170,542	5,091,527
Net profit		266,329	443,229	659,697	923,897	1,245,644	1,636,727	2,111,315	2,686,424	3,382,496	4,224,080	5,240,656	6,467,622	7,947,482	9,731,264	11,880,229
(+) Depreciation		384,525	384,525	384,525	384,525	384,525	384,525	384,525	384,525	384,525	384,525	384,525	384,525	384,525	384,525	384,525
<b>Generated funds</b>		<b>650,855</b>	<b>827,754</b>	<b>1,044,222</b>	<b>1,308,423</b>	<b>1,630,169</b>	<b>2,021,252</b>	<b>2,495,840</b>	<b>3,070,949</b>	<b>3,767,021</b>	<b>4,608,605</b>	<b>5,625,181</b>	<b>6,852,147</b>	<b>8,332,007</b>	<b>10,115,789</b>	<b>12,264,754</b>
<b>Total cash flow</b>	<b>Year 0</b>	<b>1st year</b>	<b>2nd year</b>	<b>3th year</b>	<b>4th year</b>	<b>5th year</b>	<b>6th year</b>	<b>7th year</b>	<b>8th year</b>	<b>9th year</b>	<b>10th year</b>	<b>11th year</b>	<b>12th year</b>	<b>13th year</b>	<b>14th year</b>	<b>15th year</b>
Capital	8,893,023	-24,671	-29,605	-35,526	-42,632	-51,158	-61,389	-73,667	-88,401	-106,081	-127,297	-152,756	-183,308	-219,969	-263,963	-316,756
Operative	0	650,855	827,754	1,044,222	1,308,423	1,630,169	2,021,252	2,495,840	3,070,949	3,767,021	4,608,605	5,625,181	6,852,147	8,332,007	10,115,789	12,264,754
Debt repayment				848,927	848,927	848,927	848,927	848,927	848,927	848,927	848,927	848,927	848,927	848,927	848,927	848,927
<b>Economic Cash Flow</b>	<b>-8,893,023</b>	<b>626,184</b>	<b>798,149</b>	<b>159,769</b>	<b>416,864</b>	<b>730,084</b>	<b>1,110,936</b>	<b>1,573,246</b>	<b>2,133,622</b>	<b>2,812,014</b>	<b>3,632,382</b>	<b>4,623,498</b>	<b>5,819,913</b>	<b>8,112,038</b>	<b>9,851,826</b>	<b>11,947,998</b>
NPV	14,082,438															
IRR	18.14%															



## **Annex 3: MathCAD Procedure**

### Annex 3: MathCAD Procedure

**Mass Balance for a Control Volume inside the system: Drying sewage sludge with diffusion of water through the layer of sludge**

$$M_{in} - M_{out} + M_{gen} = M_{accu} \quad M_{gen} = 0$$

With the following definitions:

- $M_{in}$  = Mass flow in
- $M_{out}$  = Mass flow out
- $M_{gen}$  = Mass generated (by reaction)
- $M_{accu}$  = Mass accumulated in the control volume

Since our mass flow in and out can be related to the flux, we can write the following:

$$(N_A \cdot A_c)_{in} - (N_A \cdot A_c)_{out} = \frac{dM}{dt} = \frac{d(C_A \cdot \Delta V)}{dt}$$

\* $A_c$  = cross sectional area

With constant area and volume, we get the following:

$$A_c \cdot [(N_A)_{in} - (N_A)_{out}] = \Delta V \cdot \frac{dC_A}{dt}$$

For a rectangular control volume, we have the following relationship:

$$A_c \cdot \Delta x = \Delta V$$

Plugging this in:

$$\frac{[(N_A)_{in} - (N_A)_{out}]}{\Delta x} = \frac{[(N_A)_{out} - (N_A)_{in}]}{\Delta x} = \frac{dC_A}{dt}$$

Taking the limit as  $\Delta x$  approaches zero:

$$\lim_{\Delta x \rightarrow 0} \frac{[(N_A)_{out} - (N_A)_{in}]}{\Delta x} = \frac{-dN_A}{dx}$$

If we use Fick's Law, we see that:

$$N_A = -D_{AB} \cdot \frac{dC_A}{dx}$$

Plugging this into the relation above:

$$\frac{-dN_A}{dx} = \frac{-d}{dx} \left( -D_{AB} \frac{dC_A}{dx} \right) = \frac{dC_A}{dt}$$

With constant diffusivity, we have:

$$D_{AB} \frac{d^2 C_A}{dx^2} = \frac{dC_A}{dt}$$

For our system, we have the following boundary conditions:

$t = 0$        $\frac{C_A}{C_S + C_A} = 0.85$        $C_A = \frac{C_S}{0.15}$       This is equivalent to the mass fraction, assuming a volume of unity. Since the mass fraction is the water weight divided by the total weight (sludge and water), we get this expression.

$x = 0$        $\frac{dC_A}{dx} = 0$       Like you said, symmetry about the central axis.

$x = L$        $-D_{AB} \frac{dC_A}{dx} = k_c (C_{Av} - C_{A\infty})$       This is the convective boundary condition. It states that the flow of water coming in to the external "shell" volume element is equal to the water leaving due to convection. Since convection is only occurring in the vapour phase, we may also use partial pressures. For completeness, I have only used concentrations.

One thing that I would like to add here is something I had not yet considered. The case that we were dealing with before had a constant flux out. This generally is not the case, and it leads to a time-independent solution. To combat this, we'll introduce an equilibrium constant relating the concentration at the surface to the concentration just outside the surface (in the vapour phase). This will be defined as:

$$K = \frac{C_{Av}}{C_{As}}$$

This will make our third boundary condition:

$x = L$        $-D_{AB} \frac{dC_A}{dx} = k_c (C_{As} \cdot K - C_{A\infty})$       where       $C_{As} = C_A(x = L)$

Performing some algebra, we get:

$$-D_{AB} \frac{dC_A}{dx} = k_c \cdot K \cdot \left( C_{As} - \frac{C_{A\infty}}{K} \right) = k_c \cdot K \cdot (C_{As} - C_{A\infty K}) \quad \text{where} \quad C_{A\infty K} = \frac{C_{A\infty}}{K}$$

Now, we will perform a transformation of variables, similar to how you did for the problem. Rather than using the moisture content  $X_{A,w}$ , we will use the concentration of water in the air divided by  $K$ .

$$\chi = \frac{C_A - C_{A\infty K}}{C_{A0} - C_{A\infty K}} \quad \tau = \frac{t \cdot D_{AB}}{L^2} \quad \xi = \frac{x}{L}$$

Solving for our dependent variables (so we can resubstitute them back in):

$$C_A = \chi \cdot (C_{A0} - C_{A\infty K}) + C_{A\infty K} \quad \implies \quad dC_A = d\chi \cdot (C_{A0} - C_{A\infty K})$$

$$x = \xi \cdot L \quad \implies \quad dx = L \cdot d\xi$$

$$t = \frac{\tau \cdot L^2}{D_{AB}} \quad \implies \quad dt = d\tau \cdot \frac{L^2}{D_{AB}}$$

If we use the dimensionless variables, we get the following expression:

$$\frac{d^2 \chi}{d\xi^2} = \frac{d\chi}{d\tau}$$

With these boundary conditions:

$$\tau = 0 \quad \chi = \frac{C_S}{0.15} - C_{A\infty K}$$

$$\xi = 0 \quad \frac{d\chi}{d\xi} = 0$$

$$\xi = 1 \quad \frac{d\chi}{d\xi} = \frac{-k_c \cdot L \cdot K}{D_{AB}} \cdot \frac{(C_A - C_{A\infty K})}{(C_{A0} - C_{A\infty K})} = -f \cdot \chi$$

Now we proceed to use the separation of variables method to solve this partial differential equation:

$$\chi = E(\xi) \cdot F(\tau)$$

Which gives us the following:

$$F \cdot \frac{\delta^2 E}{\delta \xi^2} = E \cdot \frac{\delta F}{\delta \tau}$$

This leads to two separate functions of one variable - separating these we get:

$$\frac{1}{E} \cdot \frac{\delta^2 E}{\delta \xi^2} = \frac{1}{F} \cdot \frac{\delta F}{\delta \tau} = -\lambda^2$$

Separating the two functions, we now have:

$$\frac{d^2 E}{d\xi^2} + \lambda^2 E = 0 \quad \text{and} \quad \frac{dF}{F} = -\lambda^2 \cdot d\tau$$

Assuming a solution for E(ξ) and solving F(τ) analytically:

$$E = a_1 \cdot \sin(\lambda \cdot \xi) + a_2 \cdot \cos(\lambda \cdot \xi) \quad \text{and} \quad F = b_1 \cdot e^{-\lambda^2 \tau}$$

Since we defined χ above, we can now substitute these back into that original equation:

$$\chi = E(\xi) \cdot F(\tau) = (a_1 \cdot \sin(\lambda \cdot \xi) + a_2 \cdot \cos(\lambda \cdot \xi)) \cdot (b_1 \cdot e^{-\lambda^2 \tau})$$

Distributing the b<sub>1</sub> integration constant, we are now left with two new constants, c<sub>1</sub> and c<sub>2</sub>:

$$\chi = (c_1 \cdot \sin(\lambda \cdot \xi) + c_2 \cdot \cos(\lambda \cdot \xi)) \cdot (e^{-\lambda^2 \tau})$$

Using our three boundary conditions, we can now solve for the three constants, c<sub>1</sub>, c<sub>2</sub>, and λ:

For the first boundary condition:

$$\xi = 0 \quad \frac{dX}{d\xi} = 0$$

$$\frac{dX}{d\xi} = (c_1 \cdot \lambda \cdot \cos(\lambda \cdot \xi) - c_2 \cdot \lambda \cdot \sin(\lambda \cdot \xi)) \cdot (e^{-\lambda^2 \tau})$$

at  $\xi=0$ :

$$\frac{dX(\xi=0)}{d\xi} = (c_1 \cdot \lambda - 0) \cdot e^{-\lambda^2 \cdot \tau} = 0 \quad \implies \quad c_1 \cdot \lambda = 0 \quad \implies \quad c_1 = 0$$

we now have for  $X$ :

$$X = (c_2 \cdot \cos(\lambda \cdot \xi)) \cdot (e^{-\lambda^2 \tau})$$

For the second boundary conditions:

$$\xi = 1 \quad \frac{dX}{d\xi} = -f \cdot X$$

$$\frac{dX(\xi=1)}{d\xi} = -c_2 \cdot \lambda \cdot \sin(\lambda) \cdot (e^{-\lambda^2 \tau}) = -f \cdot (c_2 \cdot \cos(\lambda)) \cdot (e^{-\lambda^2 \tau})$$

Simplifying this expression:

$$c_2 \cdot (\lambda \cdot \sin(\lambda) - f \cdot \cos(\lambda)) = 0 \quad \implies \quad \lambda \cdot \tan(\lambda) = f$$

Since the tangent function is infinitely repeating, we must include all of the values for  $\lambda$  which satisfy this constraint. We now have for our expression of  $X$ :

$$X = \sum_n \left( c_{2n} \cdot \cos(\lambda_n \cdot \xi) \cdot e^{-\lambda_n^2 \cdot \tau} \right)$$

For the third boundary condition:

$$\tau = 0 \quad \chi = \frac{\frac{C_S}{0.15} - C_{A\infty K}}{C_{A0} - C_{A\infty K}} = \frac{C_{A0} - C_{A\infty K}}{C_{A0} - C_{A\infty K}} = 1$$

$$\sum_n (c_{2n} \cdot \cos(\lambda_n \cdot \xi)) = 1$$

The solution to this can be found according to Plawsky:

$$c_{2n} = \frac{4 \cdot \sin(\lambda_n)}{2 \cdot \lambda_n + \sin(2 \cdot \lambda_n)}$$

Which give us for  $\chi$ :

$$\chi = \sum_n \left( \frac{4 \cdot \sin(\lambda_n)}{2 \cdot \lambda_n + \sin(2 \cdot \lambda_n)} \cdot \cos(\lambda_n \cdot \xi) \cdot e^{-\lambda_n^2 \cdot \tau} \right)$$

Where the  $\lambda_n$ 's are solve using the constraint for the second boundary condition:

$$\lambda \cdot \tan(\lambda) = \frac{k_c \cdot L \cdot K}{D_{AB}}$$

The partition coefficient,  $K$ , can be found using graphs for the EMC values. At every relative humidity (RH) and temperature, there is specific concentration of water inside of sludge that corresponds to these conditions. This will, of course, be a non-linear function of  $C_A$ , but for the moment we can assume a linear profile by solving a least squares regression of the data. The diffusivity,  $D_{AB}$ , can be found in the literature for water in air at the specified temperature. The mass transfer coefficient,  $k_c$ , is found using the relationship for the Sherwood number. This function will be different for different geometries. The function in the paper is for a spherical pellet, so the other relation will have to be found and used.

If we assume that we know the value of "f", which corresponds to the RHS of the above equation, we can solve the for  $\lambda_n$  values. This is shown below for a "f" value equal to 0.01. The function we will use is:

$$\lambda \cdot \tan(\lambda) = 127000$$

$$\begin{aligned} \text{TOL} &:= 10^{-6} \\ \text{CTOL} &:= 10^{-6} \end{aligned}$$

Plotting this function and solving for the zeroes:

$$f(\lambda) := (\lambda \cdot \tan(\lambda) - 127000)$$

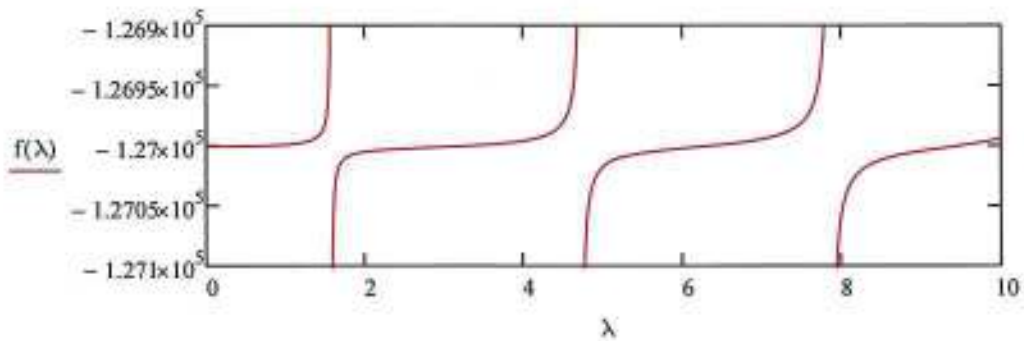

We can see that the solutions oscillate about once every 3.14 units of  $\lambda$  (i.e., 4 solutions per 10  $\lambda$ 's). Writing a function to solve for these values numerically, we can store them into a vector:

Dado

$$f(\lambda) = 0$$

$$G(\lambda) := \text{Find}(\lambda)$$

$$G(1.5708) = 4.71235$$

Now making a set of vectors for our guess values, we can get the solutions:

$$\text{Guess} := \begin{cases} B \leftarrow 0 \\ \text{for } i \in 0..200 \\ \quad B_i \leftarrow \pi \cdot i \\ B \end{cases}$$

$$\text{Sol} := \begin{cases} S \leftarrow 0 \\ \text{for } i \in 0..200 \\ \quad S_i \leftarrow (G_{\text{Guess}_i}) \\ S \end{cases}$$



Plotting these, we can see the trend:

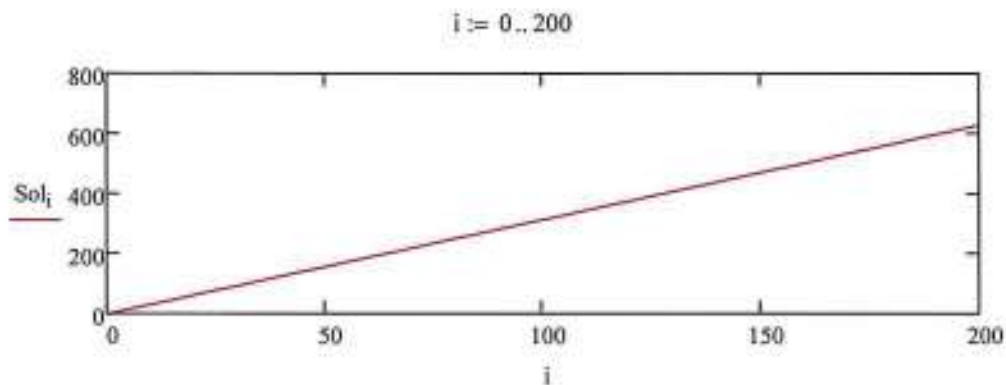

Now that we have our values for  $\lambda$ , we can place these into our equation for  $\chi$  and sum the series up to our end value for the  $\lambda$ 's (i.e., 200 in our case):

$$\chi = \sum_{n=0}^{200} \left( \frac{4 \cdot \sin(\lambda_n)}{2 \cdot \lambda_n + \sin(2 \cdot \lambda_n)} \cdot \cos(\lambda_n \cdot \xi) \cdot e^{-\lambda_n^2 \cdot \tau} \right)$$

Replacing our definitions for  $\chi$ ,  $\xi$ , and  $\tau$ , we can get a solution in terms of values that we are familiar with:

$$M_A(x,t) = M_{A\infty K} + (M_{A0} - M_{A\infty K}) \cdot \sum_{n=0}^{200} \left( \frac{4 \cdot \sin(\lambda_n)}{2 \cdot \lambda_n + \sin(2 \cdot \lambda_n)} \cdot \cos\left(\lambda_n \cdot \frac{x}{L}\right) \cdot e^{-\lambda_n^2 \cdot \frac{t D_{AB}}{L^2}} \right)$$

It is a trivial task now to determine what the values for  $C_{A0}$ ,  $C_{A=K}$ ,  $L$ , and  $D_{AB}$  and place them into this equation. Note that these solutions are based on  $\lambda$ , which was solved for a specific case of  $f = 2$ . If we make further assumptions for the sake of completing this exercise, we can plot the concentration profile as a function of time and location. Assuming the following:

$$M_{A0} := 5.604 \quad M_{AK} := 0.130 \quad \frac{L}{\sqrt{D_{AB}}} := 0.06 \quad D_{AB} := 7.41 \cdot 10^{-10}$$

We get the following final result and graph:

$$\lambda := \begin{pmatrix} 1.5708 \\ 4.7124 \\ 7.8540 \\ 10.9956 \end{pmatrix}$$

$$M_A(x,t) := M_{AK} + (M_{A0} - M_{AK}) \cdot \sum_{n=0}^3 \left[ \frac{4 \cdot \sin(\lambda_n)}{2 \cdot \lambda_n + \sin(2 \cdot \lambda_n)} \cdot \cos\left(\lambda_n \cdot \frac{x}{L}\right) \cdot e^{-\frac{(\lambda_n)^2 \cdot t \cdot D_{AB}}{L^2}} \right]$$

$$x := 0, 0.0001 \dots 0.06$$

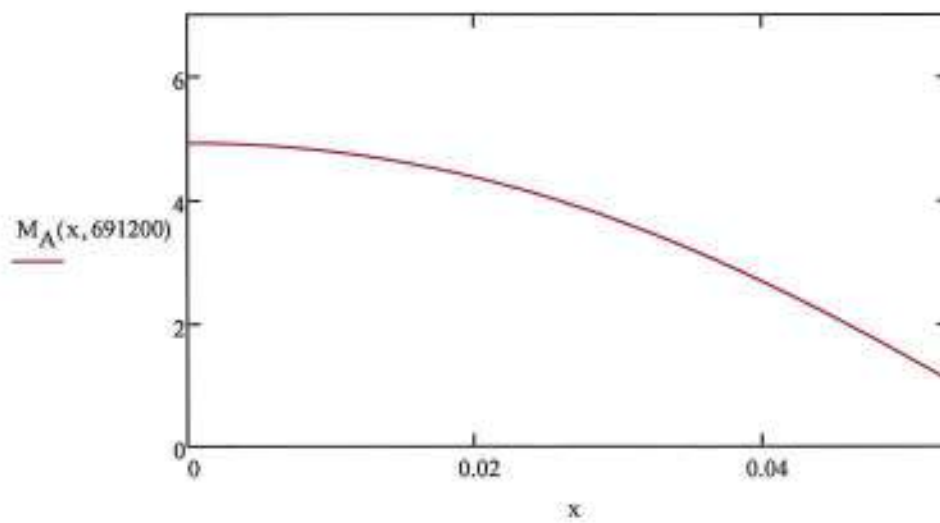

We can now plot the concentration profile in the sludge for various times. Notice the slight variations due to the numerical inaccuracy of the solution toward the end:

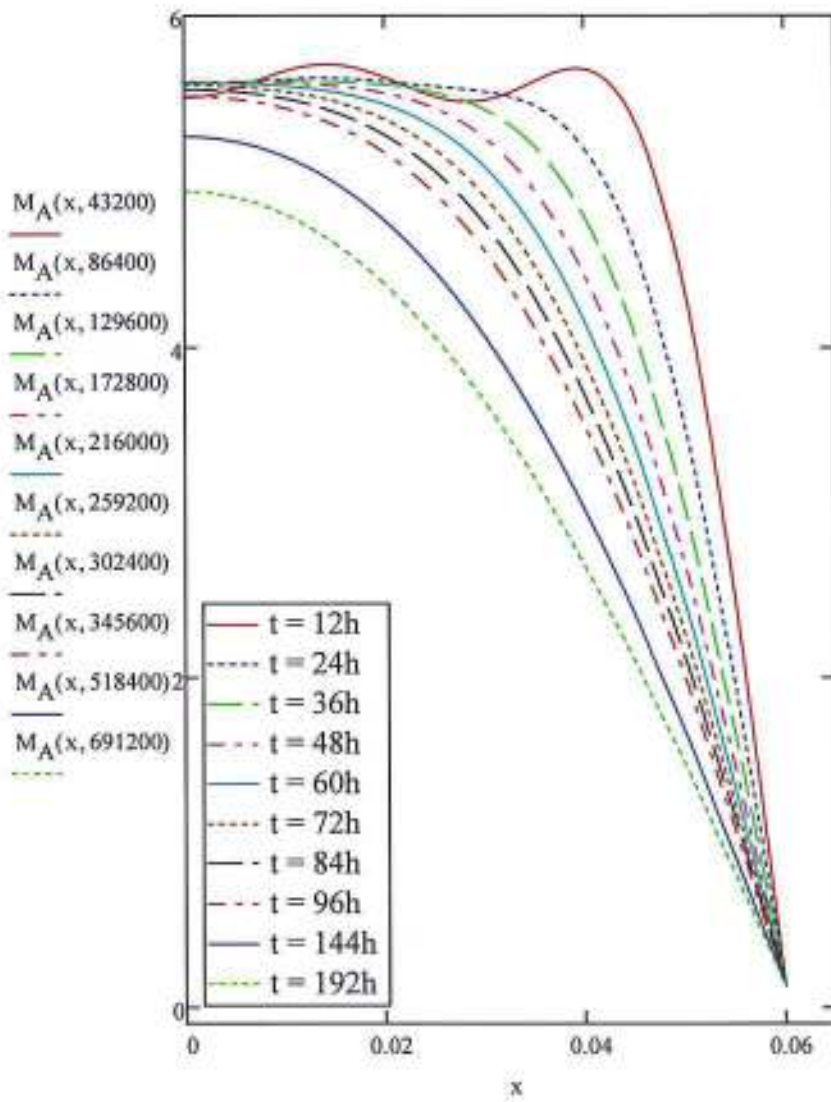

Now we can plot a x-t graph for many values of x

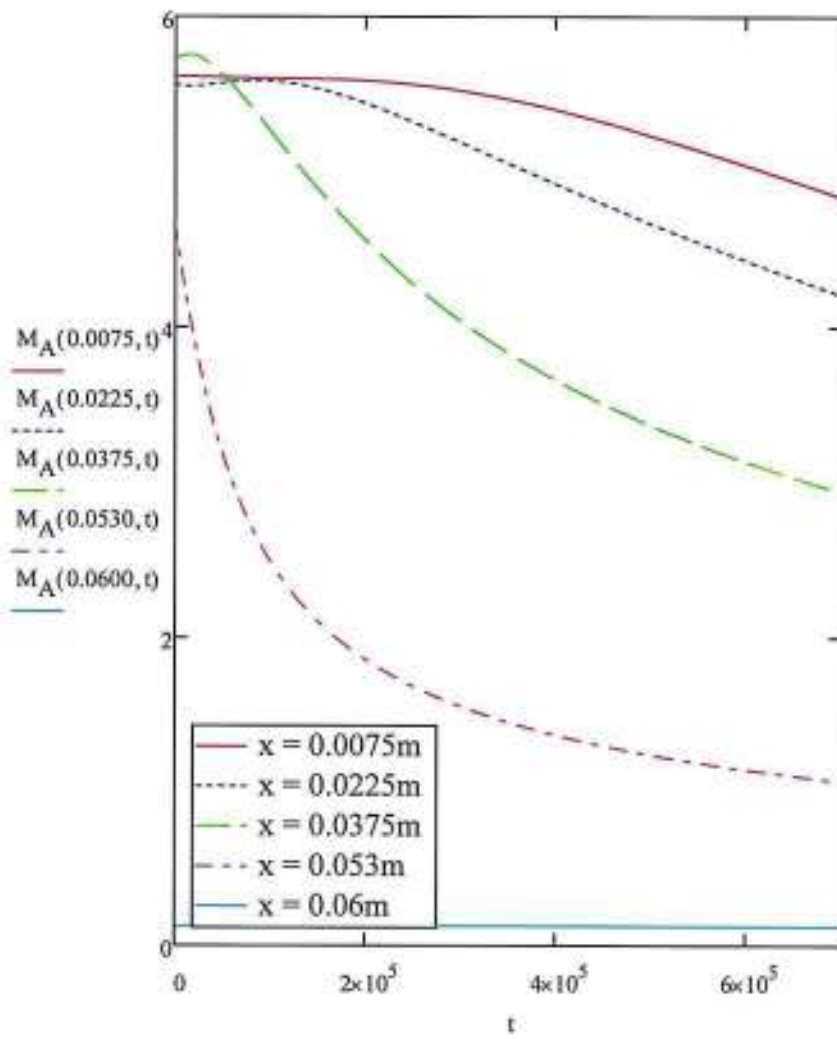

Now, we can plot the graphics about the correlation between experimental and simulated values of moisture.

$t :=$	$\begin{pmatrix} 0 \\ 43200 \\ 86400 \\ 129600 \\ 172800 \\ 216000 \\ 259200 \\ 302400 \\ 345600 \\ 518400 \\ 691200 \end{pmatrix}$	$M_A(0.0075, t) =$	$\begin{pmatrix} 5.61428 \\ 5.61307 \\ 5.60681 \\ 5.60378 \\ 5.59831 \\ 5.58484 \\ 5.5604 \\ 5.52424 \\ 5.47694 \\ 5.20389 \\ 4.86019 \end{pmatrix}$	$M_{exp1} :=$	$\begin{pmatrix} 5.565 \\ 5.297 \\ 5.580 \\ 5.419 \\ 5.343 \\ 5.635 \\ 5.689 \\ 5.640 \\ 5.689 \\ 5.464 \\ 5.211 \end{pmatrix}$
--------	---	--------------------	--	---------------	---

$$M_{call} := M_A(0.0075, t)$$

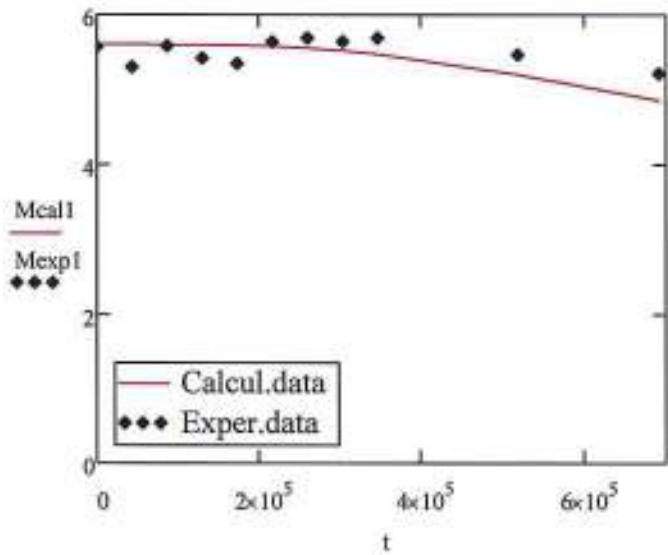

$$M_A(0.0225, t) = \begin{pmatrix} 5.56435 \\ 5.57019 \\ 5.58965 \\ 5.56484 \\ 5.49904 \\ 5.40638 \\ 5.29891 \\ 5.18473 \\ 5.0687 \\ 4.62417 \\ 4.22851 \end{pmatrix} \quad M_{exp2} := \begin{pmatrix} 5.487 \\ 5.494 \\ 5.387 \\ 5.468 \\ 5.457 \\ 5.328 \\ 5.421 \\ 5.515 \\ 5.408 \\ 4.898 \\ 4.074 \end{pmatrix}$$

$$M_{cal2} := M_A(0.0225, t)$$

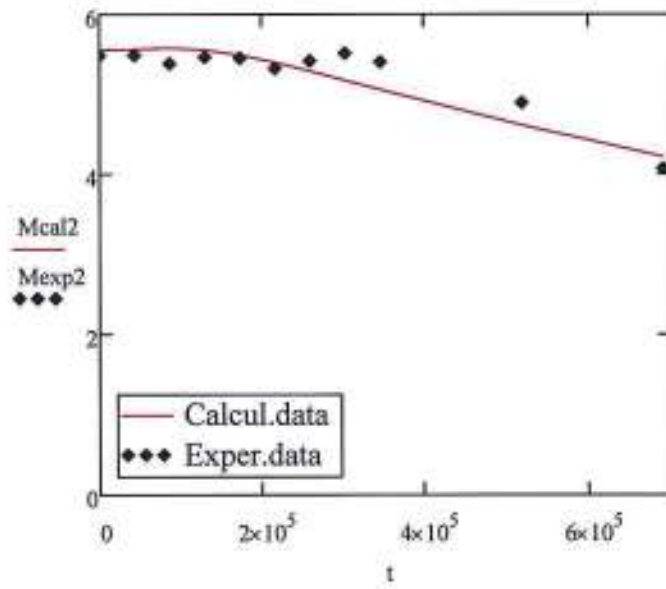

From here, two experimental values are considered as "out layers" due to lack of experimental repetitions:

$$M_A(0.0375, t) = \begin{pmatrix} 5.72485 \\ 5.66304 \\ 5.36546 \\ 5.03513 \\ 4.73019 \\ 4.46248 \\ 4.23019 \\ 4.02825 \\ 3.85151 \\ 3.31932 \\ 2.95258 \end{pmatrix} \quad M_{exp3} := \begin{pmatrix} 5.466 \\ 5.441 \\ 5.468 \\ 5.364 \\ 5.319 \\ 5.029 \\ 4.672 \\ 4.379 \\ 4.182 \end{pmatrix}$$

$$M_{cal3} := M_A(0.0375, t)$$

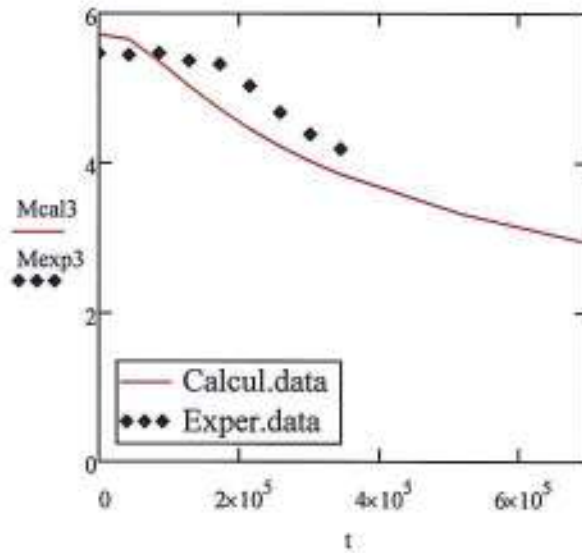

$$M_A(0.053, t) = \begin{pmatrix} 4.67452 \\ 3.33369 \\ 2.6438 \\ 2.24176 \\ 1.9806 \\ 1.79605 \\ 1.65733 \\ 1.54828 \\ 1.45966 \\ 1.22117 \\ 1.0758 \end{pmatrix} \quad M_{exp4} := \begin{pmatrix} 4.917 \\ 3.815 \\ 3.317 \\ 2.420 \\ 2.007 \\ 1.476 \\ 1.096 \\ 0.841 \\ 0.676 \end{pmatrix}$$

$$M_{cal4} := M_A(0.053, t)$$

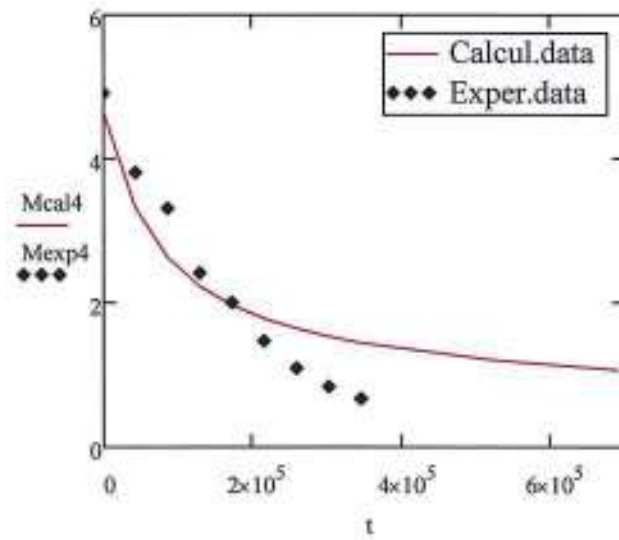





ORIGIN = 1

Errors can be calculated as follow.

$t :=$	$\begin{pmatrix} 0 \\ 0 \\ 43200 \\ 86400 \\ 129600 \\ 172800 \\ 216000 \\ 259200 \\ 302400 \\ 345600 \\ 518400 \\ 691200 \end{pmatrix}$	$Mexp1 :=$	$\begin{pmatrix} 1 \\ 5.565 \\ 5.297 \\ 5.580 \\ 5.419 \\ 5.343 \\ 5.635 \\ 5.689 \\ 5.640 \\ 5.689 \\ 5.464 \\ 5.211 \end{pmatrix}$	$Mcal1 :=$	$\begin{pmatrix} 0 \\ 5.61428 \\ 5.61307 \\ 5.60681 \\ 5.60378 \\ 5.59831 \\ 5.58484 \\ 5.5604 \\ 5.52424 \\ 5.47694 \\ 5.20389 \\ 4.86019 \end{pmatrix}$	$Mexp2 :=$	$\begin{pmatrix} 1 \\ 5.487 \\ 5.494 \\ 5.387 \\ 5.468 \\ 5.457 \\ 5.328 \\ 5.421 \\ 5.515 \\ 5.408 \\ 4.898 \\ 4.074 \end{pmatrix}$
--------	--	------------	--	------------	---	------------	--

$Mcal2 :=$	$\begin{pmatrix} 0 \\ 5.56435 \\ 5.57019 \\ 5.58965 \\ 5.56584 \\ 5.49904 \\ 5.40638 \\ 5.29891 \\ 5.18473 \\ 5.0687 \\ 4.62417 \\ 4.22851 \end{pmatrix}$	$Mcal3 :=$	$\begin{pmatrix} 0 \\ 5.72485 \\ 5.66304 \\ 5.36546 \\ 5.03513 \\ 4.73019 \\ 4.46248 \\ 4.23019 \\ 4.02825 \\ 3.85151 \\ 3.31932 \\ 2.95258 \end{pmatrix}$	$Mcal4 :=$	$\begin{pmatrix} 0 \\ 4.67452 \\ 3.33369 \\ 2.6438 \\ 2.24176 \\ 1.9806 \\ 1.79605 \\ 1.65733 \\ 1.54828 \\ 1.45966 \\ 1.22117 \\ 1.0758 \end{pmatrix}$
$Mexp3 :=$	$\begin{pmatrix} 1 \\ 5.466 \\ 5.441 \\ 5.468 \\ 5.364 \\ 5.319 \\ 5.029 \\ 4.672 \\ 4.379 \\ 4.182 \end{pmatrix}$	$Mexp4 :=$	$\begin{pmatrix} 1 \\ 4.917 \\ 3.815 \\ 3.317 \\ 2.420 \\ 2.007 \\ 1.476 \\ 1.096 \\ 0.841 \\ 0.676 \end{pmatrix}$		

```

Error := for k ∈ 1..rows(t)
|
| Error1,2 ← "x=0.0075m"
|
| Errork,2 ←  $\left| \frac{Mcal1_k - Mexp1_k}{Mexp1_k} \right|$ 
|
| Error13,2 ←  $\sum_{k=2}^{12} \left| \frac{Mcal1_k - Mexp1_k}{Mexp1_k} \right|$ 
|
| Error14,2 ←  $\frac{Error_{13,2}}{rows(t) - 1}$ 
|
| Error1,3 ← "x=0.0225m"
|
| Errork,3 ←  $\left| \frac{Mcal2_k - Mexp2_k}{Mexp2_k} \right|$ 
|
| Error13,3 ←  $\sum_{k=2}^{12} \left| \frac{Mcal2_k - Mexp2_k}{Mexp2_k} \right|$ 
|
| Error14,3 ←  $\frac{Error_{13,3}}{rows(t) - 1}$ 
|
| for k ∈ 1..rows(t) - 2
|
| | Error1,4 ← "x=0.0375m"
|
| | Errork,4 ←  $\left| \frac{Mcal3_k - Mexp3_k}{Mexp3_k} \right|$ 
|
| | Error13,4 ←  $\sum_{k=2}^{rows(t)-2} \left| \frac{Mcal3_k - Mexp3_k}{Mexp3_k} \right|$ 
|
| | Error14,4 ←  $\frac{Error_{13,4}}{rows(t) - 3}$ 
|
| | Error1,5 ← "x=0.0530m"
|
| | Errork,5 ←  $\left| \frac{Mcal4_k - Mexp4_k}{Mexp4_k} \right|$ 
|
| | Error13,5 ←  $\sum_{k=2}^{rows(t)-2} \left| \frac{Mcal4_k - Mexp4_k}{Mexp4_k} \right|$ 
|
| | Error14,5 ←  $\frac{Error_{13,5}}{rows(t) - 3}$ 

```

```

Error13,1 ← "Tot Error"
Error14,1 ← "Averag Error"
Error11,4 ← "-"
Error12,4 ← "-"
Error11,5 ← "-"
Error12,5 ← "-"
Error

```

	1	2	3	4	5
1	0	"x=0.0075m"	"x=0.0225m"	"x=0.0375m"	"x=0.0530m"
2	0	$8.855 \cdot 10^{-3}$	0.014	0.047	0.049
3	0	0.06	0.014	0.041	0.126
4	0	$4.805 \cdot 10^{-3}$	0.038	0.019	0.203
5	0	0.034	0.018	0.061	0.074
6	0	0.048	$7.704 \cdot 10^{-3}$	0.111	0.013
7	0	$8.902 \cdot 10^{-3}$	0.015	0.113	0.217
8	0	0.023	0.023	0.095	0.512
9	0	0.021	0.06	0.08	0.841
10	0	0.037	0.063	0.079	1.159
11	0	0.048	0.056	"_"	"_"
12	0	0.067	0.038	"_"	"_"
13	"Tot Error"	0.359	0.345	0.645	3.194
14	"Averag Error"	0.033	0.031	0.072	0.355

Error =

