

**A BIM BASED-TOOL FOR FORMWORK MANAGEMENT IN BUILDING
PROJECTS**

by

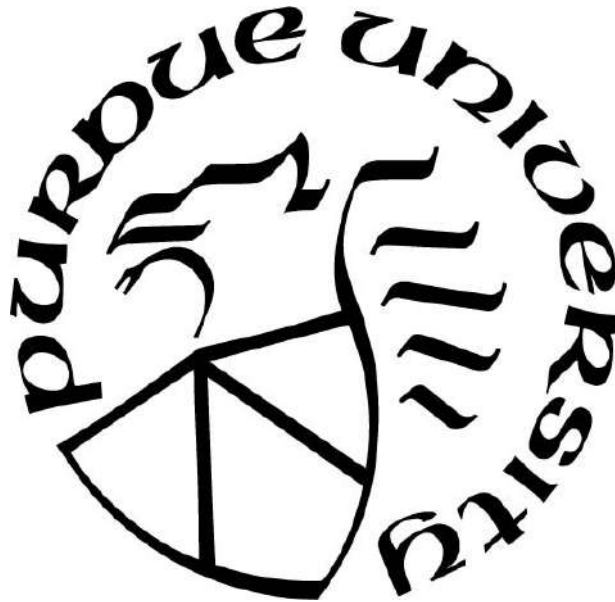
Jorge Alfredo Rojas Rondan

A Thesis

Submitted to the Faculty of Purdue University

In Partial Fulfillment of the Requirements for the degree of

Master of Science in Civil Engineering



Lyles School of Civil Engineering

West Lafayette, Indiana

May 2021

**THE PURDUE UNIVERSITY GRADUATE SCHOOL
STATEMENT OF COMMITTEE APPROVAL**

Dr. Dulcy M. Abraham, Chair
Lyles School of Civil Engineering

Dr. Hubo Cai
Lyles School of Civil Engineering

Dr. Bobby G. McCullouch
Lyles School of Civil Engineering

Approved by:

Dr. Dulcy M. Abraham

Dedicated to the Fulbright Commission from Peru who gave this once in life experience of studying abroad, to Purdue University for funding my studies, to the National University of Engineering of Peru for giving me the opportunity to become an engineer and to all my family that fuel me every day for being a better person.

ACKNOWLEDGMENTS

I would like to express my endless gratitude and admiration to my advisor Professor Dulcy M. Abraham, Professor and Graduate Chair, Burke Graduate Program, Lyles School of Civil Engineering, for her patience, dedication, and guidance through the entire program and specially during the development of this thesis. This thesis would not have been possible without her support and constant motivation for improving myself and encouraging me to always look for the excellence and having an impact in the industry.

Also, I would like to thank Professor Bobby McCullough for always having an open door and sharing all his knowledge in construction engineering, but most important for sharing his valuable time even outside of the classroom. I want to express my gratitude and admiration for his incredible quality as a professor, as an engineer but even more as a generous and kind person who is always willing to help others.

I would like to thank Professor Hubo Cai for developing my interest in using digital technologies applied for construction, and for always been willing to answer my doubts to continue getting me more involved in the use of BIM and GIS in my professional career.

Also, I would like to thank all the AEC practitioners who participated in the survey conducted for this research, specially for Santiago Hidalgo, Alexis Romero, Javier Luna, Alex Roy, Karin Concha, Carlos Vizurraga, and Milton Valer who kindly accepted to be interviewed as formwork experts. My deepest sympathy to the family members of my friend Francisco Carrillo who participated also as a formwork expert but passed away this year before the culmination of this thesis.

TABLE OF CONTENTS

LIST OF TABLES	7
LIST OF FIGURES	8
ABSTRACT	12
1. INTRODUCTION	14
1.1. Background and Research Motivation	15
1.2. Problem Statement.....	18
1.3. Research Questions	19
1.4. Research Objective.....	20
1.5. Research Framework.....	20
1.6. Research Methodology.....	21
1.7. Research Methodology.....	23
2. REVIEW OF THE STATE OF THE ART AND STATE OF PRACTICE IN FORMWORK MANAGEMENT.....	25
2.1 Formwork management in building projects	25
2.1.1 Formwork layout planning and work zones planning	26
2.1.2 Formwork systems.....	33
2.1.3 Formwork rental options.....	35
2.1.4 Formwork demand profile	38
2.1.5 Cost analysis of formwork.....	39
2.1.6 Formwork control with KPIs	41
2.2 Previous research studies related to formwork management.....	43
2.3 Developments in formwork management	45
2.3.1 Formwork management using CAD.....	46
2.3.2 Formwork management using BIM.....	48
2.4 Needs assessment.....	49
2.5 Summary	54
3. RESEARCH METHODOLOGY	55
3.1. BIM workflow automation.....	55
3.2. Road map for developing the framework for formwork management using BIM.....	58

3.3.	BIM parameters management.....	60
3.4.	Auditing the BIM model for formwork management	71
3.5.	Work zoning process using BIM.....	75
3.6.	Formwork modeling automation	78
3.7.	Populating parameters using Dynamo.....	81
4.	EVALUATION OF THE FORMWORK MANAGEMENT TOOL	93
4.2.	Roadmap for using the BIM-based formwork management tool.....	93
4.3.	Generation of schedules and quantities	96
4.4.	Formwork cost analysis & KPIs.....	98
4.4.1.	Quantities takeoff summary for RC structure components.....	98
4.4.2.	Quantities takeoff summary for formwork solution systems.....	100
4.4.3.	Maximum formwork set size by formwork solution system.....	101
4.4.4.	Formwork management KPIs.....	105
4.5.	Formwork demand profile.....	109
4.6.	4D and 5D simulations	112
4.7.	Generation of layout color mapping views and plans.....	113
4.8.	Description of case studies	114
4.9.	Comparison of results of case studies	116
4.10.	Summary	117
5.	CONCLUSIONS	119
5.1.	Summary of the Research Process	119
5.2.	Research Conclusions.....	120
5.3.	Limitations of the Research.....	122
5.4.	Contribution to the Body of Knowledge	123
5.5.	Contribution to the Body of Practice.....	124
5.6.	Recommendations for Future Research.....	124
	REFERENCES	126

LIST OF TABLES

Table 2.1. Labor productivity values	33
Table 2.2. QTO ratios per square construction area	33
Table 2.3. Typical formwork bid proposal	36
Table 2.4. Previous research studies related to formworks.	44
Table 3.1. Dynamo and Add-Ins trade-off.....	57
Table 3.2. Parameters' groups	60
Table 3.3. MOD Parameters - Group: MODEL	62
Table 3.4. Productivity Parameters.....	66
Table 3.5. Time parameters	66
Table 3.6. Formwork parameters	67
Table 3.7. Cost parameters.....	68
Table 3.8. Default steel ratios	83
Table 3.9. Weight ratios for formwork solutions.....	86
Table 3.10. Productivity indexes references	87
Table 3.11. Referential ratios of cost for estimating consumables.....	88
Table 3.12. Rates for renting formwork solution systems	90
Table 3.13. Rates for renting beam lateral formwork solution systems	90
Table 4.1. Main features of two sample buildings.....	115

LIST OF FIGURES

Figure 1.1. Formwork management map (PRES).....	19
Figure 1.2. BIM Framework Methodology for formwork Management.....	23
Figure 2.1. Formwork layout and work zones planning.....	26
Figure 2.2. Lookahead schedule for 1st story of 10-story building.....	28
Figure 2.3. Lookahead for 10-story building.....	29
Figure 2.4. Program chart and objective chart for 10-story building.....	29
Figure 2.5 Elevation view and 3D view of typical parts and stories of a building to define main layout plans.....	31
Figure 2.6 Formwork Systems Map. Adapted from (Jimenez, 2020)	34
Figure 2.7. Formwork rental options map.	37
Figure 2.8. Formwork demand profiles	38
Figure 2.9. Formwork element used as a work platform.....	39
Figure 2.10. Surplus formwork partially buried on site.....	39
Figure 2.11. Cause effect of formwork extra cost	41
Figure 2.12. Formwork management KPIs for building projects	43
Figure 2.13. ELPOS from Peri.....	48
Figure 2.14. Doka CAD 9 from Doka.....	48
Figure 2.15. Integration of PERI CAD in the BIM process.....	48
Figure 2.16. Doka CAD for Revit.....	49
Figure 2.17. Country of participants.....	50
Figure 2.18. Years of experience of participants	50
Figure 2.19. Professional profile of participants.....	50
Figure 2.20. Level of Development (LOD) for a column formwork.....	51
Figure 2.21. LOD preference of general contractors and formwork providers	52
Figure 2.22. Formwork rental option preference.....	53
Figure 2.23. Computational tools preferred by general contractors for formwork management.	53
Figure 2.24. Level of automation preference by contractors and formwork companies	54
Figure 3.1. Dynamo workflow for reshoring cost sum for all horizontal elements.....	56

Figure 3.2. Road map for generating a BIM model for formwork management.....	59
Figure 3.3. Hierarchy of Category, Family, Type, and Instance	61
Figure 3.4. Parameter properties.....	61
Figure 3.5. Renaming of levels for formwork analysis	63
Figure 3.6. Joint element type parameter.....	63
Figure 3.7. Column poured until beam bottom.....	64
Figure 3.8. Wall poured until slab bottom	64
Figure 3.9. Doka beam lateral formwork with ties	65
Figure 3.10. Doka beam lateral formwork with bracing squares.....	65
Figure 3.11 Formwork consumables.....	69
Figure 3.12. Shared Parameters txt file.....	69
Figure 3.13. Dynamo Script for creating shared parameters from an Excel file.	70
Figure 3.14. Results of running Dynamo Script for creating shared parameters.....	70
Figure 3.15. Result of running script for creating project parameters	71
Figure 3.16. Floor priority over beams and columns.....	72
Figure 3.17. Column priority over the floor and beams	72
Figure 3.18. Results of running Dynamo script to switch element priorities	72
Figure 3.19. RC column and steel beam connection	73
Figure 3.20. Monolithic structure with tunnel formwork	73
Figure 3.21. Results of Dynamo script for splitting columns.....	74
Figure 3.22. Results of Dynamo script for splitting walls.....	74
Figure 3.23. Dynamo Script for splitting all columns in the BIM model.....	75
Figure 3.24. Work zone leveling using Parts and multicategory schedules	76
Figure 3.25. Results of running Dynamo script for work zoning	77
Figure 3.26. Dynamo Script for work zoning elements.....	78
Figure 3.27. Dynamo script for creating materials.	79
Figure 3.28. Results of running Dynamo script for creating materials.....	79
Figure 3.29. Dynamo script for modeling and calculating the formwork area of a foundation. ..	80
Figure 3.30. Dynamo view of the surfaces that represent the formwork for a foundation.....	80
Figure 3.31. Results of running Dynamo script for modeling formworks.....	81

Figure 3.32. Dynamo script for populating MOD parameters.....	82
Figure 3.33. Results of running Dynamo script for populating MOD parameters	82
Figure 3.34. Results of running MOD, TIME, and STEEL Dynamos scripts.....	83
Figure 3.35. Schedule generated in MS Project to estimate stripping dates.....	84
Figure 3.36. VBA Excel Macro for creating Schedule Structure of activities to generate MS project schedule.....	84
Figure 3.37 Result of running Dynamo Script for populating dates and time.....	85
Figure 3.38. Dynamo Script for getting dates and durations.	85
Figure 3.39. Results of running "Weight ratios" script.....	86
Figure 3.40. Dynamo script for estimating formwork weight for foundations.....	86
Figure 3.41. Results of running Dynamo script for filling up PROD parameters	87
Figure 3.42.Dynamo Script for estimating labor hours.	88
Figure 3.43. Dynamo script for estimating consumable cost.....	89
Figure 3.44. Results of running script for estimating formwork consumables cost	89
Figure 3.45. Dynamo Script for estimating renting cost of column formwork.	91
Figure 3.46. Results of running script for estimating formworks renting costs	91
Figure 3.47. Flowchart for using Dynamo Scripts and Excel files.....	92
Figure 4.1. Roadmap for second phase of the BIM-based formwork management tool.....	95
Figure 4.2. Multi-Category option for creating a new quantities list/schedule	97
Figure 4.3. Result of creating a Multi-Category schedule	97
Figure 4.4. Creating a New Material Takeoff schedule.....	98
Figure 4.5. Results of creating a New Material Takeoff schedule.....	98
Figure 4.6. Dynamo script for computing quantities summary for entire project	99
Figure 4.7. Results of running Dynamo script for computing quantities summary.....	99
Figure 4.8. Dynamo script for generating formwork summary.	101
Figure 4.9. Results of running Dynamo script for formwork summary.	101
Figure 4.10. Analysis for computing foundations maximum formwork set size.....	103
Figure 4.11. Dynamo script for computing the maximum formwork set size for foundations. .	103
Figure 4.12. Maximum formwork set size for foundations	104
Figure 4.13. Results of running Dynamo script for computing maximum formwork set size. ..	105

Figure 4.14. Dynamo script for computing KPIs report	108
Figure 4.15. Results of running Dynamo script for computing KPIs.	109
Figure 4.16. Workflow for interoperability of information between Revit - Excel and Project for generating formwork curve.....	109
Figure 4.17. Dynamo script for exporting formwork rental cost grouped by work zone code. .	110
Figure 4.18. Results of running Dynamo script for exporting formwork and reshoring rental cost grouped by work zone into an Excel file.	110
Figure 4.19. Excel table reorganizing the cost column based on the "activity sequence structure" of the schedule template.....	111
Figure 4.20. MS Project schedule with the cost column filled in with the excel values.	111
Figure 4.21. Task Usage view for the cash flow of the formwork renting cost.....	111
Figure 4.22. Formwork demand profile	112
Figure 4.23. Dynamo Script for generating XML file for generating Sets in Navisworks.....	113
Figure 4.24. 4D and 5D simulation process.....	113
Figure 4.25. 3D view filtered by work zone.	114
Figure 4.26. 3D view filtered by element type	114
Figure 4.27. 3D filtered view for tracking stripping dates.....	114
Figure 4.28. Layout plan view for two sample buildings	115
Figure 4.29. BIM Process Phase 1 for 20-story building and 5-story building	116
Figure 4.30. Results of running Dynamo script for calculating KPIs.....	116
Figure 4.31. BIM-based formwork management Phase 2: Tools' workflow	118

ABSTRACT

Formwork represents between the 35% and the 60% of the total cost of the structural framing of a concrete building and is always part of the critical path of a project. Building Information Modeling (BIM) has been growing rapidly worldwide for building projects. However, modeling temporary structures using BIM is not very common. The current formwork management practice relies on the use of traditional tools like CAD, PDF editors and spreadsheets. A BIM formwork model during the preconstruction stages provides a powerful tool for decision making in formwork management (selecting formwork system, formwork supplier, and defining quantities to procure formwork systems). Relying only on rough cost estimates and field experience related to formwork can lead to like overestimating formwork budgets, renting surplus formwork, and paying for additional formwork elements/systems that are in jeopardy of being lost, damaged or even stolen. A review of the state of art, the state of practice and the results of survey used to gather data about AEC practitioners regarding formwork management preferences, indicated that: (1) BIM formwork modeling with LOD 100 and 200 is the preferred approach by practitioners, (2) renting formwork is the preferred mode, considering the contact area of the system instead of renting pieces of formwork, and (3) the use of traditional tools like CAD, PDF editors and spreadsheets involving minimum level of automation, is the general practice in formwork management. Based on these findings the thesis focuses on the design, development and testing of a BIM-based formwork management tool.

The BIM-based tool has two phases: (1) the automation of BIM formwork modeling of the contact surface of formwork systems and populating BIM parameters related to formwork (formwork types, formwork weight, productivity, and timing) in the input BIM model, and (2) use of the resulting BIM model developed in phase 1 for formwork management tasks (quantity takeoffs, formwork demand profiles, cost analysis, estimation of Key Performance Indicators (KPIs) like reuse factor and formwork efficiency, and tracking formwork removal). The tool was tested on two case studies (a 20-story building and a 5-story building) both with 80 work zones and 46,650 m² of floor-built area. The results of the KPIs for both case studies were similar as expected since both buildings have similar modular architectures. The BIM-based tool for formwork management presented in this thesis provides the following advantages: (1) Implemented independently of the formwork systems or formwork provider selected, (2) Time savings due to automation of repetitive

tasks in Revit and focus on modeling formwork surface contact area (instead of modeling all formwork components), and (3) Reduction in human error since the BIM processes (formwork modeling, parameters management, and exchange of data between different platforms) are automated, reducing the need of manual entry of parameter values or manual 3D modeling.

1. INTRODUCTION

One of the main structural materials used for the construction of buildings is Reinforced Concrete (RC). In the case of tall buildings (more than 75 ft height according to (NFPA, 2011)), the global percentage of steel structure construction fell from 90% in 1970 to only 17% in 2013, pointing to the increase in the use of concrete or composite materials in tall buildings. This increased use of RC in tall buildings is even more dominant in developing countries, where there is greater expertise using reinforced concrete rather than using steel (Wood & Parker, 2013).

According to (Ko, Wang, & Kuo, 2011) the primary materials involved in RC buildings are: reinforcing steel (rebar), formwork, rough-in conduits, and concrete. In a traditional project delivery system, the quantities of concrete, conduits and rebar are defined by the designer, with little room for improvement by the contractor, but formwork is still a responsibility of and defined by the contractor (Peurifoy & Oberleder, 2011). Formwork is a key consideration for contractors since it is a labor-intensive activity, and the efficiency of the process depends on the selection of the appropriate reuse schedule (rotation) of forms (Huang, Chen, & Sun, 2004).

Formwork management involves preparing an accurate estimate of quantities that will be used for measuring the formwork installation performance and comparing this performance with the project baseline (schedule, cost, and scope). Proper estimation of formwork quantities improves the production on site, reduces the amount of waste, and ensures that equipment and tools used for the installation and removal are appropriate and used efficiently at different locations. The proper estimation of quantities is used for preparing the optimum formwork reuse schedule to minimize idle material (reduce waste) and improve the construction flow (add value) of the building structure, which is commonly on the critical path of the project.

Traditionally, the estimation of formwork quantities was done using tools such as spreadsheets, CAD tools or PDF editors. The use of these tools is time consuming, and the manual process is often prone to human error. The advent of Building Information Modeling (BIM) provides opportunities for determining quantities of every component of a building (if it is included as part of the BIM model), in a fraction of time. Since formwork is a temporary structure, formwork elements are rarely included in the BIM model, and direct determination of formwork quantities from current BIM models is difficult. Hence, a detailed formwork breakdown is required for formwork management. Current BIM tools can be integrated with Lean principles like *create flow*

and *establish pull* to develop strategies for more reliable formwork management, leading to more reliable and automated process for determination of formwork quantities and installation strategies.

1.1. Background and Research Motivation

According to (Wood & Parker, 2013) RC is the preferred building material for tall buildings in developing countries. As an example, in countries like Taiwan, 87% of the total building floors were built with RC in the past five decades (Huang, Chen, & Sun, 2004). Formwork by itself is the largest cost component of the RC structure, often ranging in values between 35% and 60% of the total cost of the structural frame (Johnston, 2014).

There is a large variety of formwork alternatives considering materials, suppliers, types of elements to cast in or crane dependency, and the selection will depend on multiple criteria. The two types of formwork based on the place where the forms are prepared are: (1) prefabricated modular formwork, that is prepared off site, and (2) tailor-made formworks, which are prepared onsite. The common practice nowadays is to use prefabricated modular formwork systems. There are multiple advantages for using such prefabricated systems : (1) less labor activity on the jobsite, (2) easy access to engineering and technical support from the supplier, (3) quicker initiation of the work with a readily available system, (4) European certifications such as AFNOR, GSV and BS of many formwork manufacturers, (5) greater durability of materials due to more stringent quality control offsite, (6) fewer pieces systems, and (7) better productivity with less skilled labor (Huang, Chen, & Sun, 2004) .

There are several options for procuring pre-manufactured formwork for a project: (1) using the contractor's own formwork, (2) renting formwork from a manufacturer, supplier or renting company, (3) leasing the equipment, and at the end of the lease owning the formwork, or (4) hiring the services for tailor-made formwork based on special requirements. The rental option is often considered to be the most attractive alternative in building projects since: (1) it involves minor initial investment, (2) there is reduced risk for the investment in case of fluctuation in the market, (3) outsourcing of the engineering and shop drawings ensures that the contractor is not tasked with these activities, (4) there is greater flexibility for increasing or decreasing production capacity, (5) there is economy of scale in case formwork assemblies/systems are depreciated, (6) only required materials are brought to the construction site, reducing waste, (7) there is opportunity to obtain the latest technology, and (8) there is access to technical support from the supplier (Johnston, 2014). According to (Krawczynska-Piechna, 2016), less than the 6% of contractors own enough

formwork to perform their projects without renting extra formwork, and more than the 40% of contractors rent all the formwork they require for projects.

According to (Mansuri, Chakraborty, Elzarka, & Deshpande, 2017), BIM can be used during the construction phase for quantity take-off, cost estimation, early identification of design errors through clash detection, construction planning, 4D and 5D simulation, tracking construction progress, automation of shop drawings for prefabrication and modularization, and safety planning. Despite of these advantages of using BIM, in current projects it is not common to include temporary structures (including formwork) as part of the BIM models. Not including formwork elements as part of the BIM model creates difficulty in implementing BIM for formwork management (Gambatese & Jin, 2019). To address some of the challenges in the current formwork management practices, this thesis focuses on the conceptualization, design, development, and testing (with two case studies) of a BIM-based tool for formwork management in building projects without the need to model a specific formwork system with all its components. This research only considers the use of prefabricated modular formwork under the rental option since it is the preferred practice in the industry.

Importance of formwork for building projects

According to (Huang, Chen, & Sun, 2004), formwork is considered a critical activity for every RC building, and will have a great impact in terms of cost, time, quality, and safety. Formwork is the largest cost component of a RC structure, and even in some cases, could be even larger than the combined cost of concrete and rebar. Proper consideration to formwork design, planning and management could lead to savings greater than the 25% of the structural frame cost (Peurifoy & Oberleder, 2011). The time for stripping, preparing for the next use, hauling to the next work zone, and erecting the formwork, is considerably greater than concrete placement or steel erection. Typically, formwork activity is part of the critical path of a building project, so any reduction in the time of this activity will have direct impact on the total duration of the project (Peurifoy & Oberleder, 2011). The proper selection of formwork surface grade will have direct impact in the concrete surface quality, and any premature removal of forms or shoring could generate excessive cracking or deflections that will affect project's quality (ACI Committee 347, 2014). According to (Sohoni, Mittal, Matsagar, & Jha, 2020), most of the construction failures are related with inadequate shoring procedures and related to formwork, commonly because of excessive construction loads.

State of practice: Formwork management

There are multiple ways to improve formwork efficiency: (1) considering the standardization of the dimensions of concrete elements to avoid formwork disassembly, (2) selecting the best reuse scheme in order to use less formwork and utilize higher rotation of formwork, (3) selecting the best formwork option considering the balance between formwork surface grade and the posterior surface preparation of the concrete element, (4) selecting materials with better durability, (5) and selecting the formwork system with less amount of pieces that requires less labor work (Huang, Chen, & Sun, 2004). Project designers address standardization while considering not just the optimization of materials' quantities but also reducing the variability of element dimensions, to increase productivity during construction. Selecting formwork systems based on concrete surface preparation, productivity of formwork installation crews, and durability of materials used for formwork components has been extensively studied in the literature. However, there is not much literature related to the selection of the best formwork reuse scheme, and the industry practice is reliance on contractor experience often without the support of tools for automating formwork planning and management tasks (Biruk & Jaskowski, 2016).

State of practice: BIM for formworks

Designers and contractors pay more attention to permanent elements of a building, and since BIM modeling is a time-consuming process, typically temporary structures are not included as part of BIM models (Hyun, Jin, Shen, & Kim, 2018). According (McGraw Hill Construction, 2014), across developed regions (i.e., USA, Canada, Germany, France, UK, Japan, Australia, etc.), 60% of contractors operate at light or medium BIM implementation (i.e., 30% or fewer of their projects involve using BIM). In these developed regions, only 23% of the concrete subcontractors were rated by their general contractors as having high or very high proficiency in the use of BIM. According to (Jung & Lee, 2015), in developing regions like South America, 71.4% of BIM users evaluated themselves as “advanced” or “expert”. Focusing on developing regions where RC is the preferred structural material for buildings, some studies like the one developed by (Murguía, 2018) in Peru, 60% of building projects do not implement BIM or implement BIM model elements that have a minimum Level of Development (LOD), and 93% of buildings that use BIM only model the concrete structure as a volumetric 3D model, and formwork or rebar are not included in such models. According to (Mansuri, Chakraborty, Elzarka, & Deshpande, 2017) some challenges found during the implementation of BIM models for formworks in USA are as follows: (1) BIM

models for formwork are prepared after the BIM model of the structure is completed and after the formwork supplier is defined, (2) updating the formwork BIM model is challenging since design changes occur very frequently in building projects, and (3) formwork modeling and layout generations are not completely finished before concrete activities begin.

1.2. Problem Statement

Four themes can be explored when considering formwork optimization (Productivity - Reuse - Economy - Standardization (PRES)): (1) selecting the best formwork option that maximizes labor productivity by reducing the number of pieces needed, speeding up the erection and stripping processes, and reducing the number of workers required for handling formwork pieces, (2) maximizing the reuse of formwork with minimal use of equipment, (3) selecting the best option of formwork equipment that maximizes the economy of the assembly, and (4) defining the structure with the sufficient standardization to minimize the number of typologies of formwork systems considering constructability (Johnston D. W., 2014).

Most formwork companies view “Productivity” (P) as “making more with less”, which in formwork management implies increasing load capacities with fewer pieces and using light-weight formwork for easier transportation and assembly. In case of the formwork “Reuse” (R) contractors understand that by using Lean principles it is possible to reduce the quantities of “idle” material through workload leveling and using BIM can assist in to increasing the reliability and speed of computations for formwork scheduling and management. The “Economy” (E) theme is addressed with formwork design and selection, typically using modular prefabricated formwork systems and the renting option that provides flexibility along with low initial investment cost and access to the latest formwork technology. Finally, the “Standardization” (S) theme regarding the “constructability” is related to the involvement of the contractor experience during the design phase. In “Design Bid Build” (DBB) projects the contractor is not involved or has very little involvement with the design definition. These days, project delivery methods such as Integrated Project Delivery (IPD), Construction Management at Risk (CM@R) or Design Built (DB) include more input from contractors during the design phase, and as result, expertise related to formwork management can be considered during the definition and design of structural framing.





FORMWORK MANAGEMENT MAP				
	Productivity	Reuse	Economy	Standardization
PROBLEM	Formwork is labor intensive.	Manual and time-consuming planning process.	Find best load capacity with less formwork components.	DBB does not involve contractor experience.
SOLUTION	Consider formwork systems with fewer pieces.	Use of Lean principles (maximize value & reduce waste) and BIM methodology	Renting modular prefabricated formwork with latest technology available.	Collaborative delivery systems like IPD ensure better standardization and constructability.
STATUS	Industry oriented to develop industrialized systems.	Lack of methodologies available in literature for formwork management	Formwork companies oriented to develop best engineering solutions and systems.	Practitioners understands better the importance of standardization in construction.
				

Figure 1.1. Formwork management map (PRES)

1.3. Research Questions

The review of the state of art and the state of practice related to formwork indicates that prior research has focused on design, constructability, and selection criteria for formwork, but not on formwork planning and management. Formwork management involves complex tasks such as: (1) workload leveling for reducing idle time of crews, (2) computing formwork quantities, (3) defining formwork schedules, and (4) defining the best formwork reuse scheme for getting best formwork efficiency. All these tasks have challenges such as: (1) high probability of human errors since most of the tasks are manually done using CAD or PDF software with spreadsheets, (2) BIM tools are not commonly used for formwork since modeling of temporary structures is time-consuming and associated with additional investment, and (3) traditional tools like CAD and PDF editors require engineers to invest considerable time for selecting formwork reuse schemes, formwork systems or suppliers. Considering the challenges, the thesis addresses the following research questions:

1. What is the most appropriate Level of Development (LOD) for formwork management using BIM tools considering current practitioners' preferences in building projects?
2. What is the appropriate rental option for managing formwork through different project phases (initiation, planning, execution, control, and closure) considering current practitioners' preferences in building projects?
3. Based on current practices, how can formwork management tasks (e.g., workload leveling, quantity takeoff computation, defining reuse scheme and schedules) be more automated?

1.4. Research Objective

Based on the research questions listed in Section 1.3, the research objective of this study is to design, develop, and test a BIM-based tool for formwork management in building projects. The design of the BIM-based tool involves assessing practitioners' preference related to LOD for formwork modeling, rental options, and level of automation for formwork management tasks, and then uses practitioners' preferences (regarding LOD, rental option and automation) for defining BIM parameters to store data for future analyses related to formwork management. The development of the BIM-based tool is a two-phase process. The first phase is the automation of the modeling process of a formwork BIM model enriched with data necessary for performing formwork management. The second phase is focused on using the BIM model from the first phase for automating formwork management tasks such as: (1) creating a formwork schedule, (2) performing formwork cost analysis, and (3) computing three formwork Key Performance Indices (KPIs) (formwork total cost rate (USD\$/m²), reuse factor (number of uses/number of formwork sets) and formwork efficiency (formwork quantity/formwork rented). The BIM-based tool is tested on two case studies (twenty-story building and five-story-building with the same constructed area), and the KPIs for formwork management on these projects are compared.

1.5. Research Framework

Based on a synthesis of prior studies in formwork management and review of current practices in building projects, the proposed tool uses Lean principles (*create flow* and *establish pull*) and BIM methodology for the automation of formwork scheduling, cost analysis, and determination of KPIs. The BIM-based tool is executed in Revit 2020, the most popular BIM software package currently used in the AEC industry. Dynamo 2.1.0 is used to implement automation scripts using visual programming.

The BIM-based tool is implemented using the following components.

1. Work Zones Leveling with Revit:
 - a. Listing of BIM parameters to implement leveling process.
 - b. Development of template view with filters based on BIM parameters.
 - c. Development of quantity takeoff schedules to balance labor hours in each work zone after defining the work zone layout.
2. Formwork BIM modeling with Revit and Dynamo:

A set of tools designed in Dynamo for Revit are developed for automating: (1) the auditing process of an existing BIM model, (2) modeling formwork considering practitioners' preferences regarding LOD, and (3) populating data necessary in the BIM model for formwork management.

3. Formwork Management with Revit and Dynamo:

A set of tools designed in Dynamo for Revit are developed for automating: (1) the computation of computing of formwork quantities, (2) defining the formwork demand, (3) preparing a formwork cost analysis, (4) computing formwork KPIs, and creating 4D and 5D simulations.

1.6. Research Methodology

Lean principles and BIM tools are used to address the gaps found in the literature review related to work zone leveling and formwork management. There are six phases in the research methodology.

1. Review of the state of the art and state of practice. A survey instrument was developed, tested, and then deployed to AEC practitioners (contractors, BIM specialists and consultants, formwork experts (manufacturers, providers, renting companies), and academics to determine common practices and preferences related to BIM modeling for formwork management, BIM automation, and formwork renting options.
2. BIM modeling. A BIM-based tool using Revit is developed for modeling building structural elements considering practitioners' preferences based on survey results. A list of BIM shared parameters is also created to enhance work zone leveling and formwork analysis. Multiple Dynamo Scripts are implemented to automate various processes for BIM modeling.
3. Development of work zones layout. A BIM process using Lean principles (*create flow* and *establish pull*) is then developed to facilitate the implementation of this BIM based tool for planning of projects.

4. Formwork management. A BIM-based tool using Revit and Navisworks is created for performing a cost analysis that considers the average total cost for a building project. Multiple Dynamo Scripts are implemented to automate various processes for formwork management tasks.
5. Testing of two case studies. The BIM-based tool for formwork modeling and management is tested using examples of a 20-story building (46,650 m² high-rise office building) and a 5-story building (46,650 m² mall Structure)
6. Analysis of results. The formwork schedules, cost analyses, and KPIs like cost rate, reuse factor and formwork efficiency are compared when the BIM-based tool is applied for formwork management for the two projects (the 20-story building and the 5-story building).

Figure 1.2 shows a flowchart of the research methodology. Each column groups the process flowchart for each of the phases described previously in this section. At the bottom of each column a brief description of the expected deliverables for each phase is presented.

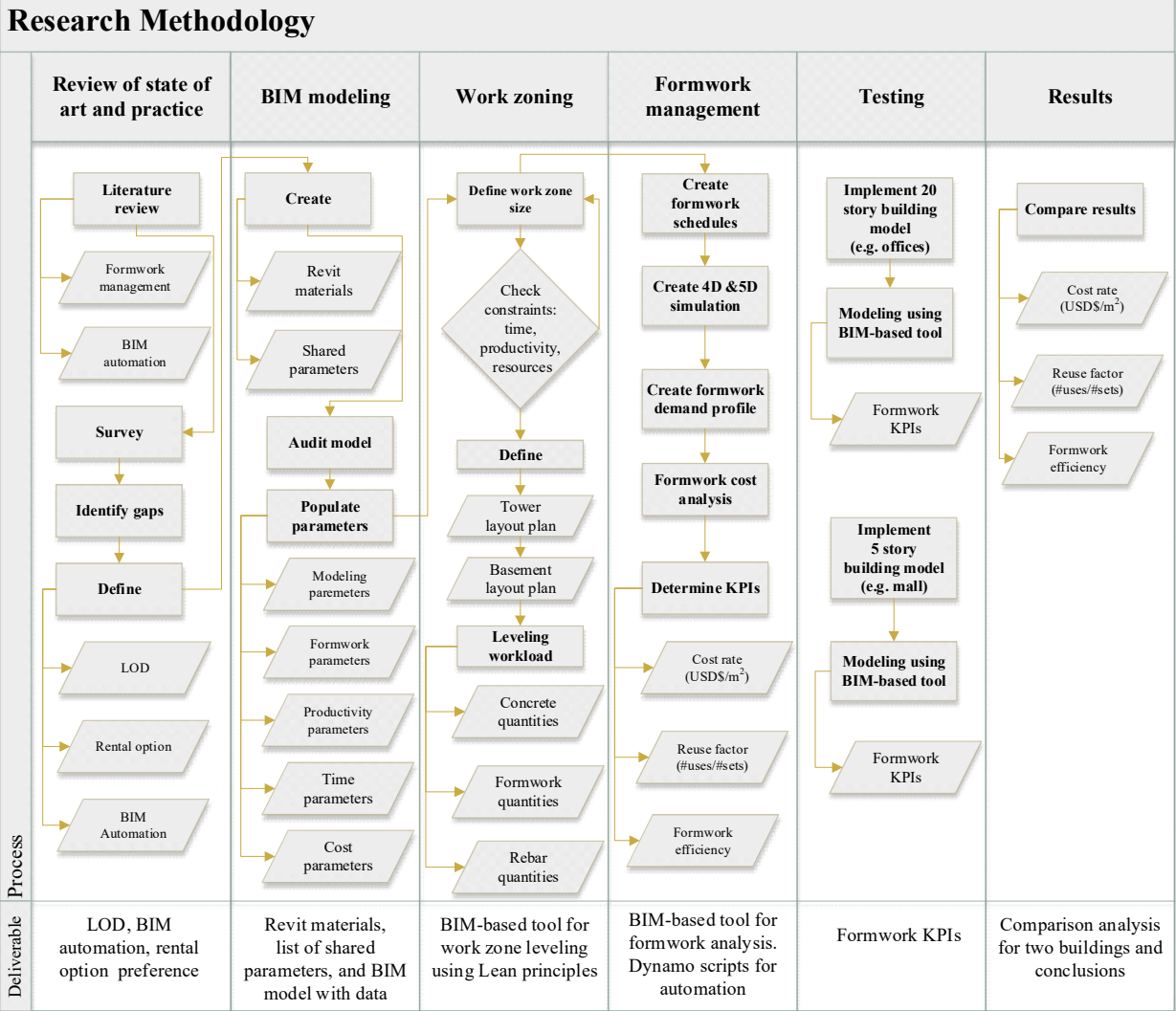


Figure 1.2. BIM Framework Methodology for formwork Management

1.7. Research Methodology

This thesis is organized into five chapters. Chapter 1 includes a brief description about the importance of formwork in building projects, the motivation for the study, followed by a short description of the research objectives of this study and a description of the research methodology. Chapter 2 presents a review of the current literature to understand the gaps in prior studies. A review of the current practice related to BIM applied to formwork management is included and the challenges in using BIM for formwork management are presented. Then, the results of a survey (deployed to the AEC community, involved in formwork activities) related to the current BIM

preferences and formwork renting options are presented. Chapter 3 provides a detailed description of the functionality of the BIM-based tool developed for automating the processes related to: (1) creating parameters and materials, (2) auditing a BIM model for formwork management, (3) formwork modeling, and (4) populating BIM parameters. Chapter 4 describes the functionality of the BIM-based tool developed for automating formwork management tasks such as: (1) computing formwork quantities takeoffs, (2) determining the formwork demand, (3) performing a formwork cost analysis, (4) computing formwork management KPIs, (5) preparing 4D and 5D simulations, and (6) creating layouts with color-coded mapping for tracking formwork. Two case studies are also presented in Chapter 4 to evaluate the BIM-based tool for formwork modeling and formwork management. The results of the KPIs obtained for both buildings are compared and analyzed. The two case studies are: (1) a 20-story building that represent a typical office building, and (2) a 5-story building that represents a mall. Both buildings have the same built area but different footprints and heights to analyze different cases of formwork analysis and work zone leveling. Chapter 5 summarizes the results obtained, the conclusion based on the analyses, the key contributions of the new BIM framework, limitations of the current work, as well as recommendations for future research.

2. REVIEW OF THE STATE OF THE ART AND STATE OF PRACTICE IN FORMWORK MANAGEMENT

This chapter provides a synthesis of prior research in formwork management. Prior research related to the use of BIM technologies to improve the efficiency of formwork is reviewed to determine: (1) the current needs of the industry for managing formwork as well as the adoption of BIM for this purpose, and (2) the gaps in the current research related to formwork modeling, planning and management using BIM. To complement the literature reviewed, a review of developments by some well-known formwork companies is conducted to understand the current use of BIM. Finally, the aggregated results of a survey deployed to a group of Architecture, Engineering, and Construction (AEC) practitioners involved with formwork management on building projects, are presented to gauge the needs about: (1) Level of Development (LOD) for BIM formwork modeling, (2) the preferences about formwork rental options, and (3) the level of automation of the current practice for formwork management processes.

2.1 Formwork management in building projects

Formwork management includes five main phases in a reinforced concrete building project (initiation, planning, execution, monitor and control, and closing). The initiation phase deals with the formwork needs on the project. The planning phase involves defining the formwork system needed, formwork supplier, most efficient formwork reuse scheme, and formwork set size required for the execution. The execution phase includes all tasks related to performing the project activities that entail formwork (procuring, erecting, stripping, handling, maintaining, and cleaning). The monitoring and control phase includes tracking the scope, cost, and time for formwork activities and accomplishing the objectives regarding these three aspects. The closing phase is the formwork demobilization based on a formwork schedule, and processing of lien release documents issued by the formwork supplier since there are multiple costs that are claimed at the end of the rental period (penalties for formwork damages, replacement of lost formwork, final cleaning, and maintenance of formwork system, and preparation for transportation). The most significant aspect of formwork management is concentrated in the planning phase and in the monitoring and control phase. The next subsections are focused on these two phases (planning, monitor and control).

2.1.1 Formwork layout planning and work zones planning

The first step in planning execution of a building project is definition of the schedule and the master planning. The master plan must have sufficient detail to specify the sequence of activities on the critical path and work zones layout since these two components are the basic elements that determine the duration of a building. The detailed process for defining the work zones and layout plans is presented next in the step-by-step map, shown in Figure 2.1.
















DEFINE LAYOUT PLANNING AND WORK ZONES PLANNING					
	Schedule	Work zones size	Main floor plans	Layout floor plans	Work zones leveling
Input	Duration objective 	№ of work zones 	Building floor plans 	Tower main plan Basement main plan Building main plan 	Work zone layouts 
Process	Determine project schedule  $\text{Duration} = \text{№ Work zones} + \text{cycle time}$	Check work zones size & № of production sets 	Define main floor plans 	Define construction joints & work zones 	Work load leveling 
Output	№ of work zones 	№ of production sets 	Tower main plan Basement main plan Building main plan 	Work zone layouts 	Optimal work zone layout & minimum variability 

Figure 2.1. Formwork layout and work zones planning.

Define project schedule for accomplishing the duration objective.

The first step for defining the schedule of a building project is to understand the client’s objectives related to cost, time, and scope. These client’s objectives will define the “takt time” of building. The “takt time” is the maximum time available to meet the client’s demand and can be estimated using Equation 2.1. Considering an example of a 10-story building, if the client requires the RC

framing of the building to be completed in 65 working days then applying Equation 2.1 the “takt time” for a single story of the building will be equal to 6.5 days/story.

$$Takt\ time = \frac{Production\ time\ available}{Required\ units\ of\ production\ (client\ demand)} \quad (2.1)$$

$$Takt\ time = \frac{65\ days}{10\ stories} = 6.5\ days/story$$

According to the “theory of constraints” of (Goldratt, 2014), a production system should be subordinated and synchronized to the process constraint (bottleneck activity). Based on criterion, in a linear scheduling like the case of high-rise buildings, all the activities should be synchronized to the same “cycle time”. The “cycle time” is the actual time a product is in process. Since “cycle time” only considers the time the product is in progress (net production time), then it must be lesser than the “takt time”. Equation 2.2 shows the mathematical expression of the “cycle time.” In the case of the 10-story building, the maximum “cycle time” for every story of the building will be 6 days/story. Hence, the floor “cycle time” will be 6 days/story since we are considering full days in a construction schedule.

$$Cycle\ time = \frac{Net\ production\ time}{Number\ of\ units\ produced} < Takt\ time \quad (2.2)$$

The third Lean metric is the “lead time”, which is the time considered since the first production process starts until the product is finished. The difference between the “lead time” and the “cycle time” is the “total lag time” between activities. The “lead time” is represented by Equation 2.3.

$$Lead\ time = Cycle\ time + Total\ lag\ time \quad (2.3)$$

In the example of the 10-story building, the “cycle time” and the “lead time” are graphically represented in the lookahead schedule (without considering weekends and holidays) in Figure 2.2 for the first work zone and for the first story of the building. The “lead time” for a work zone in the lookahead schedule represented in Figure 2.2 is 6 days (cycle time of 1 day + total lag time of 5 days). Similarly, the “lead time” for a story in 10-story building is 11 days (cycle time of 6 days + total lag time of 5 days) shown in Figure 2.2.

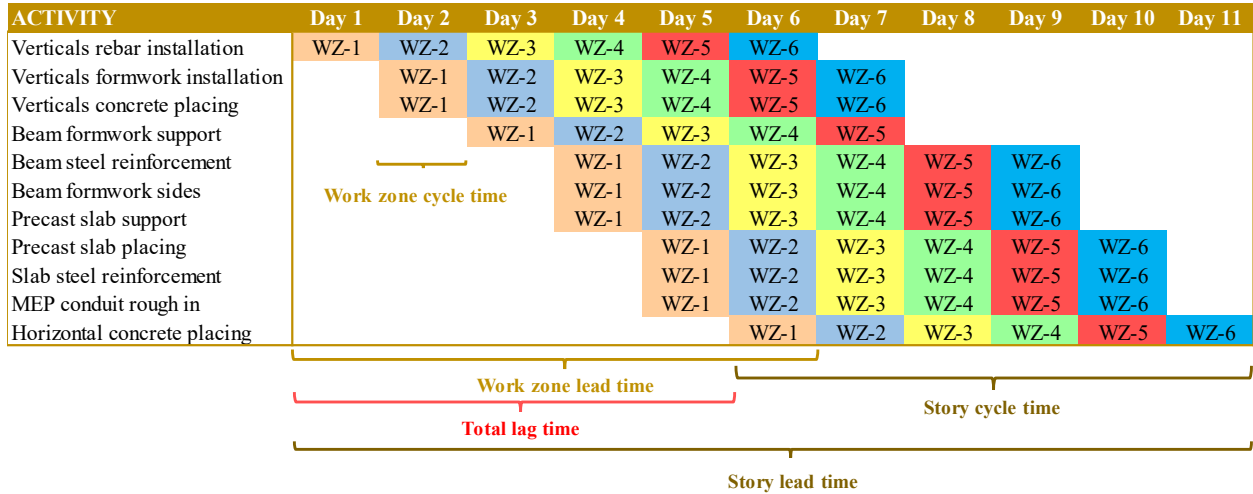


Figure 2.2. Lookahead schedule for 1st story of 10-story building

Since each story has 6 work zones (because of the cycle time selected) the total number of work zones in the building will be 60 work zones (for the 10-story building). The duration of the RC framing structure of building is defined by Equation 2.4 and is 65 days (total lag time of 5 days + cycle time of 1 day/work zone multiply by the 60 work zones)

$$Duration = Total\ lag\ time + Work\ zone\ cycle\ time \times Number\ of\ work\ zones \quad (2.4)$$

Figure 2.3 shows the lookahead schedule of the last story (level 10), and Figure 2.4 show the relationship between the program chart and the objective chart of the 10-story building example. Figure 2.3 shows the activities of the day 60 in the lookahead, and Figure 2.4 shows the activities graphically represented in a 3D view of the building. Each work zone is represented with a different color, showing the activities executed each day on each work zone and each level. The lead time for the first story (11 days) is also shown on the program chart (for a story) and the objective chart (red arrow) in Figure 2.4. The total duration of the building (65 days) is represented in the lookahead schedule of Figure 2.3 and the objective chart of Figure 2.4.

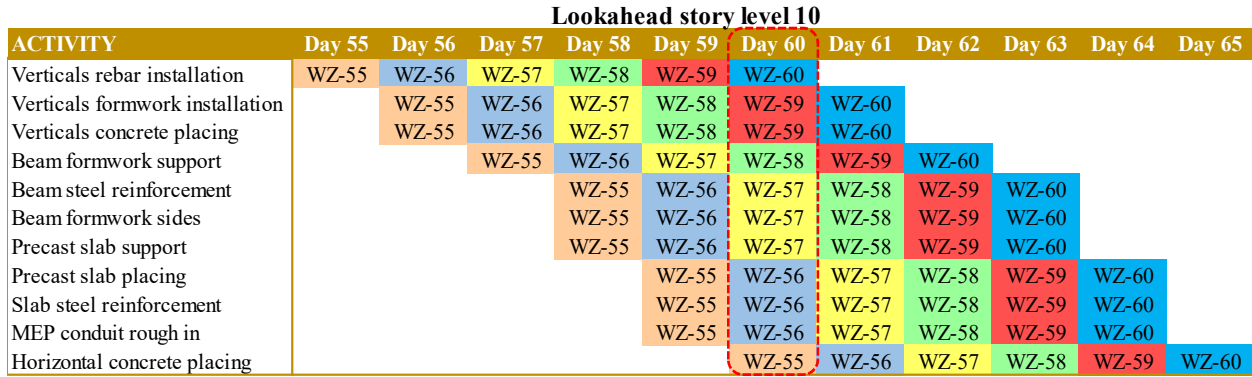


Figure 2.3. Lookahead for 10-story building

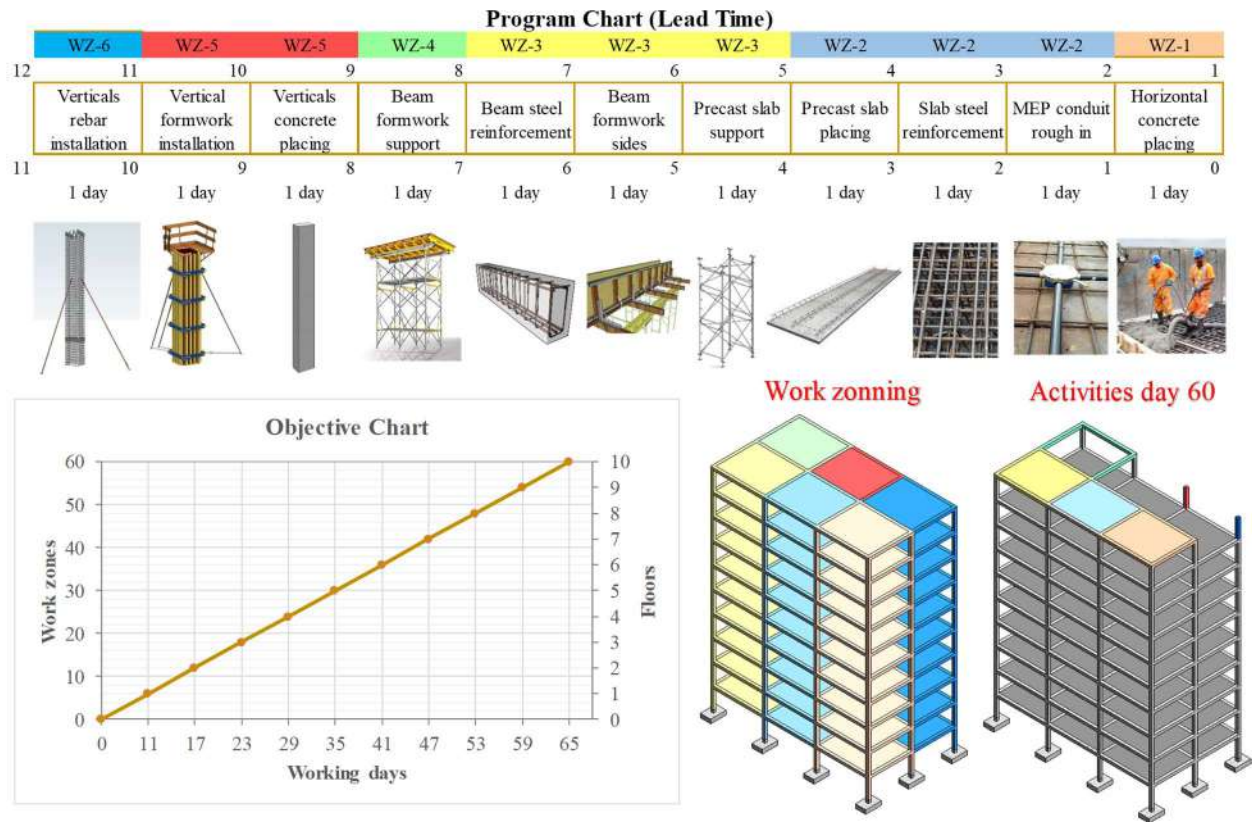


Figure 2.4. Program chart and objective chart for 10-story building

Verify work zones size and number of productions sets.

Once the number of work zones required to reach the duration objective is determined, there are two main verification steps that are undertaken. The first verification step is the determination of the size of each work zone which is directly related to the “concrete placement rate”, defined as

the volume of concrete that the “production team” can place each working day considering project constraints (easy access of concrete mixers, equipment used for placing concrete, frequency of concrete delivery, lateral pressure capacity of forms, etc.). For example, if the production team uses a concrete pump, and the frequency of concrete delivery is 28 m³/hour over an 8-hour shift, then the daily concrete placement rate will be between 100 to 150 m³ to cover 200 or 250 m² of building area.

The second verification step involves checking the number of “production teams” or “production sets”. A “production set” is the group of resources necessary for producing the daily work. A production set in a building project is composed of the crews of each trade and the equipment allocated to these crews (crane, concrete pump, fleet of mixers, etc.). The definition of the number of production sets will affect the schedule and budget of a project, such leading to a tradeoff between the time and cost objectives. Typically, time will overrule in this tradeoff since reduction of time will be associated with reduction in overhead costs and rental costs. Since each “production set” should have an independent set of resources, to ensure the production flow, each production set should be able to build the work zone size defined in the previous step (200 to 250 m² of building area).

Define building main floor plans.

The “work zoning” process starts identifying the typical floor plans for the. High-rise buildings typically have a one layout for the floor plans underground and another layout for the above ground floor plans. For example, Figure 2.5 shows a building where all the floor plans underground have a similar area, distribution of elements, and probably similar quantities of work. Similarly, Figure 2.5 shows that the floor plans of the tower are the same or might be slightly different. In the case of the example shown in Figure 2.5, there are two different layout floor plans: one that represents all the stories underground, and another that represents all the stories above ground. In other high-rise buildings there may be different floor plans, depending on the variability of the shapes, areas, and distribution of vertical elements (columns and walls) between different stories.

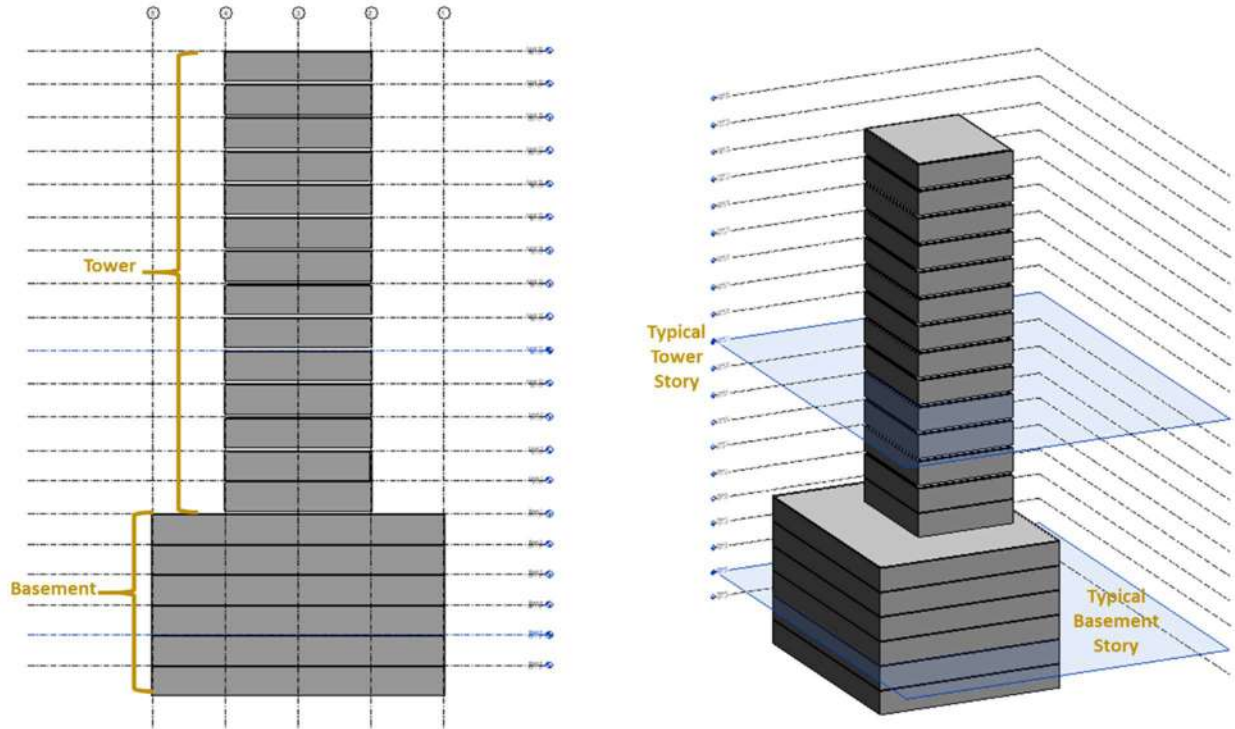


Figure 2.5. Elevation view and 3D view of typical parts and stories of a building to define main layout plans.

Define the main layout floor plan of the building.

In the previous step, the main floor plans of the building were identified. For the example shown (see Figure 2.5) the building only has two main floor plans (one for the tower and one for the basement). Once the main floor plans are identified the next step is to select which plan will be the “main layout floor plan”, that will be used to “trace” the boundaries of the work zones, and to project these imaginary lines (boundaries of work zones) to the rest of floor plans. These work zone boundaries will be the “construction joints” in the horizontal elements (slabs and beams) during concrete placement for floors. For the example shown in Figure 2.5, the “main layout floor plan” of the building will be the “main floor plan” of the tower (above ground portion of the building), because is representative of the floor plans of all/majority of the floors in the building.

Layout floor plans and work zones leveling

Ideally the work zones should have similar amount of work, both in term of work zone balance, and in terms of labor requirements. The algorithm for optimizing the work zones leveling can be described as shown in Equation 2.5.

$$\min_{i,j}(\delta_C + \delta_F + \delta_R) \quad (2.5)$$

Where:

" δ_C " is the variation of labor hours between two consecutive work zones for the concrete trade

" δ_F " is the variation of labor hours between two consecutive work zones for the formwork trade

" δ_R " is the variation of labor hours between two consecutive work zones for the rebar trade

$$\delta_C = \sum_{j=2}^m \left(\sum_{i=1}^n (QTO_{C_{ij}} \cdot P_C) - \sum_{i=1}^n (QTO_{C_{i,j-1}} \cdot P_C) \right) \quad (2.6)$$

$$\delta_F = \sum_{j=2}^m \left(\sum_{i=1}^n (QTO_{F_{ij}} \cdot P_F) - \sum_{i=1}^n (QTO_{F_{i,j-1}} \cdot P_F) \right) \quad (2.7)$$

$$\delta_R = \sum_{j=2}^m \left(\sum_{i=1}^n (QTO_{R_{ij}} \cdot \rho \cdot P_R) - \sum_{i=1}^n (QTO_{R_{i,j-1}} \cdot \rho \cdot P_R) \right) \quad (2.8)$$

Subject to:

H_1 : $QTO_{C_{ij}}$ = Concrete volume of element type "i" in work zone "j"

H_2 : $QTO_{F_{ij}}$ = Formwork contact area of element type "i" in work zone "j"

H_3 : $\sum_{j=1}^m (QTO_{C_j})$ = Total cast in place concrete volume in the entire building

H_4 : $\sum_{j=1}^m (QTO_{F_j})$ = Total contact area of formwork in the entire building

H_5 : Columns, Shear walls cannot be split

H_6 : Construction joints for horizontal elements within middle third of span

Where:

$QTO_{C_{ij}}$ = Concrete volume of element type "i" of work zone "j" (m^3)

$QTO_{F_{ij}}$ = Formwork contact area of element type "i" of work zone "j" (m^2)

P_C = Labor productivity for concrete placing (labor hours/ m^3)

P_F = Labor productivity for formwork erection (labor hours/ m^2)

P_R = Labor productivity for rebar preparation and installation (labor hours/kg)

ρ_i = Reinforcement ratio of element type "i" (kg/ m^3)

For the “labor productivity” values (P_C , P_F , P_R) ideally each contractor would use historical data from previous projects. An example of these values based on multiple building projects (data from 34 RC buildings in Peru) are shown in Table 2.1. The buildings shown in the Table 2.1 are RC mixed structures of columns, shear walls, beams, and flat slabs.

Table 2.1. Labor productivity values

Description	Unit	Office	Education	Hospitality	Housing	Overall
		LH/unit	LH/unit	LH/unit	LH/unit	LH/unit
Concrete	m ³	1.40	1.73	1.55	1.44	1.45
Formwork	m ²	1.56	1.68	1.65	1.60	1.61
Rebar	Kg	0.044	0.048	0.044	0.049	0.045

A practical way to estimate the quantity of work in each work zone based on the area is using ratios of concrete, formwork, and rebar quantities. An example of these ratios based on multiple building projects are shown in Table 2.2 but there are several references for obtaining these values (including historical data, or RS Means).

Table 2.2. QTO ratios per square construction area.

DESCRIPTION	AVERAGE RATIOS PER M ²		
	m ³ /m ²	m ² /m ²	Kg/m ²
	CONCRETE	FORMWORK	REBAR
Foundations	0.03	0.02	1.55
Vertical Elements	0.10	0.56	17.99
Horizontal Elements	0.20	1.03	29.47
Total	0.33	1.62	49.01
Steel reinforcement ratio:	Rebar/concrete	kg/m ³	149.93

2.1.2 Formwork systems

A formwork system is the assembly of components that together are designed for forming or shoring a specific concrete element newly placed. The omission of one component of the formwork system during the assembly may cause an unsafety condition or even an accident, since the design of these systems is only guaranteed if all the components are working together. There are two groups of formwork systems: (1) modular prefabricated formwork systems, and (2) jobsite-built formwork systems. The use of modular prefabricated formwork systems is gaining momentum in construction, and conventional methods like using jobsite-built formworks are becoming less

popular in the industry. Typically, modular prefabricated formwork is made of materials with better durability for several uses, and prefabricated formwork manufacturers provide their customers with technical, logistic, and training support. In contrast, job-site formwork is prepared with materials that fewer number of uses, and all the design, logistics and training is entirely the responsibility of the contractor. Typically prefabricated modular formwork is rented by contractors. Modular formwork is available in standard sizes, and the use of a specific formwork system will depend on the features of the building project (shapes, dimensions, lateral form pressure, etc.). Also, renting prefabricated modular formwork instead of owning it, provides of other advantages like: (1) low initial investment, (2) low risk of the investment in case of fluctuation in the market, (3) capacity to reduce or increase the demand of equipment at any time of the project, and (4) capacity to obtain the latest technology. Figure 2.6 shows a map of the most common formwork systems available for building projects.

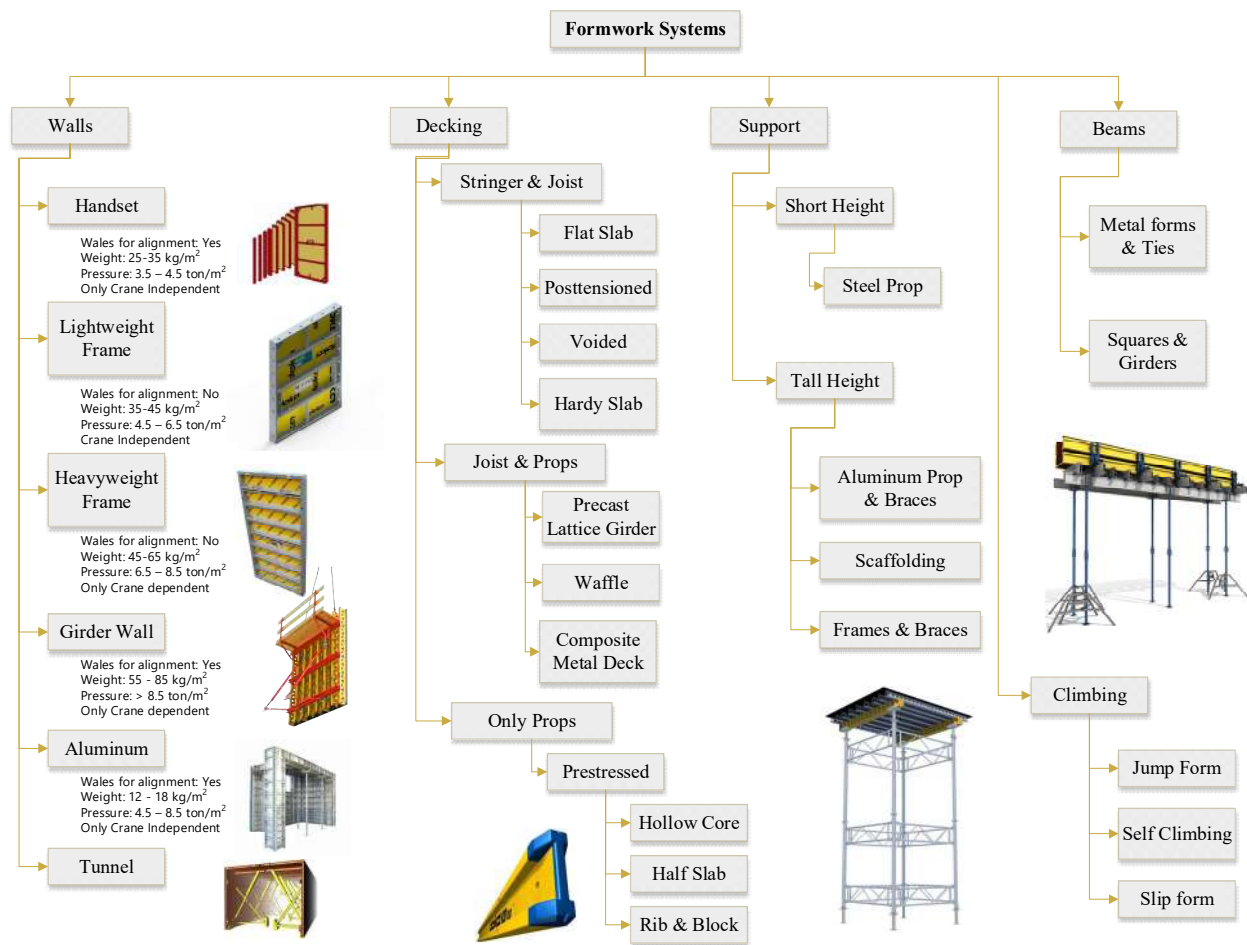


Figure 2.6. Formwork Systems Map. Adapted from (Jimenez, 2020)

From the perspective of the concrete contractor perspective who self-performs formwork installation and considers renting formwork, the Request for Proposal (RFP) for selection of formwork provider must consider technical specifications (lateral form pressure, headroom height, working loads, concrete placement rate, etc.), and specific instructions to bidder about formwork system scope. When doing a comparative analysis of proposals, the concrete contractor should verify that all bids from bidders (in this case, formwork providers) are comparable, i.e., all proposals must consider the same technical specifications, and similar/same complementary accessories required for the project (crane accessories, railings, ladders, access gates, platforms, hauling systems, etc.)

If technical proposals across formwork providers are similar, then factors such as cost, productivity, and surface grade quality may be used to determine the low bidder though the “equivalent lump sum” method. Generally, contractors are more cost conscious and will use a “cost analysis” to compare options but there are techniques like “Choosing by Advantages” (CBA), “Analytical Hierarchical Process” (AHP), and “Linear Scoring” that are able to consider multiple criteria even when criteria are not easy to express in terms of cost.

2.1.3 Formwork rental options.

In the building industry there are two primary rental options for formwork systems: (1) renting by pieces or components of the system for a specific duration (commonly in \$/piece-month), and (2) renting by solution for a specific use and for a specific duration (commonly expressed in \$/m²-month). The second option is more popular specially during the bidding process since it is easier to estimate areas rather than a specific number of formwork pieces/components. Also, doing the comparison between bids is easier if all proposals use the same measurement unit (m² or m), since formwork suppliers may have different components in their formwork systems. In addition, all bidders should incorporate safety components like working decks and railings, as well as the accessories required for handling by the cranes or forklifts. Figure 2.7 shows the most common formwork solutions used in building projects. Formwork bidders commonly present their proposals as unit prices for each system (as shown in Table 2.3).

Table 2.3. Typical formwork bid proposal.

Description of Solution	Unit.	Unit Price (\$/month)	System
Columns			
Formwork Column $h < 3.60\text{m}$	m^2		
Formwork Column $3.60 < h < 6.70\text{m}$	m^2		
Formwork Column $h > 6.70\text{m}$	m^2		
Formwork Column circular	m^2		
Walls			
Formwork Wall $h < 3.60\text{m}$	m^2		
Formwork Wall $3.60 < h < 6.70\text{m}$	m^2		
Formwork Wall $h > 6.70\text{m}$	m^2		
Beams			
Beam shoring $h < 3.60\text{m}$	ml		
Beam shoring $3.60 < h < 6.70\text{m}$	ml		
Beam shoring $h > 6.70\text{m}$	ml		
Beam sides, Depth $P < 0.40\text{m}$	m^2		
Beam sides, Depth $0.40 < P < 0.70\text{m}$	m^2		
Beam sides, Depth $0.70 < P < 1.00\text{m}$	m^2		
Beam sides, Depth $P > 1.00\text{m}$	m^2		
Beam bottom (metal)	m^2		
Beam bottom (plywood)	m^2		
Slabs			
Slab shoring $h < 3.60\text{ m.}$	m^2		
Slab shoring $h = 3.60 < h < 6.70\text{ m.}$	m^2		
Slab shoring $= 3.60 < h < 6.70\text{ m.}$	m^2		
Slab shoring $h > 6.70\text{ m.}$	m^2		

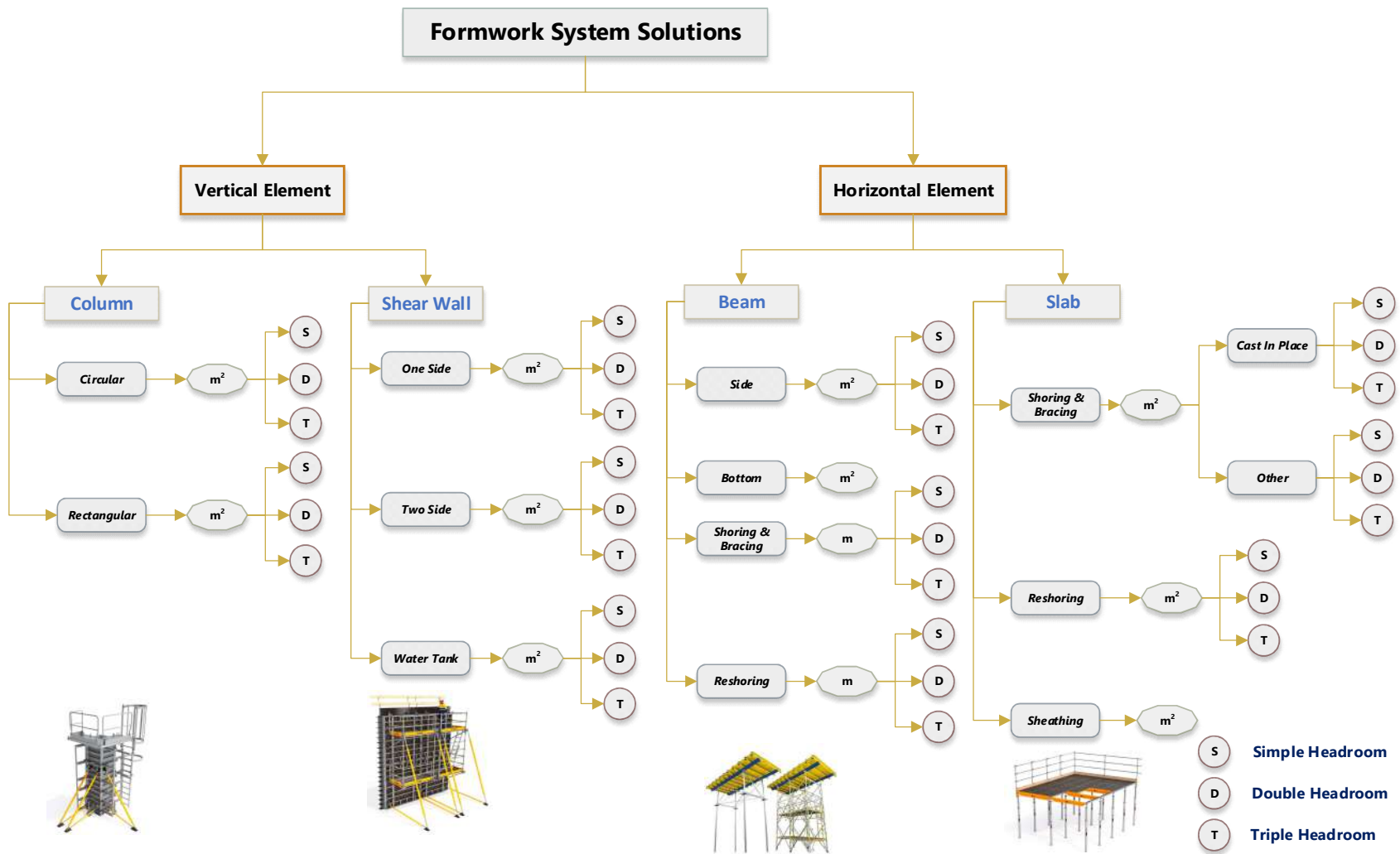


Figure 2.7. Formwork rental options map.

2.1.4 Formwork demand profile

Since work zones have different quantities of forming contact area, an ideal “contact area profile” or “Formwork Used” profile (FU) could be plotted as shown in Figure 2.8. “Formwork used” (FU) profile represents the sum of contact area of the formwork required for performing three phases: (1) forming or shoring a new work zone, (2) holding concrete of a work zone newly placed, and (3) holding concrete of all the previous work zones while concrete gains adequate compressive strength to self-support its own weight and the construction loads.

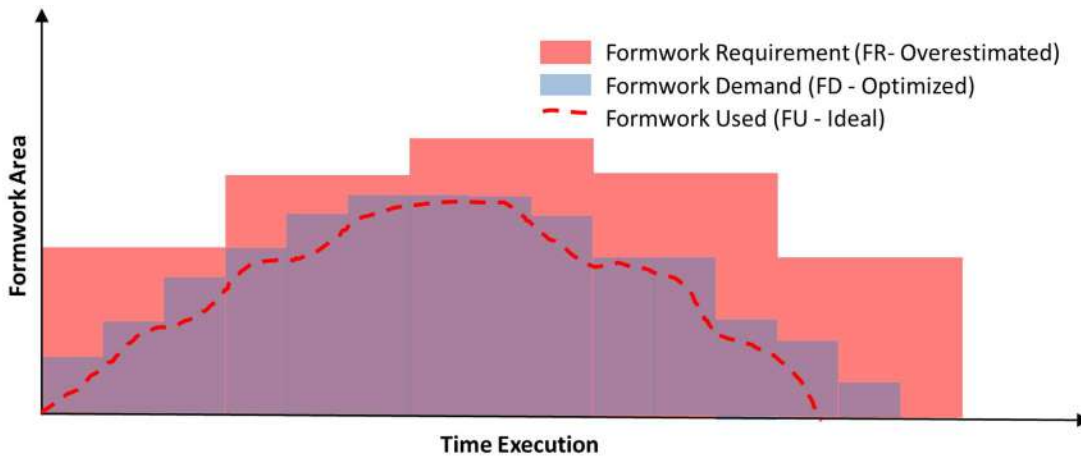


Figure 2.8. Formwork demand profiles

The number of formwork sets will depend on how many days each formwork phase will take (assembly, holding concrete newly placed, and holding concrete until it is able to self-support). Equation 2.9 shows how the total number of formwork sets can be determined. FU is the total contact area covered by all formwork sets on the project. Since work zones have different formwork contact areas, the profile will increase until the “maximum formwork set size” is reached, and then the profile will remain uniform until the concrete placement schedule is completed. The profile will decrease during the formwork demobilization schedule.

$$N^{\circ} \text{ of formwork sets} = T1 + T2 + T3 \quad (2.9)$$

Where:

T1: Days required for disassembling a formwork set and reusing it for assembling a new work zone.

T2: Days required for placing concrete in a new work zone.

T3: Days required for supporting a work zone until concrete is self-supported.

Typically, formwork companies typically rent out their formwork systems for a minimum period of one month. The “Formwork Demand” (FD) profile (shown in Figure 2.8) represents the formwork needed on the job, with the realization it is not economically feasible to return to the formwork contractor, demobilized formwork that may be used again on the same job. The third profile represented in Figure 2.8 is the “Formwork Requirement” (FR) which is represented by a red shaded histogram. The FR profile is greater than the FD profile since contractors always consider additional formwork elements/formwork systems to account for contingencies. Overestimating FR will generate problems such as: (1) additional costs for renting formwork that may not be used, and (2) additional costs for penalties if the surplus formwork is damaged or lost. Figure 2.9 and Figure 2.10 show typical misuses of formwork. In the Figure 2.9, the form is used as a platform and in Figure 2.10, the surplus forms are partially buried during the placement of the foundation.



Figure 2.9. Formwork element used as a work platform



Figure 2.10. Surplus formwork partially buried on site

2.1.5 Cost analysis of formwork

A formwork cost analysis is the estimation of all the cost components that must be considered by decision makers when selecting a formwork system based on cost. The cost components to be considered in the formwork cost analysis can be grouped into labor, materials, and subcontracts. Labor cost is the first cost component that might be directly affected by the selection of a formwork system. Since each formwork system can have different features for the assembly, reuse, and disassembly, productivity related to formwork installation will be affected. A formwork system with fewer pieces is often linked with better productivity. For example, a handset formwork typically requires disassembly after each use, unlike a gang formwork which can be used

repeatedly once it has been assembled. Equation 2.10 shows the mathematical expression for estimating the labor cost.

$$\text{Labor cost}(\$) = \text{Productivity} (\text{hr}/\text{m}^2) \times \text{Labor rate}(\$/\text{hr}) \times \text{Contact area} (\text{m}^2) \quad (2.10)$$

The next cost component is the materials cost used for forming. Materials that might differ depending on the formwork solution selected are: (1) timber for complementary items (chamfers, block outs, grade strips, reveals, etc.), (2) plywood for sheathing, and (3) accessories or consumables. Other items such as nails and screws are likely to be very similar across different formwork solution systems, so they are not considered in cost analysis. The subcontracts' cost component may include: (1) the formwork system rental cost, (2) the provider fees for maintenance and cleaning, (3) provider penalties for damaged or lost formwork components, and (4) the freight required for transporting formwork systems to the jobsite and returning them to the provider's warehouse at the end of the project. Equation 2.11 consolidates all the cost components:

$$\text{Formwork Baseline Cost} = C_1 + C_2 + C_3 + C_4 + C_5 + C_6 + C_7 \quad (2.11)$$

Where:

C_1 = Formwork rental cost

C_2 = Formwork consumables cost

C_3 = Timber cost

C_4 = Plywood cost

C_5 = Formwork maintenance and cleaning cost

C_6 = Penalties for lost or damaged formwork components

C_7 = Freight cost

Figure 2.11 shows a “cause effect diagram” to analyze why formwork budgets in building projects may experience additional costs. Each branch represents a cost component in formwork cost analysis. “Surplus formwork” on the jobsite and the “poor work zone leveling”, are root causes for additional costs in formwork budgets.

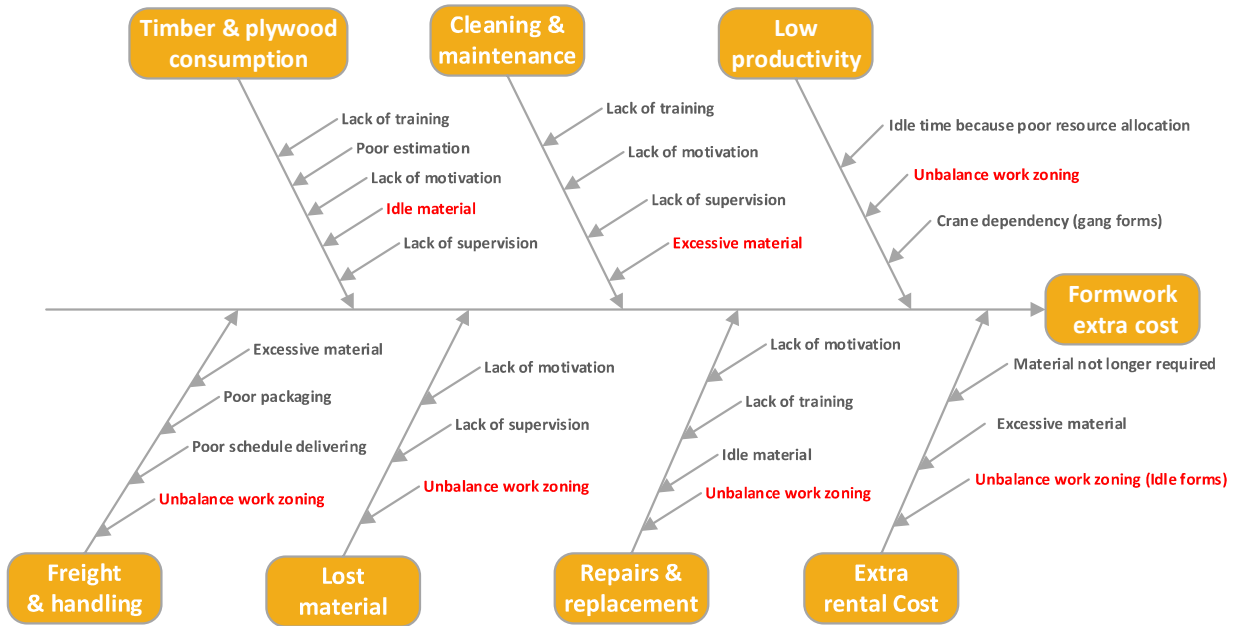


Figure 2.11. Cause effect of formwork extra cost

2.1.6 Formwork control with KPIs

A “Key Performance Indicator” (KPI) for formwork management is a measurable value that demonstrates the effectiveness of the use of formwork systems on a project. The key performance indices used for formwork management include the “Cost Ratio” (CR), the “Reuse Factor” (RF), and the “Formwork Efficiency” (FE).

As shown in Equation 2.12, the cost ratio (CR) is the ratio of the total formwork cost (\$) to the total contact area that needs forming or shoring expressed in terms of square meters. This unit cost can be used to compare different formwork solution systems for bid proposals submitted for a single project or even across different projects.

$$CostRatio(CR) = \frac{Total\ formwork\ cost(\$)}{Total\ formwork\ contact\ area(m^2)} \quad (2.12)$$

The “Reuse Factor” (RF) is the ratio of the number of uses of a formwork set (which is generally equal to the number of work zones) to the number of formwork sets. Since vertical elements (columns and walls) and horizontal elements (slabs and beams) have different number of formwork sets, the reuse factor must be computed separately for each type of formwork. Equation 2.13 shows the mathematical expression for computing the “Reuse Factor”.

$$\text{Reuse Factor (RF)} = \frac{\text{Number of work zones}}{\text{Number of formwork sets}} \quad (2.13)$$

The “Formwork Efficiency” (FE) KPI is the ratio of the total formwork contact area of the building project to the total contact area covered by the formwork sets. This KPI in comparison with the “Reuse Factor” (RF) considers the reuse component for vertical elements and horizontal elements since it uses the area of both element types as the common unit. The interpretation of this KPI is as follows: “each square meter of a formwork set can be used for forming or shoring “FE” square meters”. Equation 2.14 shows the mathematical expression for computing the “Formwork Efficiency”.

$$\text{Formwork Efficiency (FE)} = \frac{\text{Total formwork contact area (m}^2\text{)}}{\text{Sets' total contact area (m}^2\text{)}} \quad (2.14)$$

Figure 2.12 shows an example of the use of CR and RF in reinforced concrete building in Peru. Histograms of different projects associated with different building uses, and the bars representing the “reuse factor” and “cost ratio” for each building project are shown in this figure. The “reuse factor” considers only the horizontal elements and the “cost ratio” only considers the rental cost. Having multiple KPIs provides a more complete picture of the formwork performance metrics for project control and decision making. Projects with higher “reuse factor” (RF) are likely to have lower “cost ratios” (CR), but as Figure 2.12 shows this is not always true. For example, malls (labeled as RETAIL in Figure 2.12) have greater CRs than housing projects (labeled as HOUS in Figure 2.12), no matter if the RF of malls is greater (bar in red) or lower (bar in green) than the RF for housing projects (bar in blue). The formwork systems for malls have a higher rental cost since shoring with higher headroom heights (as is the case of malls) are more expensive than short headroom heights (like the case of housing projects).

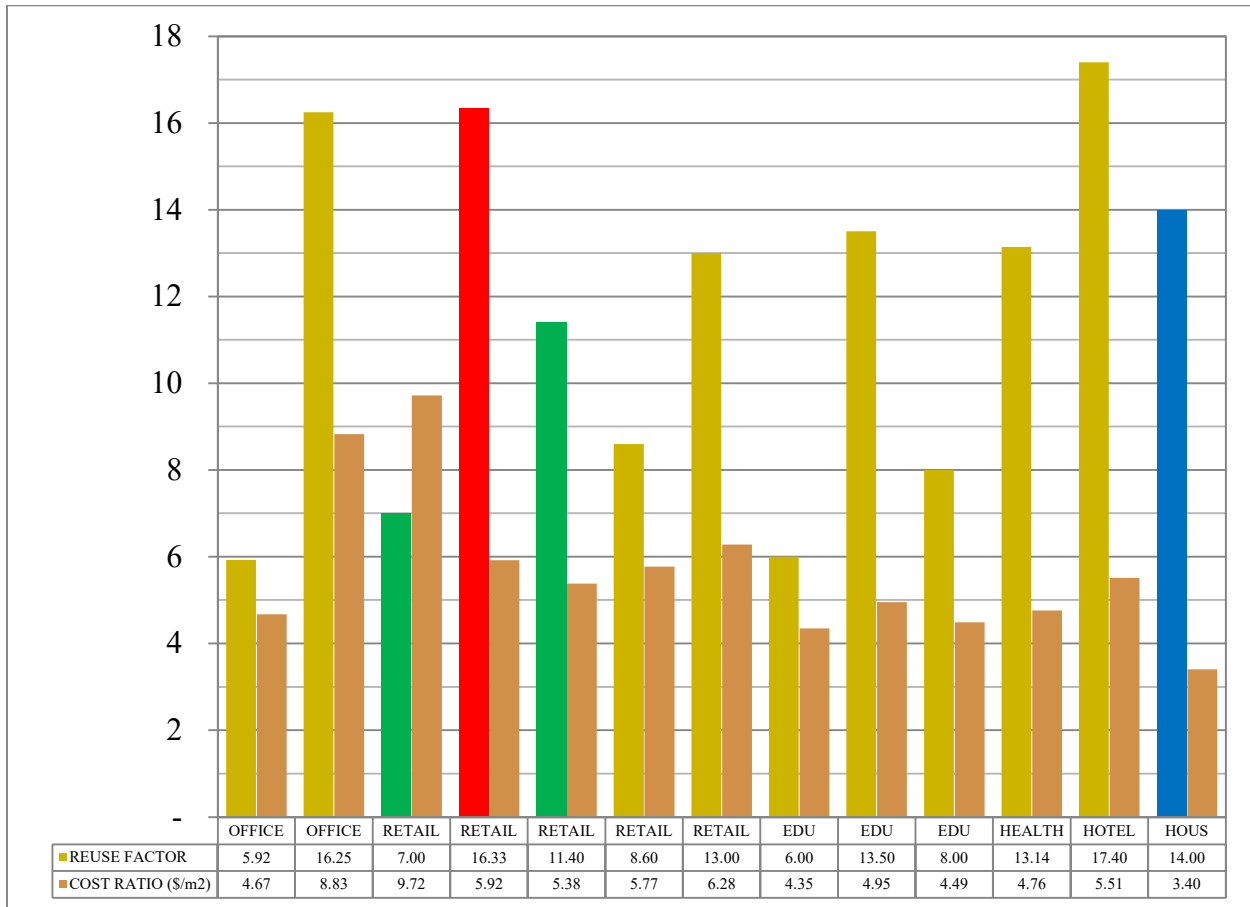


Figure 2.12. Formwork management KPIs for building projects

2.2 Previous research studies related to formwork management.

Previous research related to formwork has addressed different topics such as: (1) formwork design, (2) formwork inventory management, (3) formwork layout planning, (4) formwork selection, (5) formwork productivity, and (6) formwork safety. Table 2.4 lists several references related to these topics, and the tools used for implementing these studies. A review of this table indicates that BIM has been used as a common tool in formwork related research, and that most studies in this domain focus primarily on specific formwork elements (vertical or horizontal element) or specific formwork systems (climbing formwork, handset), and do not integrate different formwork systems of a project. This thesis focuses on addressing these gaps, developing a tool that considers horizontal and vertical formwork systems of a building project, and is applicable for climbing, gang and handset formwork systems.

Table 2.4. Previous research studies related to formworks.

Topics	Tools	Element	Formwork System	References	
Formwork Design	BIM	Vertical elements	Modular handset	(Singh, Sawhney, & Sharma, 2017)	
			Timber formwork	(Romanovskya, Mejia, & Azar, 2019)	
		Horizontal elements		(Hyun, Jin, Shen, & Kim, 2018)	
	Computer-Aided tool	NA	NA	(Gambatese & Jin, 2019)	
Formwork Inventory Management	BIM	NA	NA	(Tah & Price, 1991)	
	Cost analysis	NA	NA	(Mansuri, Chakraborty, Elzarka, & Deshpande, 2017)	
Formwork Layout Planning	BIM	NA	NA	(Krajinak,, 2013)	
	CAD	Horizontal elements	Flexible Table Form	(Kannan.Ma & Santhi.Ma, 2013)	
	Mixed Integer LP	Vertical elements	Modular Handset	(Lee, Lee, & Ham, 2009)	
Formwork Selection	Adaboost Algorithm	NA	NA	(Shin, 2011)	
	BIM			(Shin, Kim, Yang, Cho, & Kang, 2008)	
	Boosted Decision Tree			(Meadati, Irizarry, & Aknoukh, 2011)	
	CYCLONE	Vertical elements	Gang Formwork	(Shin Y. , Kim, Cho, & Kang, 2012)	
	Fuzzy Logic	Horizontal elements	NA	(Kersting & Girmscheid, 2011)	
		Vertical elements	Modular Handset	(Huang, Chen, & Sun, 2004)	
	Computer-Aided tool	Horizontal elements	NA	NA	(Elbeltagi, Hosny , Elhakeem, Abd-Elrazek, & Abdullah , 2011)
		Vertical elements			(Razek, 1999)
	Neural Networks	NA	NA	NA	(Elbeltagi E. , Hosny, Elhakeem, Abdelrazek, & El-Abbasy, 2012)
					Horizontal elements
Vertical elements					(Hanna, Willenbrock, & Sanvido, 1992)
Practitioners' experience	NA	Timber formwork	NA	(Elazouni, Ali, & Abdel-Razek, 2005)	
Productivity	BIM	NA	NA	(Tam, Tong, Lau, & Chan, 2005)	
		Vertical elements	Climbing Formwork	(Hanna & Senouci, 1995)	
	Constructability	NA	NA	(Kamarthi, Sanvido, & Kumara, 1992)	
	Lean (VSM)	Vertical elements	Timber formwork	(Proverbs, Holt, & Olomolaiye, 1999)	
Safety	BIM	NA	NA	(Kim & Ahn, 2011)	
			Railings	(Zhang, et al., 2015)	
				(Zhang, Lee, Venugopal, Teizer, & Eastman, 2011)	
			Scaffolding	(Kim, Cho, & Kim, 2018)	
				Stairs	(Chi, Hampson, & Biggs, 2012)
			(Kim & Cho, 2015)		

Before the advent of BIM tools in the AEC industry, formwork management was based primarily on contractor experience, and the process for designing, modeling, planning, and scheduling was a time-consuming manual process. The rising use of BIM, has addressed some of the limitations of using 2D drawings, leading to better opportunities for improving formwork management. Multiple research studies have used BIM to improve formwork design, modeling, and planning (Biruk & Jaskowski, 2016). In previous research related to formwork design (i.e., (Tah & Price, 1991), (Singh, Sawhney, & Sharma, 2017), (Gambatese & Jin, 2019)), BIM families or CAD drawings were used for the automation of modeling formwork components of RC walls or flat slabs separately, but not for all the formwork systems in a building. Formwork selection is probably the most extensive topic analyzed in prior research, and studies (i.e., (Hanna & Sanvido, 1991), (Tam, Tong, Lau, & Chan, 2005), (Shin Y. , Kim, Cho, & Kang, 2012), (Elbeltagi E. , Hosny, Elhakeem, Abdelrazek, & El-Abbasy, 2012)) have focused on the use of CAD tools and methods such as neural networks, decision trees or fuzzy logic to develop decision-making methods for selecting formwork. On the contrary BIM has been used for studying formwork productivity, formwork safety and for automating the generation of formwork layout plans (Kannan.Ma & Santhi.Ma, 2013).

From the literature review related with the use of BIM for formwork management, some challenges found in formwork management are as follows: (1) using BIM modeling for formwork management is a time-consuming process, and often BIM modeling is not completed before the concrete placement begins, and (2) in projects with design changes during construction makes it difficult to update a formwork BIM model. According to (Aslam, Baffoe-Twum, & Saleem, 2019) design changes in building projects around the world generate cost overrun between 5% and 40% of the project cost. An important contribution of BIM for formwork management is controlling formwork inventory, but with the requirement that all formwork components must be included in the BIM model before formwork installation commences. (Mansuri, Chakraborty, Elzarka, & Deshpande, 2017).

2.3 Developments in formwork management

Typically, technical support from the formwork provider involves designing the formwork system, defining the best formwork elements for that solution, preparing layout plans in 2D drawings, and based on this layout determining a packing list of elements required for the project execution. Companies like Peri and Doka currently provide BIM and CAD tools to support formwork

management and formwork inventory management. The main drawback of these tools and support services is that they are oriented to the formwork provider's business objectives and are only available for specific brands and products produced by the formwork provider (Biruk & Jaskowsk, 2016). Additionally, most contractors are not willing to use these tools for formwork management. In some cases, the object libraries in these BIM and CAD tools are not updated with the real stock of the formwork provider. In other cases, medium contractors (those having 50 to 250 employees) and small contractors (those having fewer than 50 employees) are reluctant to invest in acquiring these BIM and CAD tools and the associated support services.

According to (McGraw Hill Construction, 2014), in developed regions such as North America and Europe, 60% of contractors implement fewer than 30% of their projects using BIM. Also, in same developed areas only 23% of concrete contractors rate their BIM skills as high or very high. The use of cast-in-place concrete construction (for building projects) is more popular in developing regions such as Latin America and the Caribbean, the Middle East, and East Asia. According to (Jung & Lee, 2015) in an international study of BIM adoption, 46,3 % of practitioners from Asia and 71.4% of practitioners from South America assess their proficiency using BIM as "advance" or "expert", which were the two lowest rates over all regions globally. This may imply that in developing regions where cast-in-place concrete is more popular, the level of BIM proficiency is the lowest, which describes the incipient industrialization of construction in these regions. As example, a research study related to BIM adoption in Peru (Murguía, 2018), stated that 91% of building projects executed by large contractors (having more than 250 employees) implemented BIM, but small companies (having fewer than 50 employees) implemented BIM only in 22% of their projects. Also, 93% of the projects only implemented a volumetric representation of the reinforced concrete structures in the BIM model (not formwork or steel reinforcement). Another important result of Murguia's study is that almost 60% of the projects received very little or no BIM services from formwork providers.

2.3.1 Formwork management using CAD.

Most contractors and formwork companies use in-house CAD tools or "Plug-ins" to design, draw formwork layout plans, schedule list of elements and manage inventories. This section will present the tools used by two of the top formwork companies in the world, Peri and Doka. According to (PERI, 2020), Peri has more than 9,500 employees worldwide, presence in more than 60 countries, and has more than 160 logistics centers. Similarly, according to (DOKA, 2020), Doka has more

than 7,400 employees worldwide, presence in more than 70 countries, and has more than 160 locations worldwide.

Peri ELPOS (Figure 2.13) is an AutoCAD “Plug-in” tool for planning Peri’s formwork systems and scaffolding systems. ELPOS can generate formwork layout drawings in AutoCAD as well as the list requirement of formwork components that can be also exported to MS Excel. ELPOS matches both the total list of elements/components required and the list of owner-owned elements/components and generates a new list with only the additional components necessary for renting. Peri CAD is another AutoCAD “Plug-in” tool used by more experienced CAD users to design formwork and scaffolding, and that allows 3D modeling for obtaining layout drawings and materials list in a fraction of time.

Doka Formwork Design software (DFDS) 9 is a package for designing formwork that includes “Tipos 9” for automatic formwork planning with generation of plans and parts lists, “Piece List Editor 9” for editing the formwork parts lists, and “Beam Static 9” for calculating continuous load bearing beams. The advantage of this package is that it does not need a CAD platform for implementation. Doka CAD 9 (Figure 2.14) is a “plug-in” for AutoCAD for planning formwork layout plans and generating parts’ lists. Doka CAD has country versions only for Austria, Germany, UK, USA, and France that provides access to updated libraries and the database of the components available in stock in local warehouses. In other countries, Doka CAD is available only for Doka staff who have a user account. Also, Doka CAD installation needs authorization from Doka, and is typically available only to Doka customers.

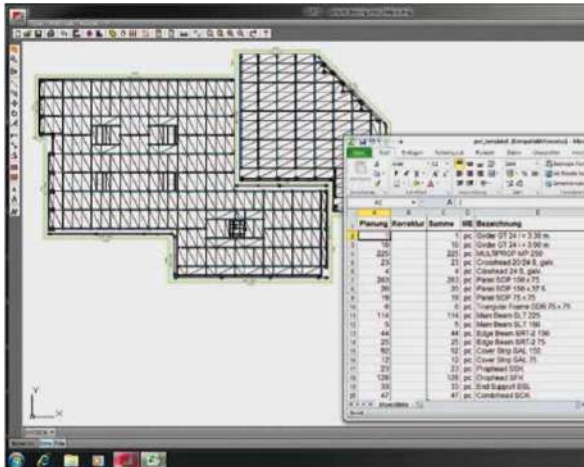


Figure 2.13. ELPOS from Peri

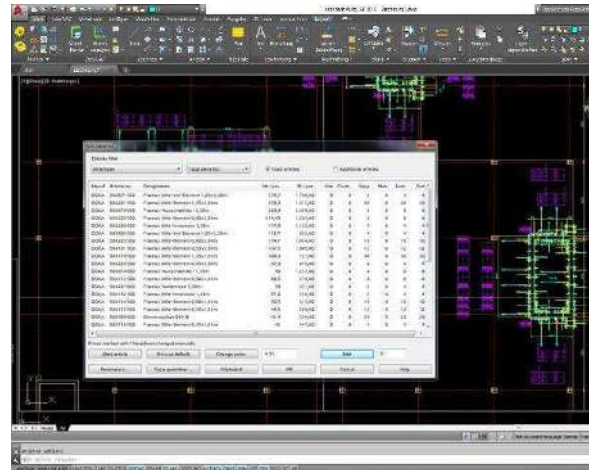


Figure 2.14. Doka CAD 9 from Doka

2.3.2 Formwork management using BIM.

Both Doka and Peri have started a migration process from CAD to BIM in formwork planning and management. Peri CAD (see Figure 2.15) has a 3D modeling environment that can process the Industry Foundation Class (IFC) format from a BIM tool (i.e., Revit, Tekla). Once the BIM model of the building structure is incorporated in Peri CAD the process for designing the formwork and detailing the layout plans can be done in a fraction of time, and the 3D model of the formwork solution can be shared through a “Common Data Environment” (CDE) such as Autodesk BIM 360 Glue or exported to Navisworks.

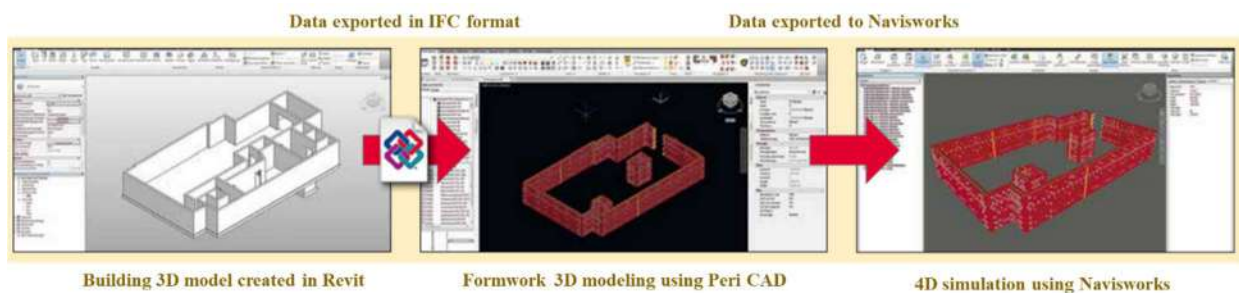


Figure 2.15. Integration of PERI CAD in the BIM process

Doka CAD 9 has evolved to a “plug-in” available for BIM tools like Revit (see Figure 2.16) and Tekla. Doka CAD 9 enables users to: (1) create 3D models and formwork designs using the structural data of the components (such as materials properties, load capacities, and dimensions) that enrich the BIM model, (2) detail 2D layout drawings, (3) create lists of formwork pieces

required, and (4) implement 4D simulations. Doka also provides an extensive library of the 3D components of their formwork systems (available on Doka’s website) for use in Revit and Tekla.

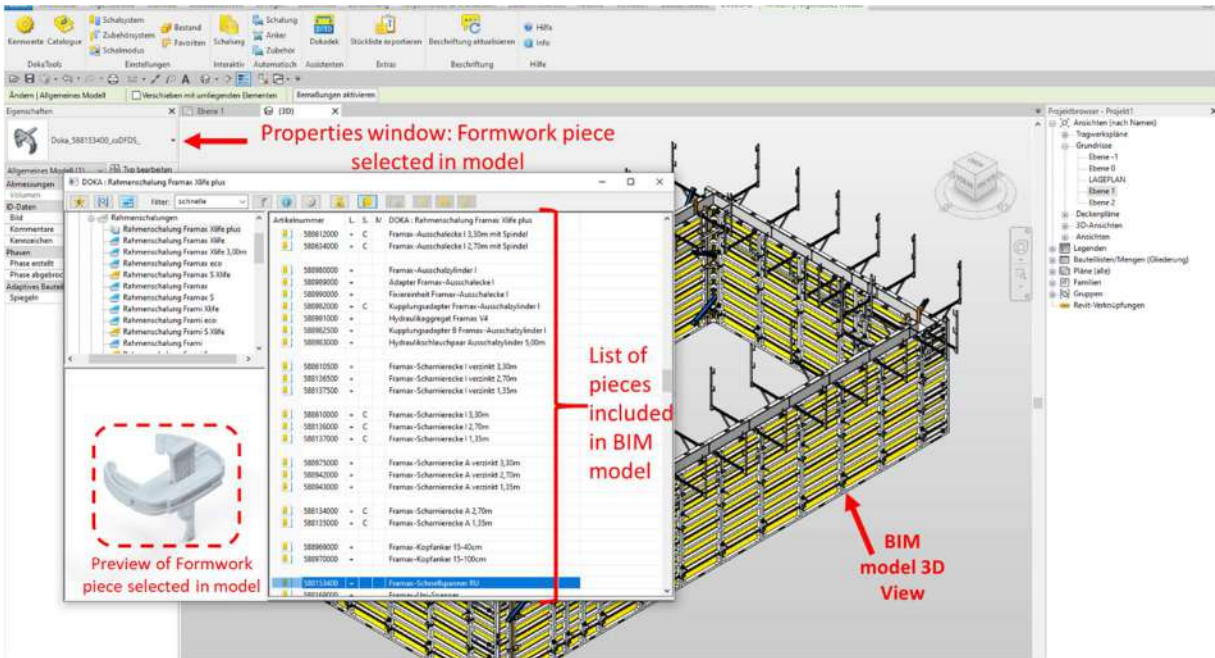


Figure 2.16. Doka CAD for Revit

2.4 Needs assessment.

Cast in place concrete for building projects is the preferred construction method in developing regions like South America, in contrast to developed regions like North America and Europe where the use of modular construction and prefabrication are the preferred construction methods for buildings. The main reasons for the preference of developing countries for using cast in place concrete are: (1) the lack of expertise using other materials like structural steel, (2) the incipient production of prefabricated elements like steel members, and (3) the low labor cost in comparison with developed countries. Since this thesis focuses on the use of formwork, a survey was deployed to professionals in the AEC community with experience in building projects but with a higher representation of countries from South America where the use of formwork is the preferred construction system. According to (Peters, 2020), the three countries from South America that are included in the top 5 of Latin American countries with largest revenue of construction projects are: Brazil (that represents 28.1 %), Chile (that represents 25.6%), and Peru (that represent 8.9%).

To measure the preferences of the AEC community related to formworks and BIM, a survey request was sent to professionals from USA and countries of Latin America (Bolivia, Chile,

Mexico, Panama, and Peru). The total number of responses was 136. Figure 2.17 shows the proportion of the respondents, where Peru has the majority with 79%, then USA with 12% and the remaining from different countries from Latin America. Almost half of respondents are employees of medium companies (between 50 and 250 employees), and large companies (more than 250 employees). The survey includes questions related to: LOD preference for modeling formwork systems, formwork rental option preference, and level of automation in formwork management tasks.

Figure 2.18 shows that 68% of survey respondents have between 5 and 20 years of experience on construction projects. Figure 2.19 shows the classification of respondents into four groups: (1) formwork clients which are represented in majority by general contractor practitioners (49% of respondents), (2) BIM experts that represent 32% of respondents, (3) the academia representing 7%, and (4) formwork providers which are represented by managers and sales representative of the most representative formwork companies like Doka, Peri, Ulma, Alsina, EFCO, Unispan, Forsa, and MFE (represent 12% of respondents to the survey).

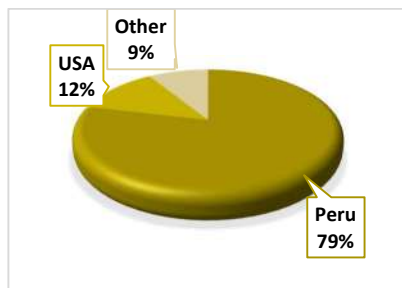


Figure 2.17. Country of participants

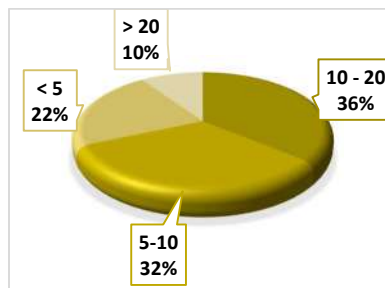


Figure 2.18. Years of experience of participants

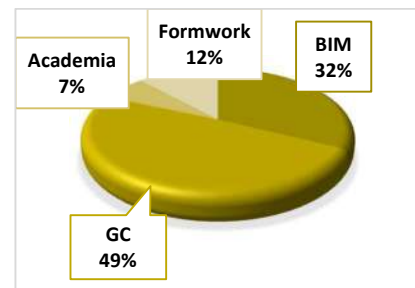


Figure 2.19. Professional profile of participants

Level of Development (LOD) preference

According to (BIMForum, 2015), Level of Development is the degree to which the user of the BIM model can rely on the information provided by the model. In a LOD 100 specification, the model is represented as a generic representation. In LOD 200, the object is represented as a generic system with approximate quantities, size, shape, location, and orientation. In a LOD 300 the element model is represented as a specific system in terms of quantity, size, location, and orientation. In LOD 350, the object is also specific in terms of interfaces with other building systems. In LOD 400, the object also provides information for fabrication, assembly, and

installation. In LOD 500, the object is a field verified representation. A representation of each LOD specification for a column formwork is presented in Figure 2.20.


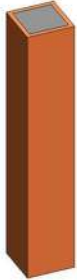

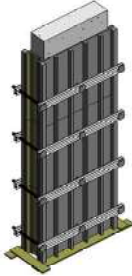


LEVEL OF DEVELOPMENT (LOD)						
	LOD 100	LOD 200	LOD 300	LOD 350	LOD 400	LOD 500
DESCRIPTION	Cost is a numeric parameter	Column formwork, generic/ approximate size/ shape/location	Design specified handset, specific size/shape/ location	Actual formwork system from a specific provider, specific size/ shape/ location	As 350, plus special mounting details, as hardware and ties	Field verified, model as-built
REPRESENTATION						

Figure 2.20. Level of Development (LOD) for a column formwork

Figure 2.21 shows that 64% of formwork companies can provide BIM models at LOD 400 or greater. In contrast 62% of the general contractors prefer modeling formwork systems at LOD 200 or lower, indicating that although companies such as Doka and Peri provide BIM services, these services are not normally used by general contractors in their building projects.

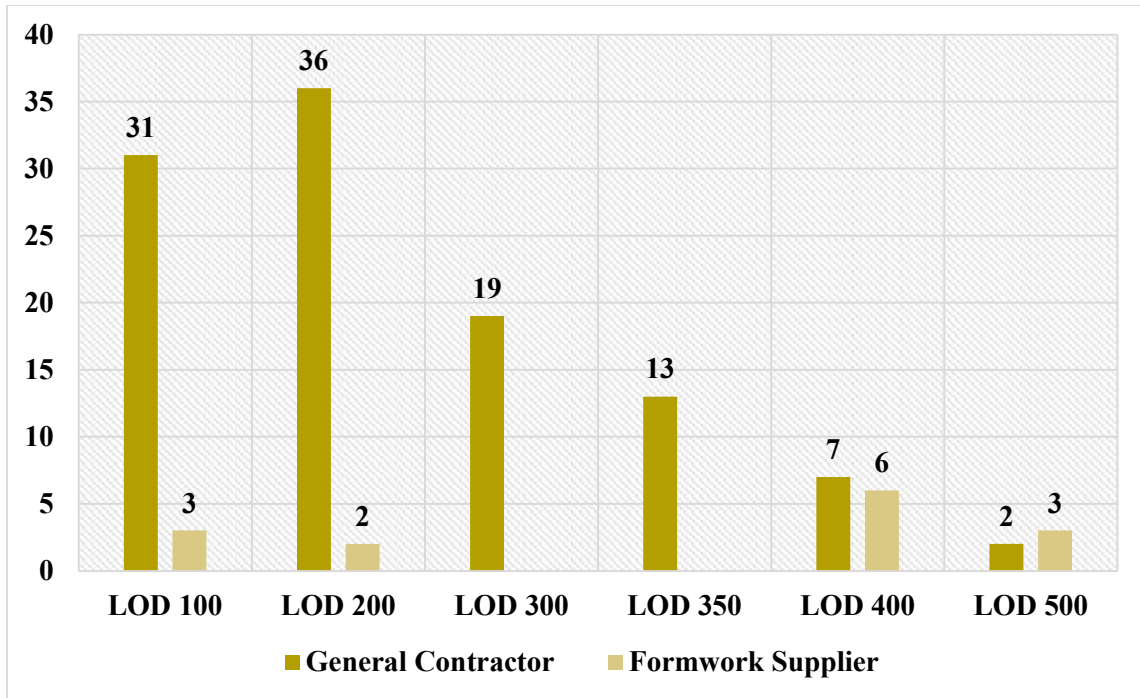


Figure 2.21. LOD preference of general contractors and formwork providers

Formwork rental option preference.

There are two main formwork rental options (price by solution system and price by component). The survey results indicated that renting by a formwork solution system measured in contact area, is the preferred option. Although formwork companies provide both rental options, contractors and suppliers prefer to rent formwork by solution, since it is easier to compare different proposals in the same unit (m^2) instead of comparing different formwork components, where the type of components from one formwork brand could be completely different from another brand. Another advantage of renting formwork system considering the contact area, is that controlling the amount of formwork required at any time of the project is easier to express in terms of variation of the contact area of formwork required instead of computing the number of formwork components of each type in the solution system. An important consideration is that even when renting formwork by contact area of the solution system, it is recommended that keep the track of the inventory of components, since it will be necessary on some occasions to return pieces of one system or require additional pieces that were not considered in the initial requirement (for example, when a structural designer changes the depth of a beam).

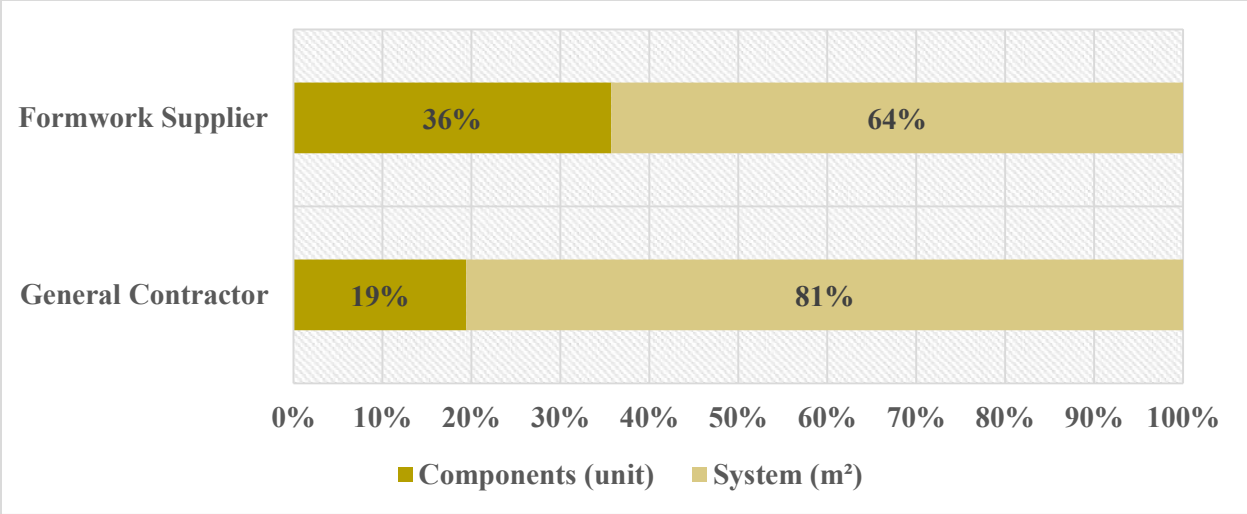


Figure 2.22. Formwork rental option preference.

Formwork level automation

Figure 2.23 shows that 31% of general contractors prefer using CAD for work zoning and managing formworks (quantity takeoffs, formwork layout plans, progress control, etc.). Also, 33% of the general contractors complement CAD with spreadsheets in Excel for computing quantities for work zoning and formwork management. Only 17% of contractors use BIM for work zoning or formwork management, indicating there is room to implement BIM methodologies for automating tasks related to work zoning and formwork management.

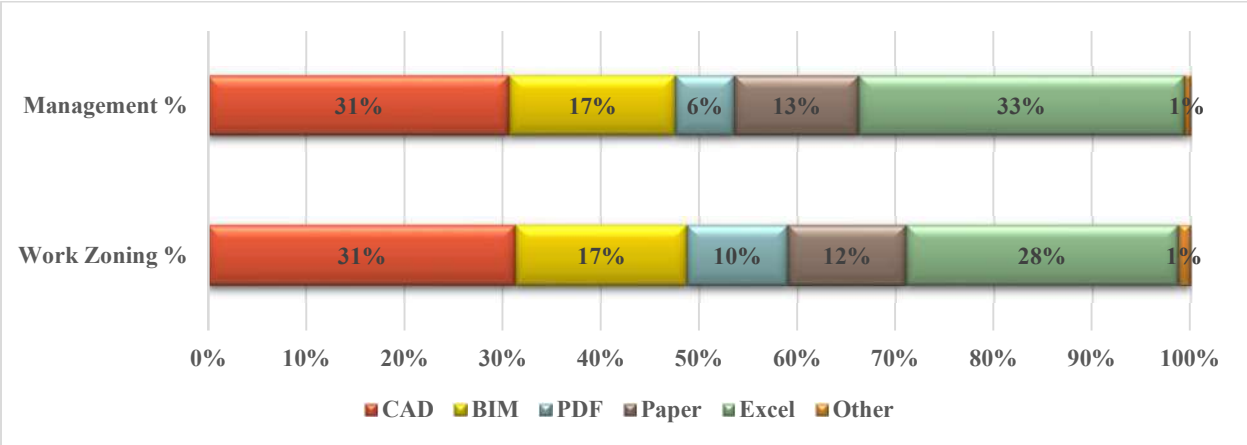


Figure 2.23. Computational tools preferred by general contractors for formwork management.

Defining a scale of level of automation from “Level 0” to “Level 4”, where zero is none and four is completely automated using a Graphical User Interface (GUI), the survey results shown that 58%

of formwork companies do not have any formwork management process automated although 29% of companies use BIM technologies. Also, 70% of contractors do not automate any process related to formwork management using BIM tools.

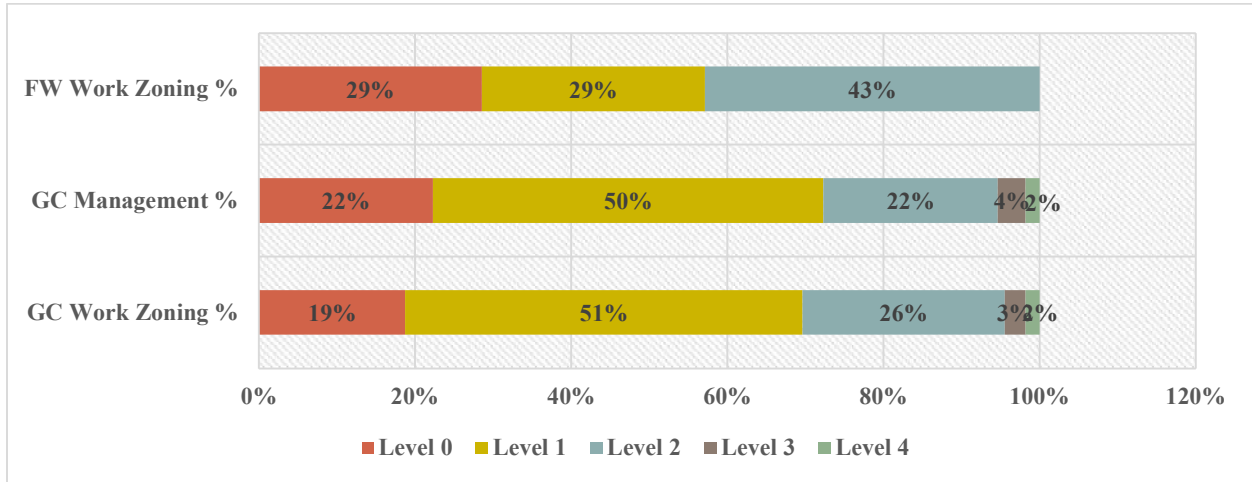


Figure 2.24. Level of automation preference by contractors and formwork companies

2.5 Summary

Many studies have investigated formwork design and selection, but few have focused on formwork management. Review of the state of practice as well as the results of the survey undertaken as part of this study, indicate that contractors prefer using simple BIM models (LOD 200 or lower) for formwork management even when formwork suppliers have BIM services to model formwork systems considering all components (LOD 400 or higher) and to use higher LOD models for planning and managing formwork. A new alternative is required to avoid modeling each component of a formwork system since the modeling and updating process of a formwork BIM model (considering all the components in a LOD 400 or higher) is time consuming. Since contractors and suppliers are more likely to use formwork rental options per solution measured in contact area, a new BIM approach could be used to develop an easy-to-implement tool that is automated and is more efficient than the current practice of using only CAD and spreadsheets.

3. RESEARCH METHODOLOGY

A BIM formwork model should: (1) communicate the information regarding formwork locations and areas considered for forming and shoring, (2) assist in the visualization of the characteristics of the construction process using multiple views, color mapping and 4D simulations, and (3) determine formwork-related information such as the total forming cost, the total shoring cost, determination of the quantities of plywood and consumables required, or determine the transportation requirements for delivery of formwork.

This chapter describes the first phase in the development of a BIM-based tool for formwork management. This phase focuses on the automation of formwork modeling and model enrichment with data related to formwork. The input for the BIM-based tool is a structural BIM model of a building. The BIM-based tool is developed using visual programming in Dynamo for Revit. The output of the BIM-based tool is a BIM model enriched with formwork related data that can be used for: (1) a geometric representation of the formwork contact area of each element type using a 3D model, (2) 4D simulation that helps in better understanding of the construction sequence and reuse schema, and (3) a 5D simulation for formwork cost management.

3.1. BIM workflow automation

The automation of BIM processes refers to the use of programming to recreate a workflow in a BIM tool without the necessity of the user, for performing repetitive tasks, ensuring the quality of the process through the reduction of human error during the streamlining of BIM processes. Common uses of BIM automation may include auditing of BIM models, modeling from references, quantity take-off generation, documentation, exchange of information to different software packages, exploring multiple alternatives of design, and project collaboration.

There are two main alternatives for developing BIM automation tools: (1) visual programming using packages like Dynamo for Revit that may include the use of programming languages such as Python for specific cases, and (2) use of an “Add-In” which is a software program (customized developed by user/programmer) that expands the capabilities of a host software program (like Revit). These “Add-ins” are solely based on the use of object-oriented programming and programming languages like Python and C# in combination with an “Application Programming Interface” (API). API is a communication mechanism that a programmer uses to interact with the host software program.

Dynamo for Revit is an open-source graphical programming tool that is based on the use of nodes that are interconnected to recreate a BIM workflow, as shown in Figure 3.1. In Dynamo each node represents a process in Revit and nodes are interconnected through “wires” or links with other nodes. The output of one process or node is sent as an input to the next interconnected nodes downstream through the “wires”.

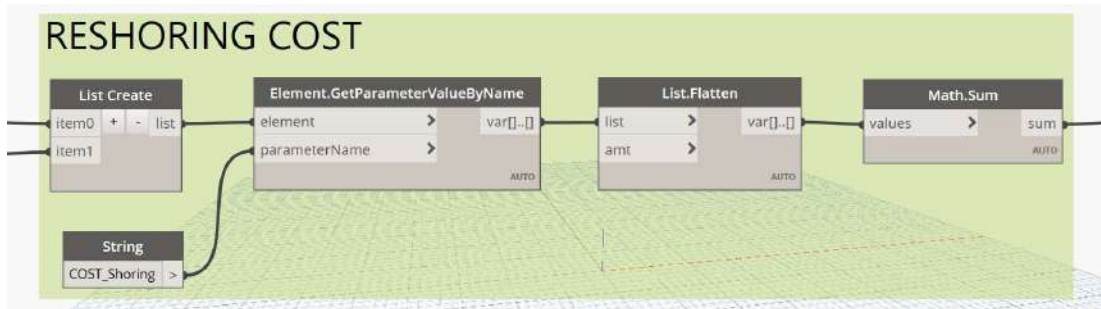


Figure 3.1. Dynamo workflow for reshoring cost sum for all horizontal elements

Both options Dynamo and Add-ins have advantages depending on the needs of the user/developer (what the tool should do) and the user/developer requirements (how the tool should work). Dynamo is user friendly, and could be implemented faster than a Revit Add-in, but it sacrifices the potential for creating Graphical User Interfaces (GUI), and compromises on speed for running the algorithms. Table 3.1 presents a trade-off for deciding which tool should be used depending on the requirements of the user and developer. Since the objective of the thesis is to develop and evaluate a prototype formwork management tool using BIM, all the automation processes presented in this thesis will be based on Dynamo. The processes will also be enhanced with Python custom nodes specially for the loop structures that are not very efficient with the built-in nodes included by Dynamo.

Table 3.1. Dynamo and Add-Ins trade-off

Criterion	Dynamo	Add-Ins
Coding source	Open script	Closed coding
Programing languages	Visual programming	Python or C#
Popularity	Users increasing rapidly. Dynamo BIM Forum around 29,200 users in 2018 and around 39,800 in 2020 (Dynamo BIM, 2021)	Fewer developers since strong programming skills, and knowledge of programing languages are required.
Data processing	Processing speed is affected by size of geometry data that is processed.	Processing speed will depend primarily on the computing resources (memory and CPU)
Cost of scripts and Add-ins in market	Are available for free in “Packages Manager website”.	Free and paid options in Autodesk App Store.
Versioning updating	Depends on Revit updates	Depends on the developer.
Programming skills	Knowledge of specific programming language is not required	Need of programing languages like Python, C#, and programing skills. Knowledge of Revit API is required.
Developing time	Depends on number of nodes in script. Generally, a single node can replace multiple lines of coding.	Depends on number of coding lines. Multiple lines are needed to represent one single node.
Customization	Task manager of Dynamo only provides a standard user interface, and is amenable to customization of user interfaces	The Graphical Use Interface (GUI) can be designed according to the requirements of the user/developer.
Data security	Minimum since a Dynamo script cannot be compiled.	High once coding is compiled
Implementation stage	For prototyping stage of a new tool	For developing tools that are ready to be released into the market
Use frequency of tool (Dynamo script or Add-in)	Fewer uses (just to try an idea)	High use (common process in a BIM workflow)

3.2. Road map for developing the framework for formwork management using BIM.

The development of the BIM-based formwork management tool consists of two phases: Phase 1 for generating the formwork BIM model and Phase 2 for using this BIM model to deploy formwork management. There are five steps in Phase 1, for obtaining a BIM model with enriched data. Phase 2 consists of six steps towards the determination of formwork cost and time analyses for formwork management. Chapter 3 describes Phase 1, which includes: (1) BIM parameters management, (2) audit of BIM model according to construction process, (3) work zoning, (4) formwork modeling as LOD 200, and (5) populating information into the BIM model. Chapter 4 describes Phase 2 for using the BIM model enriched with data for multiple formwork analyses.

Figure 3.2 presents the roadmap for the first phase of the BIM-based formwork management tool. Each step in Phase 1 is represented by a column that mentions in the header the specific section in Chapter 3 which contains a detailed description of that phase. An image of the logo of the tool (Excel, Revit, Navisworks, etc.) used in each step is next to the corresponding box (that represents an input, process, or output) for better understanding of what tools are required for each process. The dashed border of process boxes in Step 2 indicates that this is an optional step depending on the characteristics of the BIM model used as an input. For instance, if the BIM model elements that represent columns, walls, beams, and slabs were modeled considering the audit modeling criteria required for using this BIM-based tool (columns should be split at the bottom of the deepest adjacent beam, walls should be split at the bottom of the deepest adjacent slab and slabs should be modeled considering a boundary due to surrounding walls and beams), then this step it is not required.

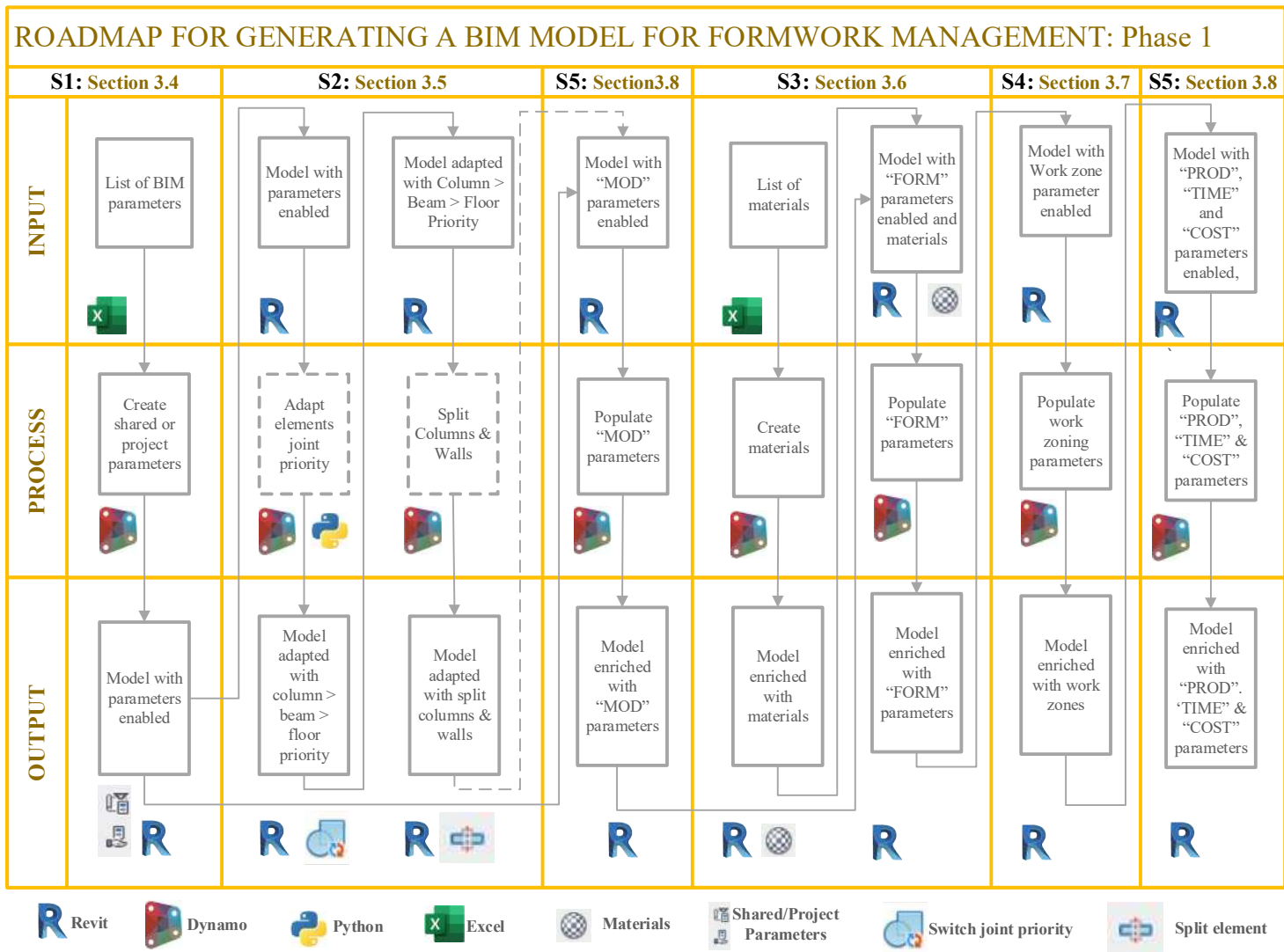


Figure 3.2. Road map for generating a BIM model for formwork management.

3.3. BIM parameters management

According to (Autodesk Help, 2021) a “parameter” is a container of information that could be assigned to any “category” of element created in Revit. Parameters are used to define and modify elements and their values can be inserted in schedules (or tables of quantities) to enable the user to obtain relevant information for multiple analyses. There are four types of parameters (project parameter, shared parameters, family parameters and global parameters). In this research study, only project and shared parameters will be necessary for storing the information required for formwork management. Table 3.2 provides a brief description of each parameter group.

Table 3.2. Parameters' groups

Parameters' Groups	Description
Model	Collects basic characteristics of the structural elements regarding typology (element type, pouring phase), geometry (height, depth), quantity take-off regarding steel reinforcement, and location (level, work set, work zone). Concrete volume is a built-in parameter in Revit and formwork area is part of the next group of parameters.
Formwork	Collects basic information regarding the formwork area (lateral, bottom, and total area) and formwork weight rates for each type of solution system.
Time	Collects basic data regarding the stripping date and the timing for removing formwork and removing reshoring systems.
Productivity	Collects information regarding productivity indexes for placement of concrete, formwork, and steel reinforcement. Also, the total quantity of labor hours required for each structural element are considered in this group
Cost	Collects information regarding rental rates for each formwork solution system, and the total rental cost for forming and shoring a structural system. Also, the parameters related to the cost of consumables for vertical elements are considered in this group.

Revit elements follow a hierarchy where “Category” is the highest level (for example, Structural Columns), then the second level is for the “Families” (for example, M_Concrete-Rectangular Column), the third level is for the “Type” (for example, 450x600mm) and finally the “Instance” which is the specific element that is included in the model with a specific id (for example, 420307). Figure 3.3 shows this hierarchy level example where the element instance “420307” represents a column type “450x600mm”, that is a typology of the “Family Type” named “M_Concrete-Rectangular Column”, which is available for all the elements classified as “Structural Columns”

category. The “Categories” to be considered in this thesis are: “Structural Foundations”, “Structural Columns”, “Walls”, “Structural Framing”, “Floors”, and “Stairs”.

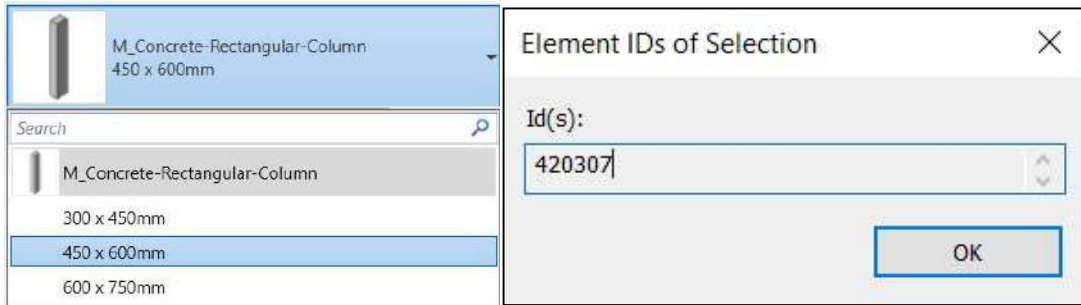


Figure 3.3. Hierarchy of Category, Family, Type, and Instance

The following questions must be considered when working with parameters for the BIM-based formwork management tool: (1) which parameters will be necessary for formwork management? (2) in what format (text, number, area, length) would the parameters store the data? (3) are the values stored by the parameters assigned for each instance or for the family type? and (4) what are the categories of elements that will be enabled with these parameters? In general, all the parameters in this research project are assigned independent values for each instance. Figure 3.4 lists the properties of the parameters.

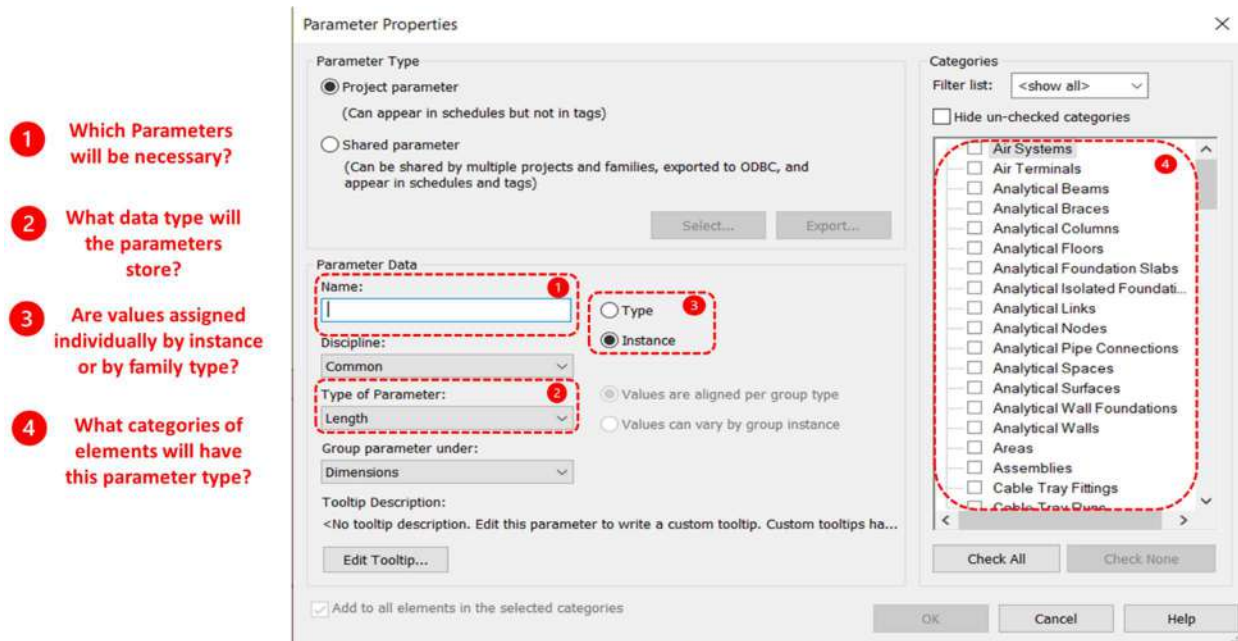


Figure 3.4. Parameter properties

Model parameters (MOD)

Model (MOD) parameters store information about elements related to type, geometry, rebar quantities, and location. Table 3.3 shows the list of MOD parameters.

Table 3.3. MOD Parameters - Group: MODEL

Parameter Name	Description	Data Type	Category List
MOD Element	Type of element (Column, Beam, ...)	Text	Structural Foundations, Structural Columns, Walls, Structural Framing, Floors, Stairs
MOD Height	Type of height (S, D, T)		
MOD S Level	Level of the element (L1, L2, ...)		
MOD S WorkSet	Work Set, default value is WS1		
MOD S WorkZone	Work Zone name (WZ1, WZ2, ...)		
MOD S F/V/H	Phase (Vertical, Horizontal, Foundation)		
MOD S Code	Construction sequence code		
MOD Steel Ratio	Steel ratio in kg/m ³	Number	
MOD Steel	Steel quantity by element in kg		
MOD Beam_Depth	Type of beam depth	Text	Structural Framing

MOD_Element: Elements needs are renamed based on the category with one of the following types: Foundation, Column, Wall, Beam, Slab, Stair and Joint. “Joint” is the part of the column that is at the intersection with the beams that they support. The “Joint” is separated from the “Column” because concrete placement of the column is typically done until the bottom of the beam. During the slab pour the remainder of the column is placed. Figure 3.6 shows an example of the corresponding parameter value for each element.

MOD_Height: Formwork height is an important consideration for formwork design since will be related in case of vertical elements (like columns and walls) with the lateral pressure on the forms, and in case of horizontal elements with the bracing required to avoid buckling of props. To simplify the analysis, the formwork solutions are classified as “Simple Height S” (height < 3.60m), “Double Height D” (3.6m < height < 6.7m), or “Triple Height T” (height > 6.70m). These ranges could be customized according to user preferences.

MOD_Level: A standard name is used for identifying the levels starting from “Level 1” up to the top level of the building. By default, Revit considers Level 1 as the ground level. Figure 3.5 shows

the renamed labels in red to substitute for the original names created by default in Revit. The “MOD_Level” will store text values like “L1”, “L2”, and so on.

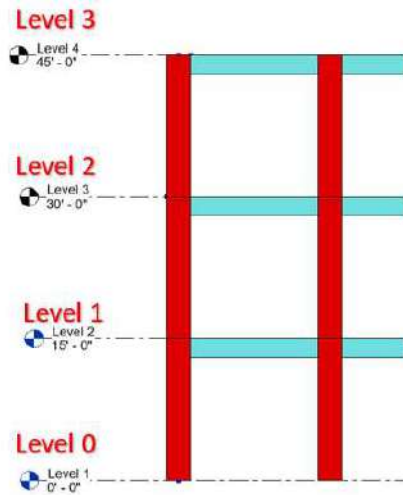


Figure 3.5. Renaming of levels for formwork analysis

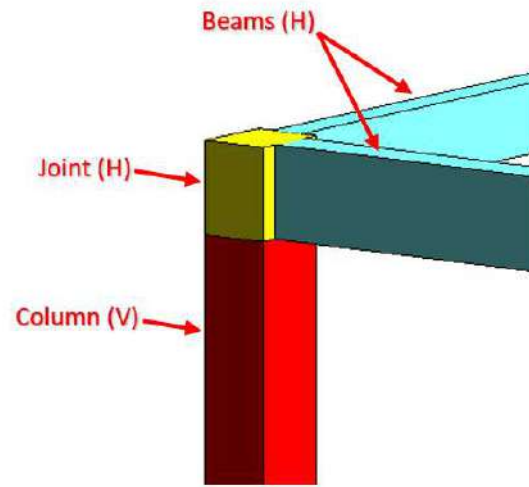


Figure 3.6. Joint element type parameter

MOD_S_WorkSet: This parameter stores the corresponding work set label for each BIM element. A work set is the work team responsible for the execution of a portion of the building project. Work sets common work simultaneously, and each work set has access to its own resources (tower crane, crews for each trade, superintendent, etc.). In this thesis, it is assumed every BIM model is executed by only one work set. It is possible for large projects multiple work sets can work simultaneously to compress the project duration (crashing).

MOD_S_WorkZone: The work zone is the portion of the building that is considered as a unit of work or a production batch.

MOD_S_F/V/H: This parameter stores data related to the concrete placement phase of the element. Typically, concrete placement is performed in two phases. In the first phase, concrete for vertical elements in a work zone is placed, and in the second phase concrete for horizontal elements in the same work zone is placed. Figure 3.6 shows an example for assigning the “MOD_S_F/V/H” parameter values. Figure 3.7 shows this first phase where concrete for columns is placed having as top level of the columns the bottom level of the adjacent beams. Figure 3.8 shows the first phase where concrete for walls is placed having as top level the bottom level of the adjacent slabs. Foundations are represented by (F). Columns and walls are considered as vertical elements and

presented by (V) and they are placed until the bottom of the beams and slabs, respectively. Slabs, joints, beams, and stairs are considered as horizontal elements and represented by (H).



Figure 3.7. Column poured until beam bottom



Figure 3.8. Wall poured until slab bottom

MOD_S_Code: This parameter represents a unique code to identify each work zone. The code must consider work set, level, work zone, and concrete placement phase. For example, a unique label for a work zone would be: WS1-WZ1-L1-V which refers to the vertical elements of the work zone 1 of level 1 of work set 1.

MOD_Steel_Ratio: Although it is not a common practice to common to model rebar in BIM models, it is important to include the working hours required for rebar installation. The “MOD_Steel” parameter is the ratio of rebar (in kgs) to the volume of concrete placed (in m³). This ratio will vary based on the type of concrete element placed (concrete walls, beams, columns, slabs, foundations).

MOD_Steel: This parameter stores the total quantity of rebar used as reinforcement in a concrete element expressed in kg.

MOD_Beam_Depth: The main consideration for designing beams’ lateral formwork is the depth of the beam. If beam’s depth is over 70cm, then ties, (Figure 3.9) rather than bracing squares (Figure 3.10) may be required to hold the side sheathings of the beam. Hence, for classifying beam formwork solutions for the beam formwork sides, the following classification of beam depths is proposed: depth Type 1 – T1 (beam depth < 0.40m), Type 2 – T2 (0.40m < beam depth < 0.70m), Type 3 – T3 (0.70m < beam depth < 1.00m), and Type 4 – T4 (beam depth > 1.00m). These ranges could be customized based on the user preferences and formwork features.

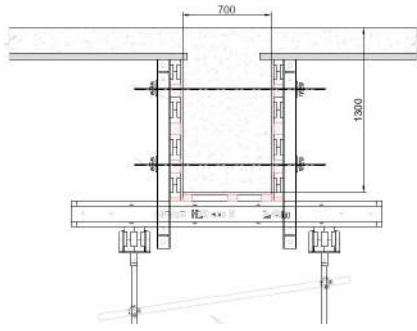


Figure 3.9. Doka beam lateral formwork with ties

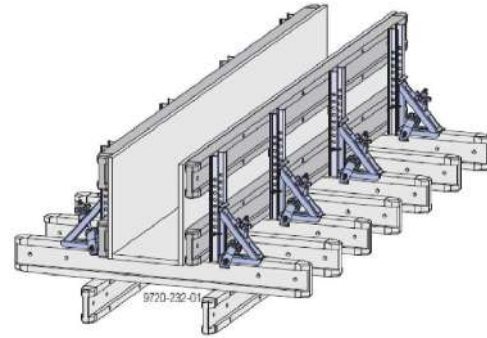


Figure 3.10. Doka beam lateral formwork with bracing squares

Productivity parameters (PROD)

Productivity parameters store the productivity indexes for the placement of concrete, formwork, and steel reinforcement. A parameter is reserved for the estimation of the total quantity of labor hours required for building each concrete element considering: (1) the steel reinforcement preparation and installation, (2) erection, stripping and preparation of formwork (including reshoring), and (3) concrete placing. Productivity indexes could be determined in terms of the construction trade and also by the element type. For instance, the productivity for placing concrete in columns will be different from productivity for placing concrete in a slab, but it is common to determine productivity without differentiating elements and just focusing on the trade. In this thesis, the productivity index will be specified by trades and not by element type. Table 3.4 shows the three productivity indexes considered (Rebar, formwork, concrete). The number of labor hours will be based on the product of the quantity takeoff for each trade and the corresponding productivity index.

Table 3.4. Productivity Parameters

Parameter Name	Description	Data Type	Category List
PROD_PI_Conc	Productivity index for concrete placement (labor hours/m ³ and labor hours by m ³ .	Number	Structural Foundations, Structural Columns, Walls, Structural Framing, Floors, Stairs
PROD_PI_Form	Productivity index for formwork in labor hours by m ² .		
PROD_PI_Steel	Productivity index for rebar in labor hours by kg.		
PROD_Labor	Labor hours for placement of a concrete element considering concrete placement, formwork erection and stripping, and rebar preparation and erection.		

Time parameters (TIME)

As shown in Table 3.5, Time parameters store the formwork stripping date for each element, the number of days when formwork should remain in place, and the number of days reshoring system is required to stay in place for a horizontal element.

Table 3.5. Time parameters

Parameter Name	Description	Data Type	Category List
TIME_Date_Strip		Number	Structural Foundations, Structural Columns, Walls, Structural Framing, Floors, Stairs
TIME_Form	The number of days formwork should remain in place		
TIME_Shore	The number of days that reshoring should remain in place		Structural Framing, Floors, Stairs

Formwork parameters (FORM)

Formwork parameters stores information related to the contact area for vertical elements, contact area for horizontal elements, weight ratios for formwork solution systems, and total weight of the formwork used for forming and shoring concrete elements. These parameters are shown in Table 3.6.

Table 3.6. Formwork parameters

Parameter Name	Description	Data Type	Category List
FORM_Dim_Lateral	Calculated area of the lateral faces of a concrete element that are in contact with forms.	Area	Structural Foundations, Structural Columns, Walls, Structural Framing, Floors, Stairs
FORM_Dim_Bottom	Calculated area of the bottom faces of a concrete element that are in contact with forms.		
FORM_Dim_Total	Calculated area of all the faces of a concrete element that are in contact with forms.		
FORM_Wt_Form_Lateral	Weight ratio (kg/m^2) of lateral forms for elements like walls, columns, beams, and foundations.	Number	Structural Foundations, Structural Columns, Walls
FORM_Wt_Form_Bottom	Weight ratio (kg/m^2) of a support formwork for horizontal elements.		Floors, Stairs
FORM_Wt_Form_Linear	Weight ratio in kg/m of a beam support.		Structural Framing
FORM_Wt_Shore_Linear	Weight ratio in kg/m of a beam re-shore system.		
FORM_Wt_Shore_Bottom	Weight ratio in kg/m^2 of a re-shore system for horizontal elements.		Floors, Stairs
FORM_Wt_Form_Total	Weight of formwork for a concrete element. It includes stringers, joists, props, braces, wales, studs and other accessories or hardware.		Structural Foundations, Structural Columns, Walls, Structural Framing, Floors, Stairs
FORM_Wt_Shores_Total	Total weight of a re-shore system for a horizontal concrete element. It includes the props, braces, accessories, and other hardware.		Structural Framing, Floors, Stairs

Cost parameters (COST)

Cost parameters stores the rental rates for forming and shoring solutions. The total rental cost for the forming or shoring solutions is estimated using Equation 3.1. Consumables like PVC tubes and

cones (see Figure 3.11) for vertical elements are separately calculated using Equation 3.2. Table 3.7 show the cost parameters implemented in the formwork BIM model.

$$\text{Rental cost} = \text{Contact area} \times \text{Rental period} \times \text{Rental rate} \quad (3.1)$$

$$\text{Consumables cost} = \text{Contact area} \times \text{Consumables cost rate} \quad (3.2)$$

Table 3.7. Cost parameters

Parameter Name	Description	Data Type	Category List
COST_Rate_Lateral	Rental rates for lateral forms including wales, studs, and hardware. (\$/m ² -day)	Number	Structural Foundations, Structural Columns, Walls, Structural Framing, Stairs
COST_Rate_Bottom	Rental rates for horizontal support including stringers, joists, props, and bracing (\$/m ² -day). Sheathing not included.		Floors, Stairs
COST_Rate_Bottom_Shore	Rental rates for horizontal re-shoring system. (\$/m ² -day)		
COST_Rate_Linear	Rental rates for beams support. (\$/m-day).		Structural Framing
COST_Rate_Linear_Shore	Rental rates for beams re-shore. (\$/m-day).		
COST_Rate_Consumable	Cost ratio (\$/m ²) for consumable materials like PVC cones and tubes. Only for vertical elements.		Structural Columns, Structural Framing, Walls
COST_Formwork	Total rental cost for formwork systems based on Equation 3.1		Structural Foundations, Structural Columns, Walls, Structural Framing, Floors, Stairs
COST_Shoring	Total rental cost for reshoring system based on Equation 3.1. Only applicable for horizontal elements (beams and slabs)		Structural Framing, Floors, Stairs
COST_Consumable	Total cost of consumables based on Equation 3.2. Only applicable for vertical elements (columns and walls).		Structural Foundations, Structural Columns, Walls



Figure 3.11 Formwork consumables

Automated creation of shared parameters.

Shared parameters can be used in multiple Revit families or Revit projects. Creating a shared parameter manually in Revit involves the following steps: (1) create an empty file with “.txt” extension, (2) create a group parameter, and (3) create a shared parameter assigning name, discipline, and parameter type. For the BIM-based formwork management tool, 36 shared parameters are needed, so the process must be repeated 36 times the first time the list of shared parameters is created. The advantage of shared parameters is that once the list is created and populated in the “.txt” file (see figure 3.12), this file can be shared with future projects and the parameters do not have to be created again.

```

JRR_Parameters_Test.txt - Notepad
File Edit Format View Help
# This is a Revit shared parameter file.
# Do not edit manually.
*META  VERSION MINVERSION
META  2      1
*GROUP ID      NAME
GROUP 1      MODEL
GROUP 2      FORMWORK
GROUP 3      TIME
GROUP 4      PRODUCTIVITY
GROUP 5      COST
*PARAM GUID   NAME      DATATYPE      DATACATEGORY  GROUP  VISIBLE DES
PARAM 268cbd0e-59dd-4109-9665-3ce787c535d0  MOD_Beam_Depth TEXT
PARAM ddbaa824-ced3-428f-b443-9283b2955fe3    FORM_Dim_Bottom AREA
PARAM 21796c2b-674b-4fb6-8548-cb0bc15be584  MOD_S_F/V/H    TEXT
PARAM c416f830-2f0h-4a40-9a20-087adhah5dc2  TIME Date Strin NUMRFR
  
```

Figure 3.12. Shared Parameters txt file.

Automating the process for creating the 36 shared parameters reduces the probability of mistakenly naming or assigning data type for the parameters. Any error at this stage could create conflicts when using the Dynamo scripts downstream in the workflow of the BIM-based tool. Using Dynamo, all the shared parameters can be created and assigned to the respective element category, eliminating the need to recreate the parameters each time. Figure 3.13 shows the Dynamo script for this task and Figure 3.14 shows the results when this script is executed.

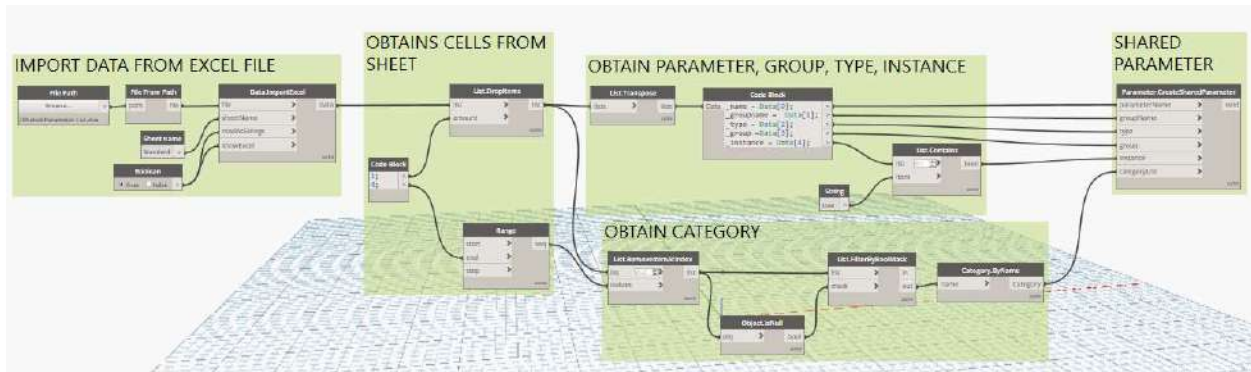


Figure 3.13. Dynamo Script for creating shared parameters from an Excel file.

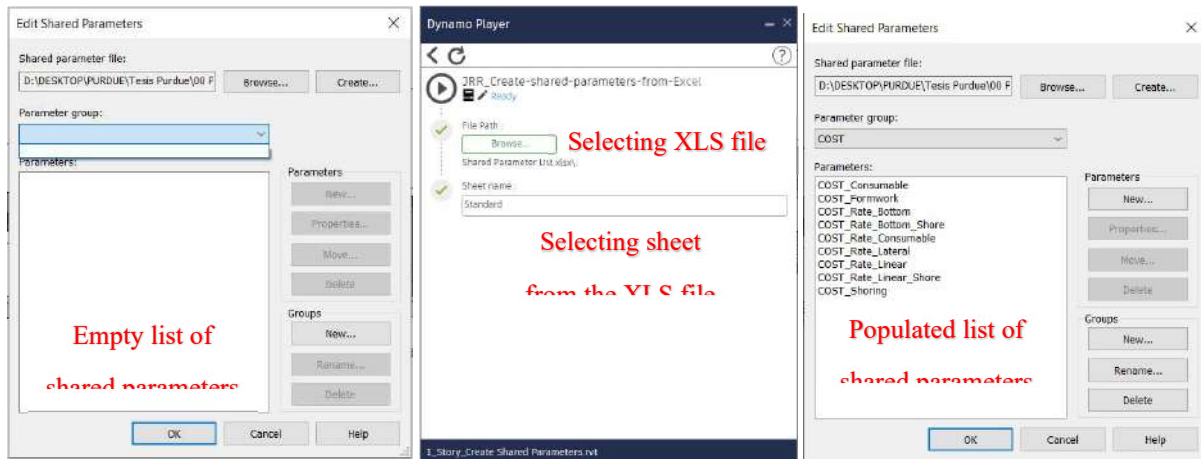


Figure 3.14. Results of running Dynamo Script for creating shared parameters

Automation for creating project parameters.

A project parameter in Revit is a container of information that is defined by the user and then added to multiple categories of elements in a specific project in Revit. Project parameters can be created one by one or can be massively loaded using a shared parameter file to avoid creating all the parameters again for each project in Revit. Project parameters are assigned to a list of elements' categories using the following steps: (1) create or select shared parameter (if the parameter is

created, then assign name, discipline, type of parameter, and parameter group), (2) define if the parameter is specific for every instance and not for a Revit family, and (3) select all the categories that have this parameter. This process could be time consuming considering the 36 project parameters that are required. Also, any human error in assigning the categories for each parameter can impede the workflow of the BIM-based formwork management tool. Figure 3.15 shows the empty list of project parameters before running the Dynamo Script for automating project parameter creation and the results of using this script.

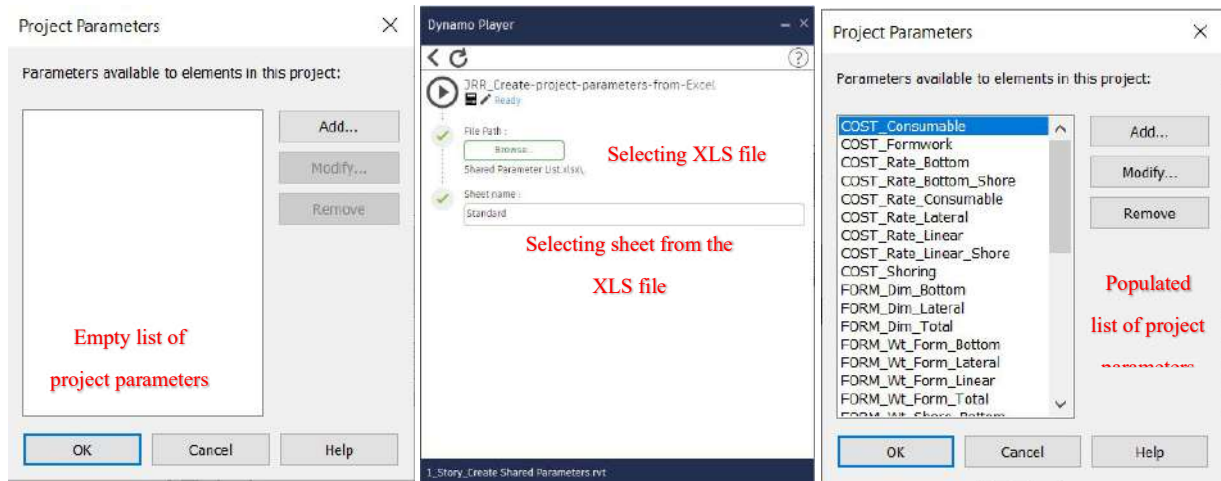


Figure 3.15. Result of running script for creating project parameters

3.4. Auditing the BIM model for formwork management

In Revit, structural elements have joint priorities, this joint priority is related to the placement of one element over others, based on the location of the joints. In Figure 3.16 the placement of the floor element has priority over the placement of the beams and the column, and in Figure 3.17 the placement of the column has the priority over the placement of the floor and the beams.

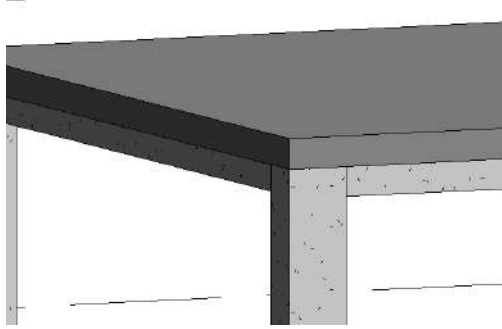


Figure 3.16. Floor priority over beams and columns

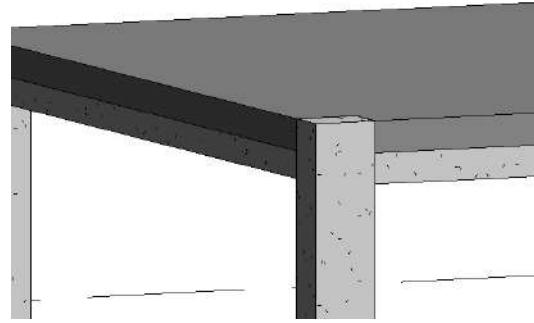


Figure 3.17. Column priority over the floor and beams

Since a BIM model can be generated without considering that columns have the greater joint priority placement, over the beams, and the beams over the slabs, the first step is aligning the model to the priority hierarchy of joint placement before running the Dynamo scripts. Changing joint placement priorities can be done manually in Revit with “switch priority” tool but since project has many “joints”, this process should be automated. Figure 3.18 shows the results of running the Dynamo script developed for changing the priority of the placement of structural elements. The inputs are the category of elements that will “switch” the order of priorities.



Figure 3.18. Results of running Dynamo script to switch element priorities

Vertical elements such as columns and walls are commonly built in two phases: in the first phase the vertical concrete element is poured only until the bottom of the horizontal element that intersects with it, and in the second phase the placement of the remaining vertical concrete element is completed once the horizontal elements are placed. If the columns and walls are modeled without this consideration (two phases of concrete placement), the BIM model can be edited using the “Split element” tool of Revit to divide all vertical element in two pieces, one for each concrete placement phase. If the BIM model was already modeled having this consideration, then there is no need to use the “split element” tool. Also, there may be cases as shown in Figure 3.19, where the columns are poured in one single phase since the columns are adjacent to steel beams, and hence, there is no need to “split” columns. Similarly, Figure 3.20 shows a monolithic wall -slab system, where there is no need to split walls into two phases.

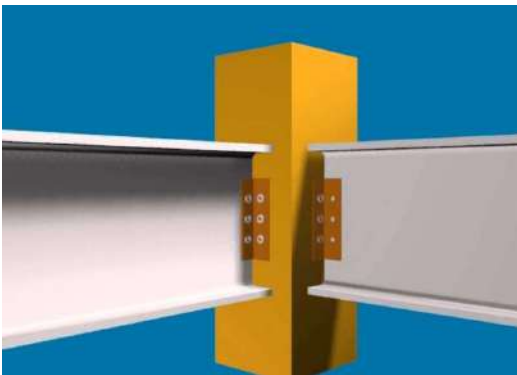


Figure 3.19. RC column and steel beam connection



Figure 3.20. Monolithic structure with tunnel formwork

The process of “splitting” vertical elements could be time consuming if it is done manually using “split element” tool in Revit. To address this challenge, a set of tools for “splitting columns and walls” was prepared using Dynamo. This tool set considers the options to split vertical elements by selecting one single element, by selecting multiple elements, by selecting all elements in a specific level or selecting all elements in the model. Figure 3.21 shows the results of the Dynamo script for splitting columns and Figure 3.22 shows the results of running the script for splitting walls.

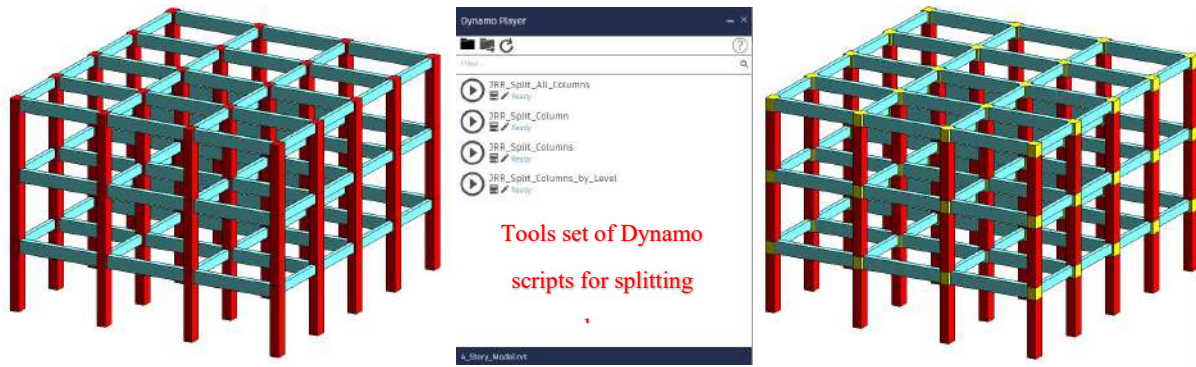


Figure 3.21. Results of Dynamo script for splitting columns

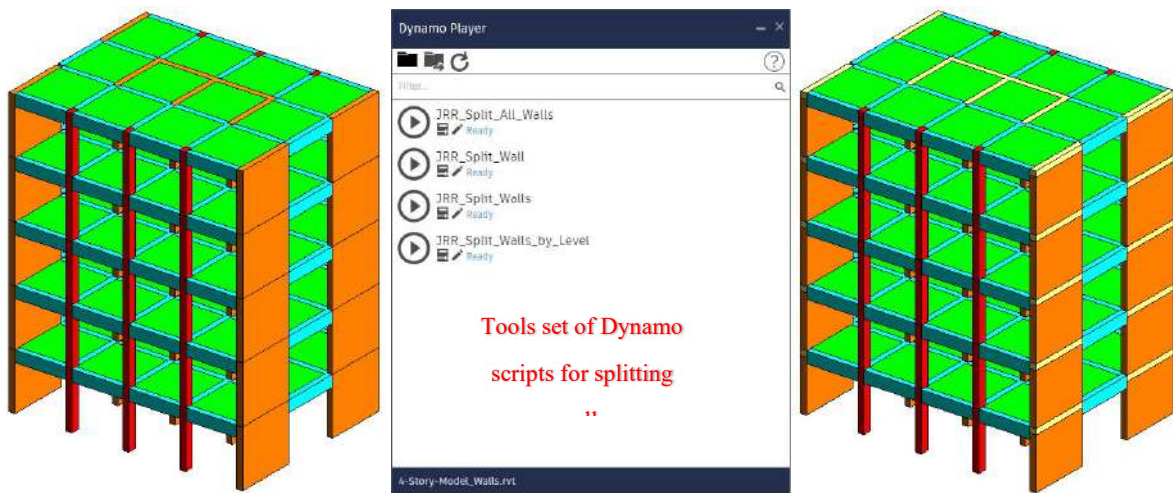


Figure 3.22. Results of Dynamo script for splitting walls.

The logic of the Dynamo script for splitting columns is: (1) select all columns, (2) for each column find the adjacent beam with the lowest bottom level, and (3) use the “Z” coordinate of this beam bottom level to “split” the column. Columns are created in Revit using the vertical axis that passes through the centroid of the column solid. In Revit, this vertical axis is named “curve”, and defines the height, start point and end point of the solid for 3D modeling the column. For “splitting” a column the process is: (1) generate two new “curves” to define the two new “columns” (one for each concrete placement phase), (2) generate the new two columns using these “curves” as generating path, and (3) delete the original column from the Revit model. A similar process is followed for the walls. However, since the “wall curve” is only the horizontal axis or path of the wall, instead of splitting the wall “curve”, a new wall for the “joint” element (wall and slab intersection) can be created in which the height will be defined by the slab depth. The “top offset”

of the original wall is then adjusted to the bottom of the adjacent slab. Figure 3.23 shows a high-level view of the nodes and workflow for splitting all columns in a BIM model using Dynamo.

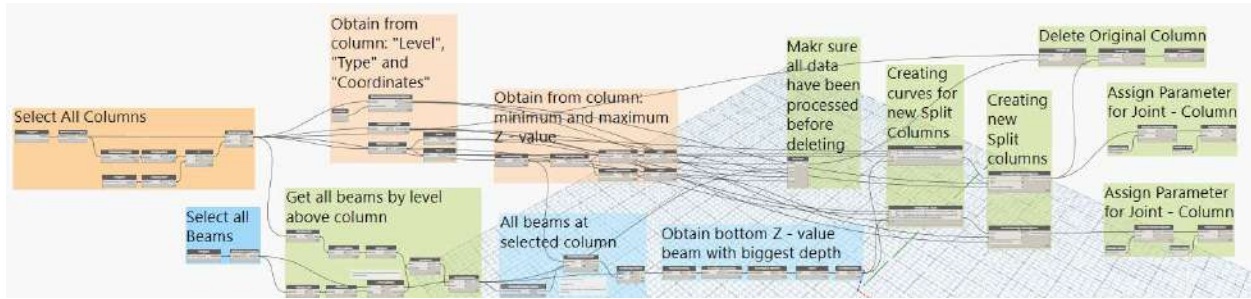


Figure 3.23. Dynamo Script for splitting all columns in the BIM model.

3.5. Work zoning process using BIM.

The objective of the work zoning process is balancing the workload between the work zones to reduce the variability of labor hours across different work zones. For this task, Revit has available the “schedules/quantities” tool. Since the BIM model is enriched with parameters related to steel reinforcement quantity ratios (kg/m^3), it possible to compute the quantity takeoffs for steel reinforcement using Equation 3.3 or using Equation 3.4 in terms of the “MOD parameters”.

$$\text{Steel reinforcement quantity takeoff} = \text{Steel ratio } (\text{kg}/\text{m}^3) \times \text{Concrete Volume } (\text{m}^3) \quad (3.3)$$

$$\text{MOD}_{\text{Steel}} = \text{MOD}_{\text{Steel_Ratio}} \times \text{Volume} \quad (3.4)$$

Since the BIM model is enriched with parameters related to productivity, it is possible to estimate the total number of labor hours for installation of each element, based on the quantity takeoffs and productivity index parameters of each element in Revit. Equation 3.5 is used for estimating the total quantity of labor hours for installation of each element, or the equation 3.6 in terms of the “PROD parameters”.

$$\text{Total labor hours} = P_1 \times Q_1 + P_2 \times Q_2 + P_3 \times Q_3 \quad (3.5)$$

Where:

P_1 = Concrete productivity index in terms of (hours/m^3)

P_2 = Formwork productivity index in terms of (hours/m^2)

P_3 = Rebar productivity index in terms of (hours/kg)

Q_1 = Concrete volume in terms of (m^3)

Q_2 = Formwork area in terms of (m^2)

Q_3 = Rebar in terms of (kg)

$$\text{PROD_Labor} = P_1 \times Q_1 + P_2 \times Q_2 + P_3 \times Q_3 \quad (3.6)$$

$P_1 = \text{"PROD_PI_Conc"}$

$P_2 = \text{"PROD_PI_Form"}$

$P_3 = \text{"PROD_PI_Steel"}$

$Q_1 = \text{"Volume"}$

$Q_2 = \text{"FORM_Dim_Total"}$

$Q_3 = \text{"MOD_Steel"}$

A quantity takeoff summary for each work zone could be generated converting all the BIM elements into “Parts”. A “Part” element inherits the parameters of the parent elements from which it was generated. Revit cannot combine in a “Schedules/Quantities” table elements type “host” (“Walls” and “Floors”) with elements “Family Type” (“Structural Foundations”, “Structural Columns”, “Structural Framing”), but converting all the elements as “Parts” then a “Schedules/Quantities” table can be generated as shown in Figure 3.24.

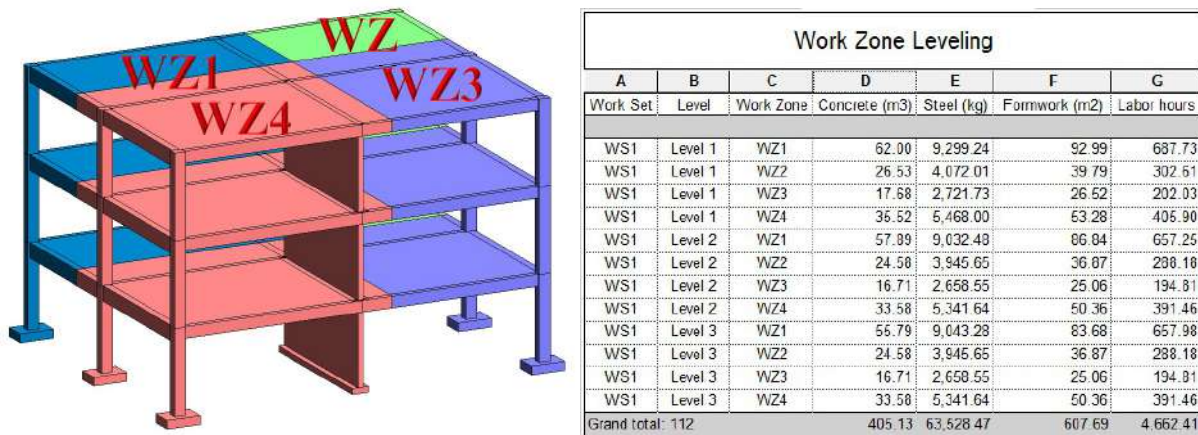


Figure 3.24. Work zone leveling using Parts and multicategory schedules

When concrete placement is planned, work zones are delimited by construction joints. However, when formwork installation is considered, each horizontal element should only be assigned a single work zone parameter value. Even though the construction joints are not used to “split” elements for formwork work zoning, these imaginary lines can be used for projecting them to the rest of the building floor plans and assigning work zones for every element. Using a Dynamo script, the work zoning process is automated using the following steps: (1) identifying to which work zone each element pertains, and (2) assigning the work zone name to the parameter

“MOD_WorkZone” for each element. The results of using this Dynamo script for work zoning are shown in Figure 3.25.

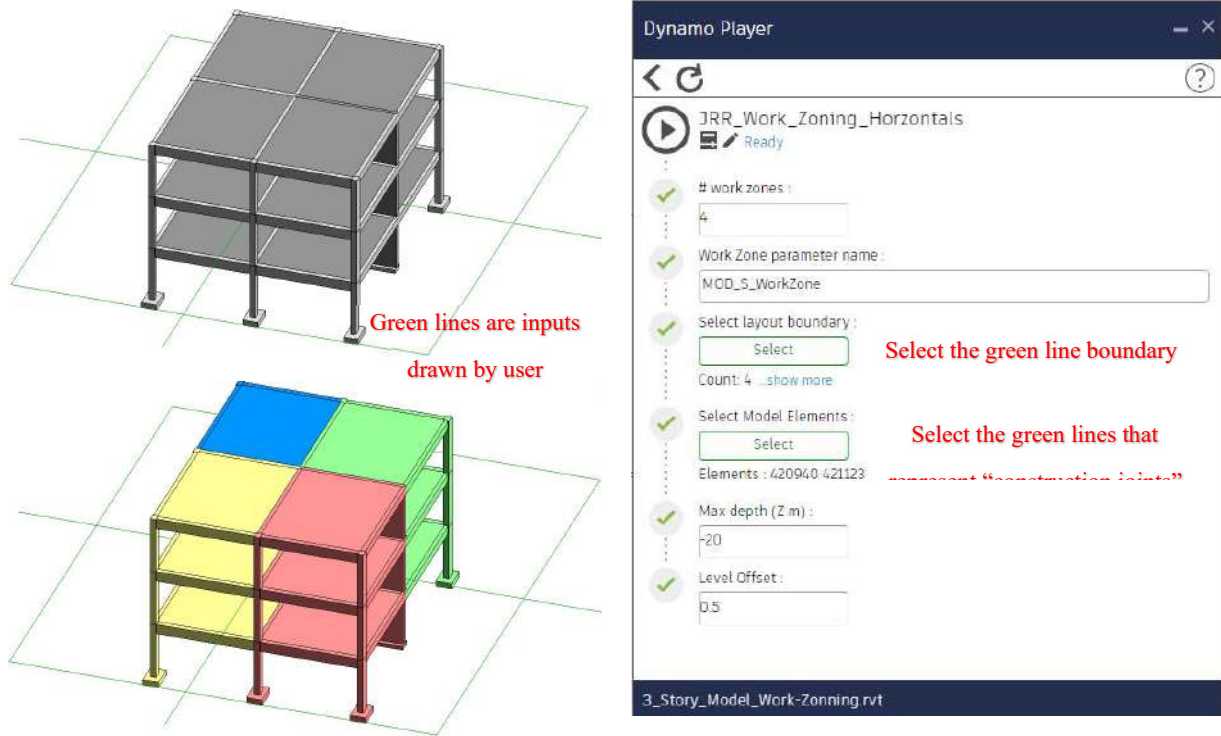


Figure 3.25. Results of running Dynamo script for work zoning

The workflow of the Dynamo Script for classifying each element in its respective work zone consists of creating a solid boundary for each work zone, collecting all the elements that are contained by each solid boundary and assigning to all these elements the corresponding work zone value (“WZ1”, “WZ2”, “WZ3”, “WZ4”). Figure 3.26 shows a general view of the Dynamo script design for work zoning a BIM model.

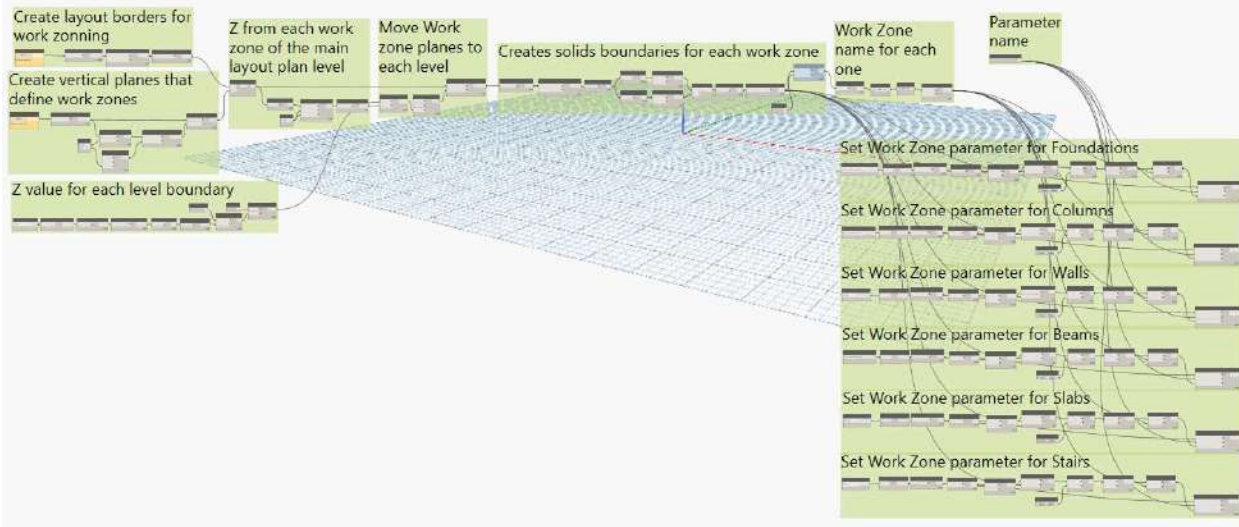


Figure 3.26. Dynamo Script for work zoning elements

3.6. Formwork modeling automation

As shown in Figure 3.27, an input for the formwork modeling script is the “Revit materials” that will be used to represent each formwork solution type and each “material” type is coded in a different color. Figure 3.27 shows the Dynamo script for creating a list of “Revit materials” and Figure 3.28 shows the results of running the script. This script needs as inputs a file path for an Excel file as well as the sheet name of the Excel file for reading the information. Using this information, the characteristics of the materials (name, appearance, and color) are generated. For instance, “Formwork_Beam” is blue, “Formwork_Column” is red, etc. (see Figure 3.28 and 3.31).

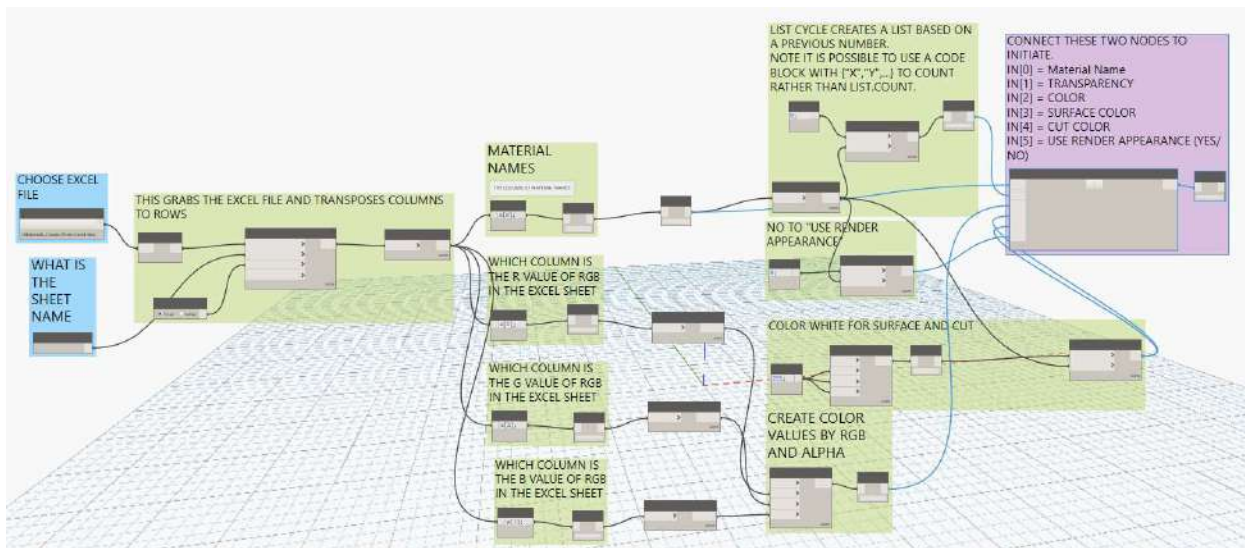


Figure 3.27. Dynamo script for creating materials.

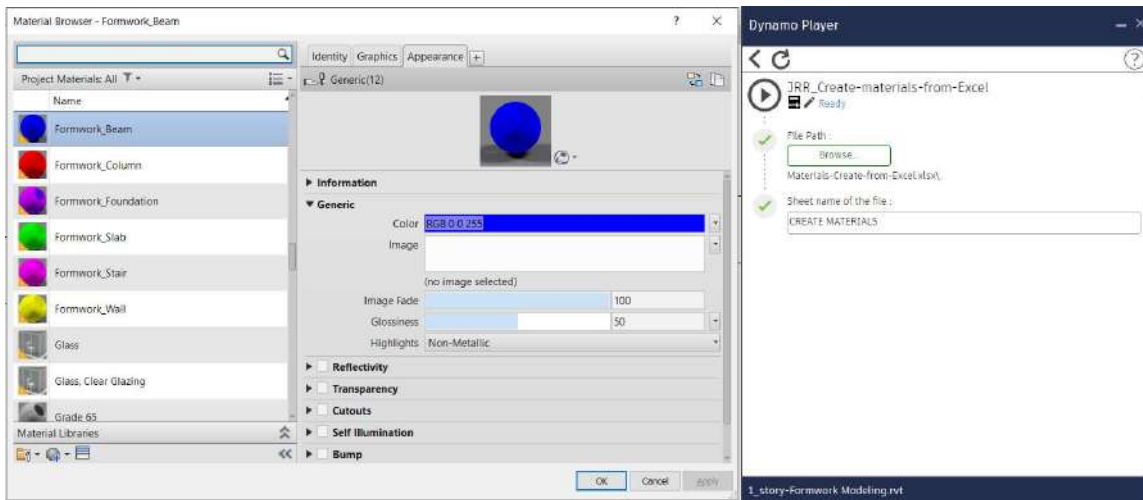


Figure 3.28. Results of running Dynamo script for creating materials

For a LOD 200 formwork modeling, the use of the “Generic Models” category could be sufficient for obtaining a general idea of the shape and location of formwork as well as the formwork area for each element in the BIM model (columns, beams, etc.) In Revit there is no tool available for computing formwork areas, so the computation must be done manually for each element. A common practice to use Revit for computing formwork surface area is using the “Paint” tool to apply a “material” coat to every surface that need to be formed. This process could be time consuming since a building has many surfaces that need to be formed.

A part of the Dynamo script for estimating the formwork area of each element is shown in the Figure 3.29. The general idea of the script is to create a solid with the union of all the elements that comprise the concrete frame of the building, and then isolate the faces that should be covered by forms from the ones that should not. Then the areas of these faces are obtained and stored in the parameter “FORM_Dim_Lateral” if the faces represent the lateral formwork, and in the parameter “FORM_Dim_Bottom” if the faces represent the formwork for the bottom side of the element.

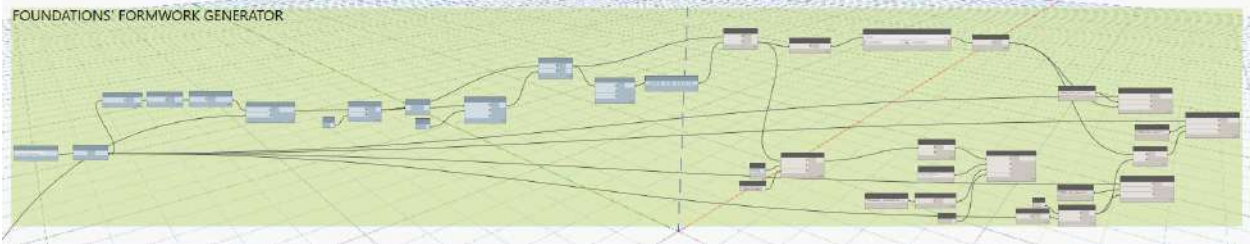


Figure 3.29. Dynamo script for modeling and calculating the formwork area of a foundation.

Figure 3.30 shows an example of a foundation in Dynamo where the blue faces are identified by the Dynamo script as the faces that need to be formed and the black dots are the center point of each face. In Figure 3.32 are shown the results of running the script for modeling formwork surfaces and calculating the formwork area of each element and storing this value it in the corresponding formwork area parameters.

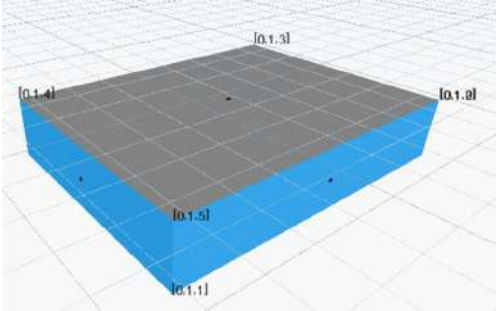


Figure 3.30. Dynamo view of the surfaces that represent the formwork for a foundation.

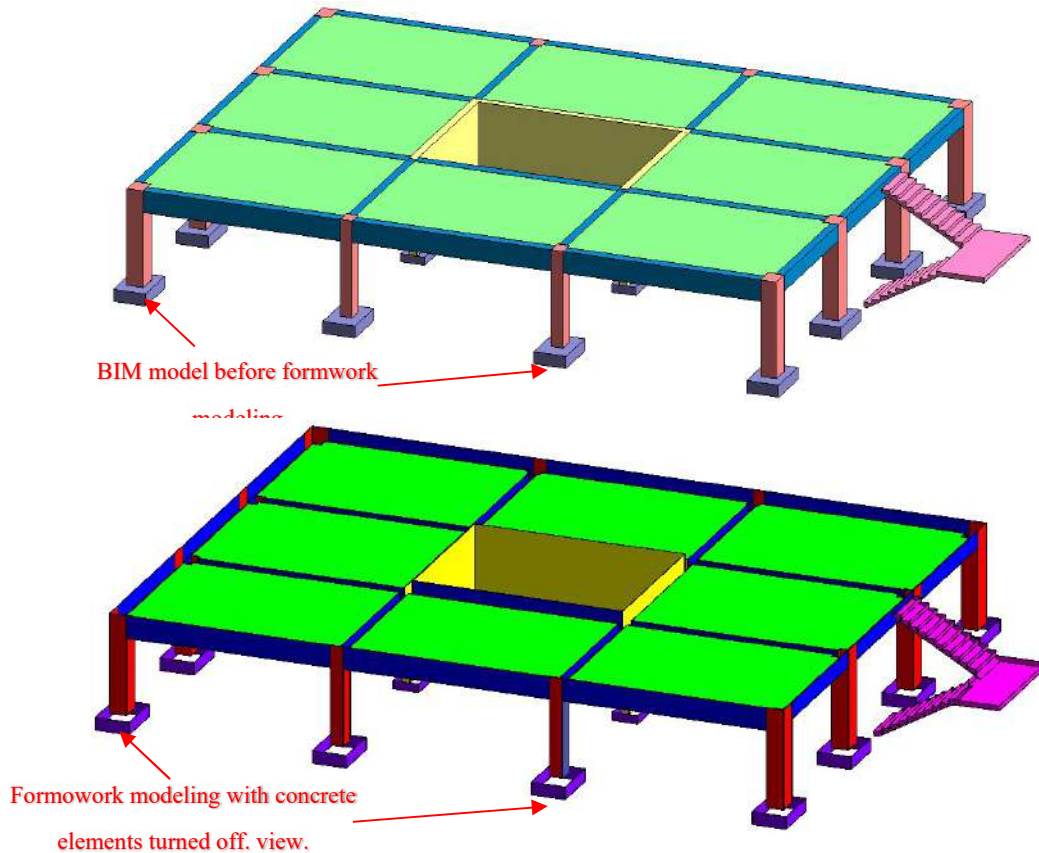


Figure 3.31. Results of running Dynamo script for modeling formworks.

3.7. Populating parameters using Dynamo

Section 3.4 described the process for creating all the “project parameters” in Revit. This section describes the process to enrich these parameters fields with values.

Populating MOD parameters

The MOD parameters do not need any external input, since all the data necessary for populating these parameters is already present in the BIM model as Revit built-in parameters. Figure 3.32 shows the Dynamo script for populating the “MOD parameters” and Figure 3.33 shows the results of running the Dynamo Script.

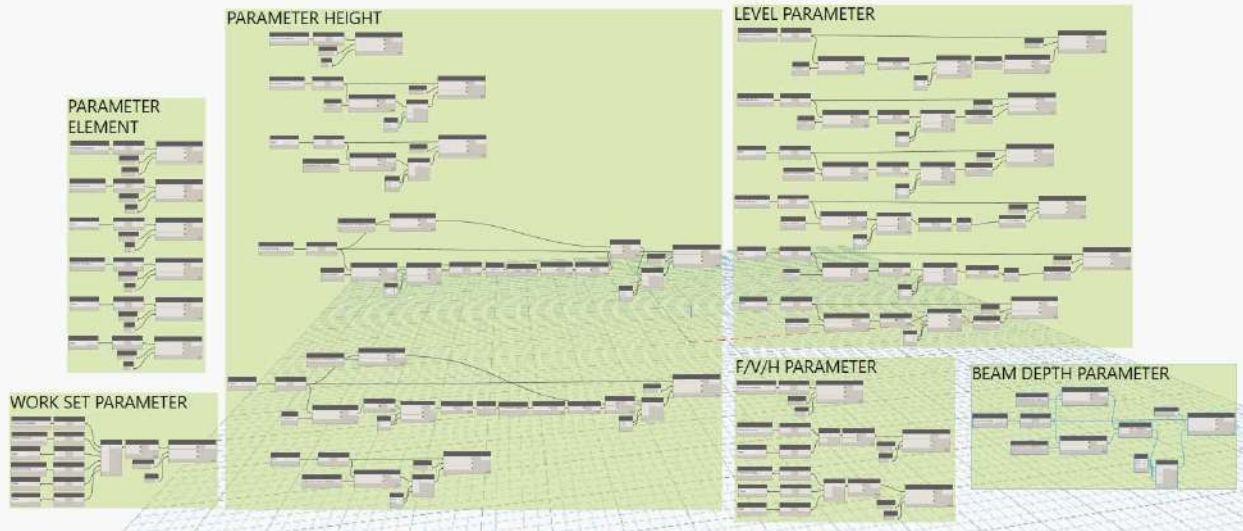


Figure 3.32. Dynamo script for populating MOD parameters

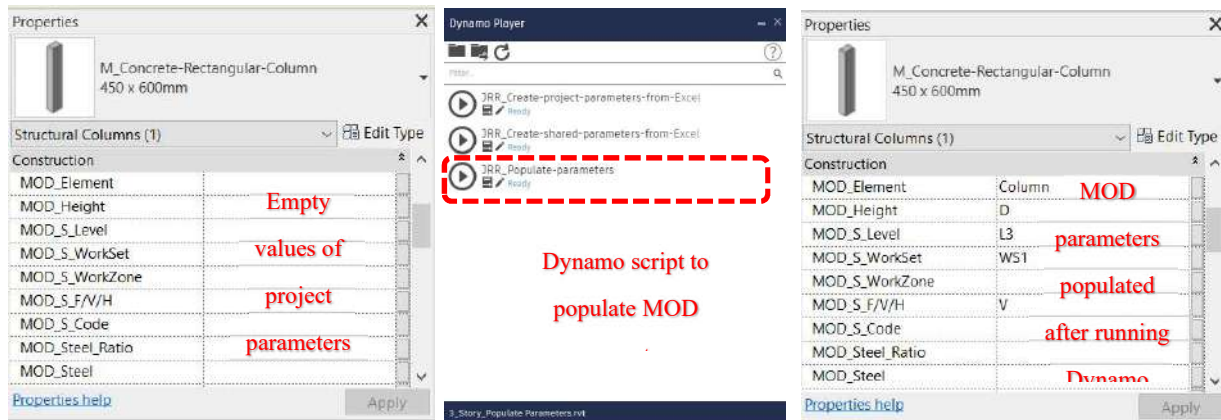


Figure 3.33. Results of running Dynamo script for populating MOD parameters

As shown in Figure 3.33 not all the MOD parameters are populated since the “MOD_S_WorkZone” parameter is filled in using the “JRR_Work_Zoning_Horizontals.dyn”, the “MOD_S_Code” parameter is populated using the “JRR_Import-Dates-from-Excel.dyn” and the “MOD_Steel_Ratio” and “MOD_Steel” parameters are completed using the “JRR_Rates&Ratios_01_Steel.dyn”. Figure 3.34 shows the results after running the scripts for “MOD”, for “TIME” and for “Steel Ratios”. The default reinforcement steel ratios used for this application are shown in Table 3.8, but these values can be customized according to user preferences.

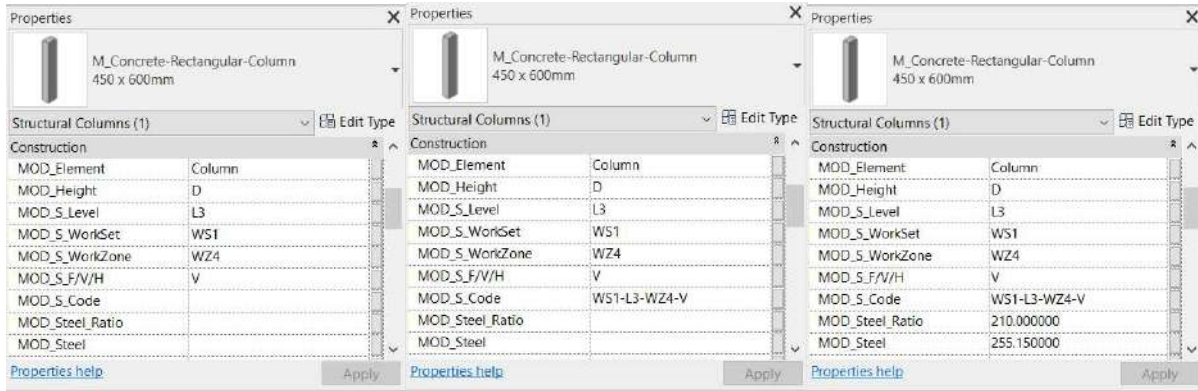


Figure 3.34. Results of running MOD, TIME, and STEEL Dynamos scripts

Table 3.8. Default steel ratios

Code	Description	Ratio	Unit
MOD Steel Ratio	Foundation	60	kg/m3
MOD Steel Ratio	Column	210	kg/m3
MOD Steel Ratio	Wall	190	kg/m3
MOD Steel Ratio	Beam	160	kg/m3
MOD Steel Ratio	Slab	120	kg/m3

Populating TIME parameters

The input for running the Dynamo Script that populates “TIME” parameters is an Excel file that contains all the TIME parameter values and the name of the Excel sheet in this file. Figure 3.34 shows the schedule prepared as an input for calculating the stripping dates for each work zone. These dates can be exported to an Excel file that will be used as an input for the Dynamo script that stores the data in the corresponding “TIME” parameter to enrich the BIM formwork model. Figure 3.35 shows an VBA Excel Macro that is used to automate the generation of the schedule structure. This VBA Excel Macro uses the following data as input: (1) number of stories in the building, (2) number of work zones per level, (3) duration to assemble vertical and horizontal formwork, and (4) durations for concrete elements to gain sufficient strength before forms are stripped.

The VBA Excel Macro will generate the structure of activities that will be used to “copy” and “paste” the values from the Excel Sheet to the MS Project schedule and generate the dates for each work zones as shown in Figure 3.35. Figure 3.35 and Figure 3.36 match perfectly, as can be seen in the first 9 activity lines (first 9 rows in Excel and MS Project), since the VBA Excel Macro

creates the field values for “Task Name”, “Duration”, “Task Calendar”, and “Predecessors” necessary for the MS Project schedule. In the MS Project file, two “calendars” were implemented: (1) “Standard” calendar that only considers working days from Monday to Friday, with exception of holidays, and (2) “Formwork” calendar that considers each day of the calendar as a working day. The reason for having two calendars is that the “Standard” calendar will be assigned for the formwork assembly activities, and the “Formwork” calendar will be assigned for the time concrete needs to gain strength.



Figure 3.35. Schedule generated in MS Project to estimate stripping dates.

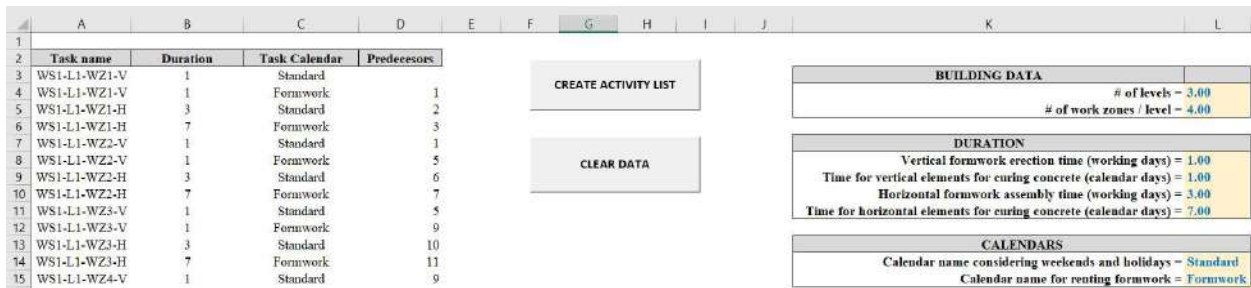


Figure 3.36. VBA Excel Macro for creating Schedule Structure of activities to generate MS project schedule.

Figure 3.37 shows the results of importing the data of the excel file into the Revit “TIME” field parameters. Since Revit does not have a data type for dates, a numeric format is used. For example, in Excel the value “0” is represented as the date “1/1/1900”. So, then the value “44279” shown in Figure 3.37, is equivalent to the date “03/24/2021”. Figure 3.38 shows the Dynamo script for populating “TIME” parameters.

Task Name	Formwork	Shoring	Strip Date
WS1-L1-WZ1-V	2	0	44257.00
WS1-L1-WZ1-H	11	7	44267.00
WS1-L1-WZ2-V	2	0	44258.00
WS1-L1-WZ2-H	13	7	44270.00
WS1-L1-WZ3-V	2	0	44259.00
WS1-L1-WZ3-H	13	7	44271.00
WS1-L1-WZ4-V	2	0	44260.00
WS1-L1-WZ4-H	13	7	44272.00
WS1-L2-WZ1-V	2	0	44261.00
WS1-L2-WZ1-H	10	7	44272.00
WS1-L2-WZ2-V	2	0	44264.00

Figure 3.37 Result of running Dynamo Script for populating dates and time

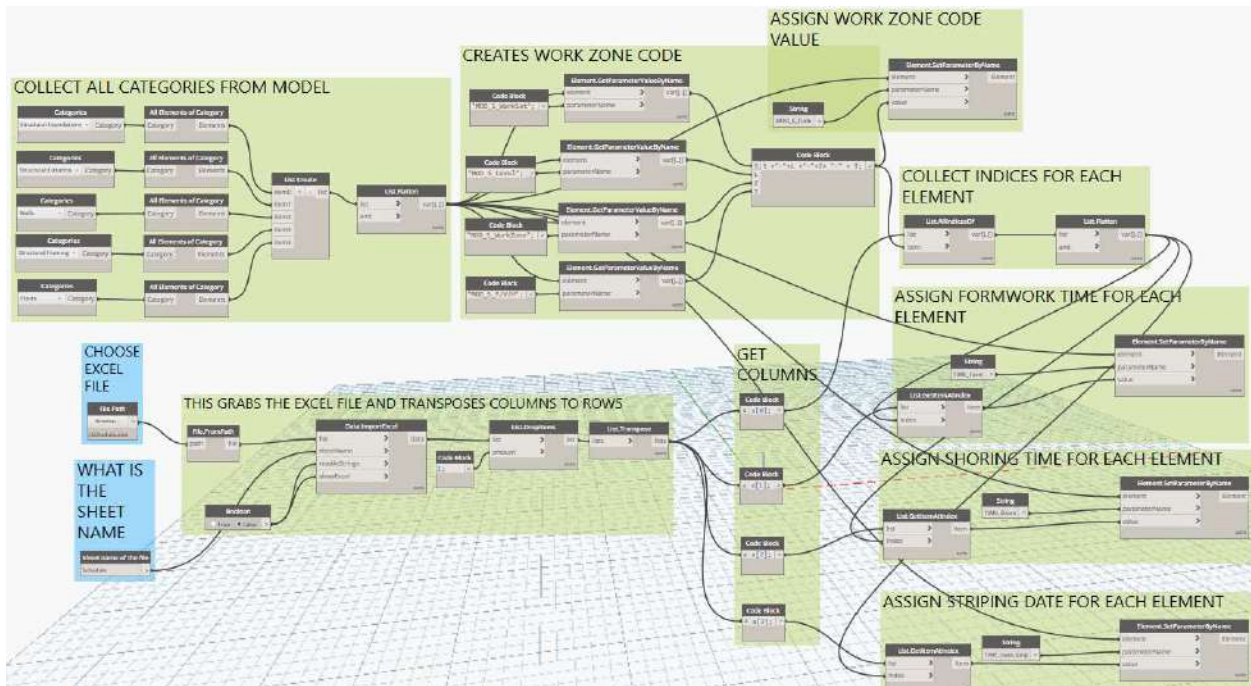


Figure 3.38. Dynamo Script for getting dates and durations.

Populating FORM parameters

FORM parameters are completed using two Dynamo scripts. The first script was described in the section titled “Formwork modeling” section. The second script is used for obtaining the formwork weight ratio (kg/m^2) for each formwork solution from an Excel file source. The results of the Dynamo script for obtaining the formwork weight ratios are shown in Figure 3.39 and the default values for weight ratios of formwork solutions are shown in Table 3.9. Figure 3.40 shows a general view of the Dynamo script for populating the “FORM_Wt” parameters.

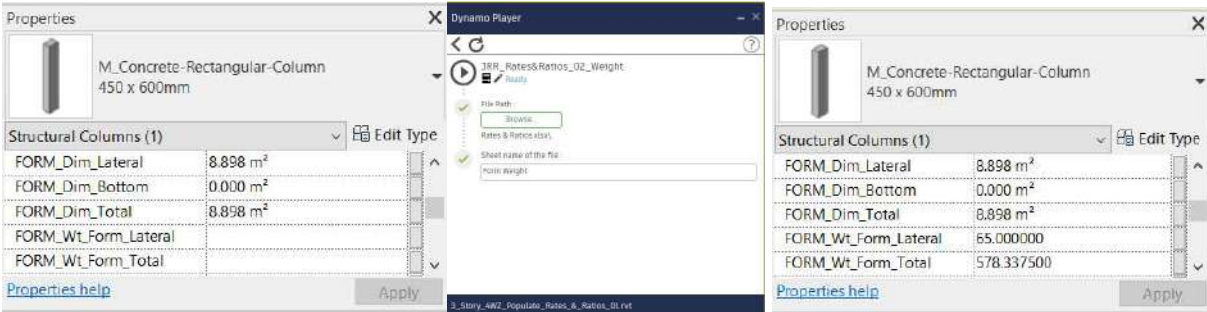


Figure 3.39. Results of running "Weight ratios" script

The “FORM_Wt_Form_Total” is computed using Equation 3.7:

$$FORM_Wt_Form_Total = A + B \quad (3.7)$$

Where:

$$A = (FORM_Dim_Lateral) \times (FORM_Wt_Form_Lateral)$$

$$B = (FORM_Dim_Bottom) \times (FORM_Wt_Form_bottom)$$

Table 3.9. Weight ratios for formwork solutions

CODE	ELEMENT	WEIGHT
FORM Wt Form Lateral	Foundation	100 kg/m ²
FORM Wt Form Lateral	Wall	100 kg/m ²
FORM Wt Form Lateral	Column	65 kg/m ²
FORM Wt Form Bottom	Floor	45 kg/m ²
FORM Wt Shore Bottom	Floor reshoring	10 kg/m ²
FORM Wt Form Lateral	Beam side	70 kg/m ²
FORM Wt Form Linear	Beam support	100 kg/m
FORM Wt Shore Linear	Beam reshoring	50 kg/m

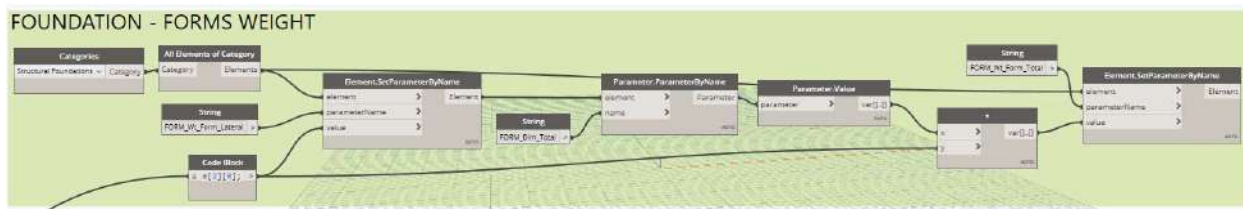


Figure 3.40. Dynamo script for estimating formwork weight for foundations.

Populating PROD parameters

The PROD parameters are populated using an Excel file where all the data of the productivity indexes are stored. The results of running the Dynamo script for filling up the PROD parameters

are shown in Figure 3.41. Figure 3.42 shows a general view of the Dynamo script for populating “PROD” parameters.

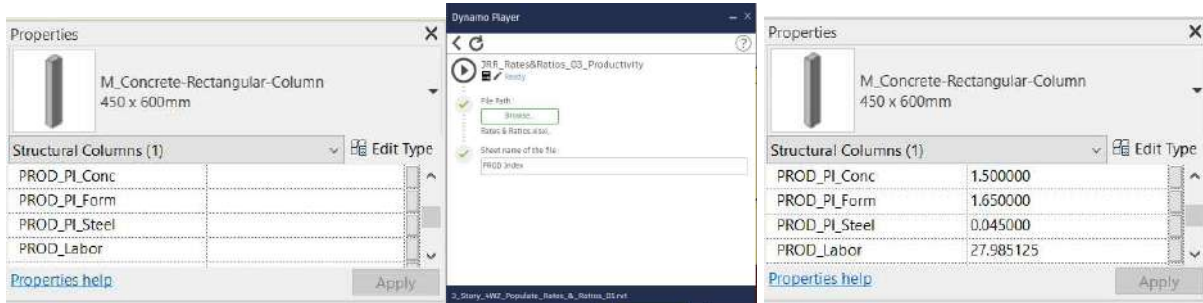


Figure 3.41. Results of running Dynamo script for filling up PROD parameters

The parameter “PROD_Labor” is computed using the Equation 3.8.

$$PROD_Labor = A + B + C \quad (3.8)$$

Where:

A = Volume x PI_Conc x PROD_PI_Conc

B = FORM_Dim_Total x PI_Form x PROD_PI_Form

C = MOD_Steel x PI_Steel = PROD_PI_Steel

The default productivity indexes used for this application are shown in Table 3.10. These values could be customized upon user preferences.

Table 3.10. Productivity indexes references

CODE	Description	Unit	LH/unit
PROD_PI_Conc	Concrete productivity index	m ³	1.50
PROD_PI_Form	Formwork productivity index	m ²	1.65
PROD_PI_Steel	Rebar productivity index	Kg	0.045

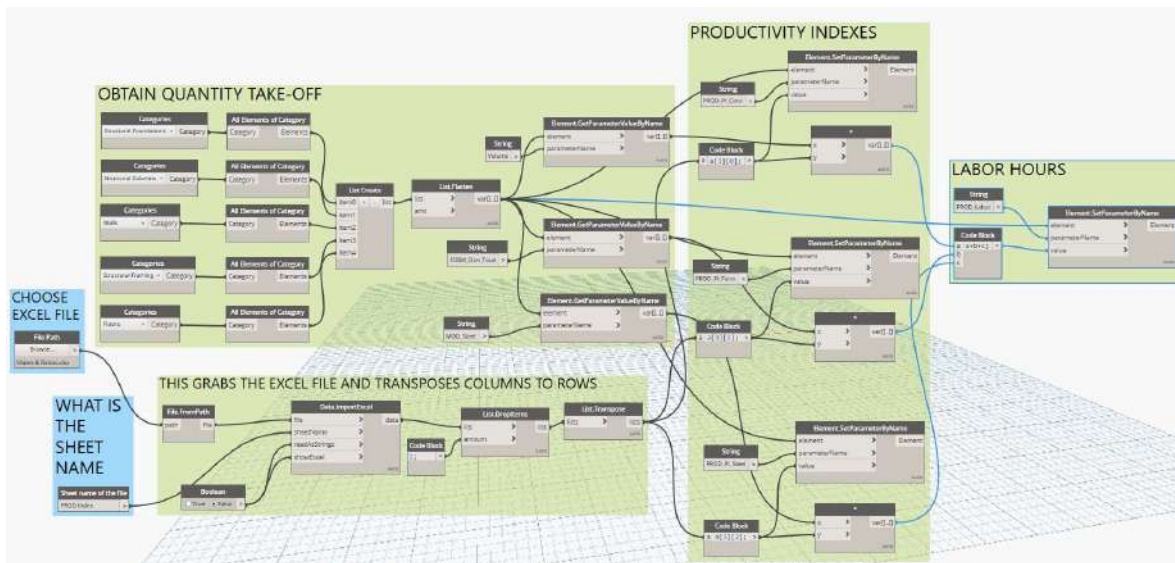


Figure 3.42. Dynamo Script for estimating labor hours.

Populating COST parameters

The last group of parameters are the “COST” parameters which are populated using two Dynamo scripts. The first script fills the parameters related to consumables, and the second one is incorporates the rental rates (\$/m²-day) for each formwork solution and corresponding reshoring system rental rates (\$/m²-day).

The script named “JRR_Rates&Ratios_04_Consumable.dyn” retrieves data from an Excel file where all the ratios for estimating the use of consumables are stored. Table 3.11 shows default ratios of cost for estimating the use of consumables like PVC cones and PVC tubes or other materials that are either used once or have few uses. These values could be customized according to the historical data according to user preferences or formwork providers’ references.

Table 3.11. Referential ratios of cost for estimating consumables.

CODE	Description	Unit	Single use \$/m ²
COST_Rate_Cosum_Single	Wall	m ²	0.13
COST_Rate_Cosum_Single	Column	m ²	0.13
COST_Rate_Cosum_Single	Beam	m ²	0.13

Using the cost ratios and the lateral area, the cost of consumables can be estimated using the Equation 3.9. Figure 3.43 shows the Dynamo Script for estimating formwork consumables cost, and Figure 3.44 the results of using the script for estimating consumables cost.

$$COST_Consumable = COST_Rate_Consumable \times FORM_Dim_Lateral \quad (3.9)$$

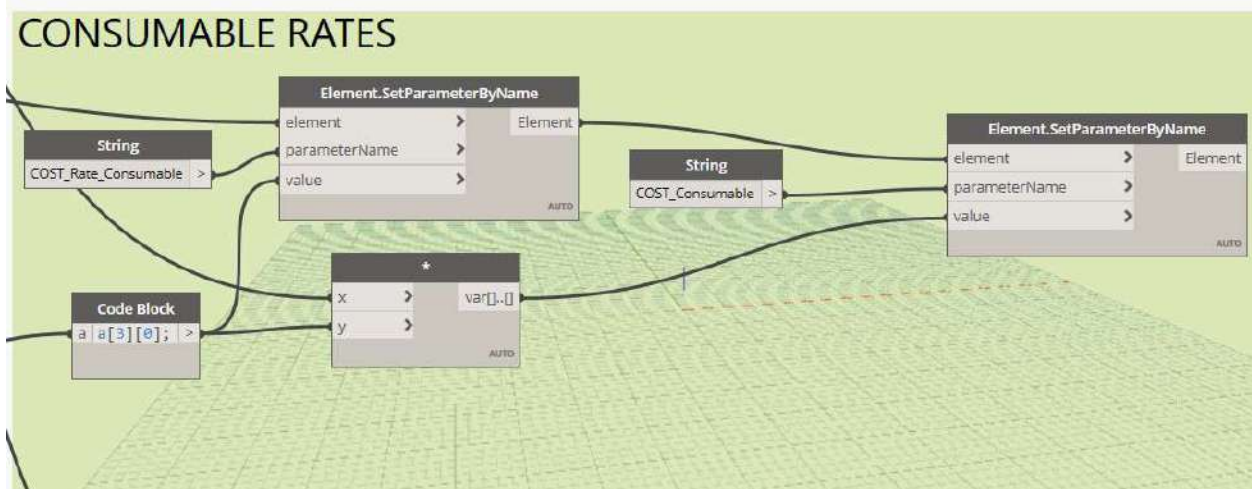


Figure 3.43. Dynamo script for estimating consumable cost.

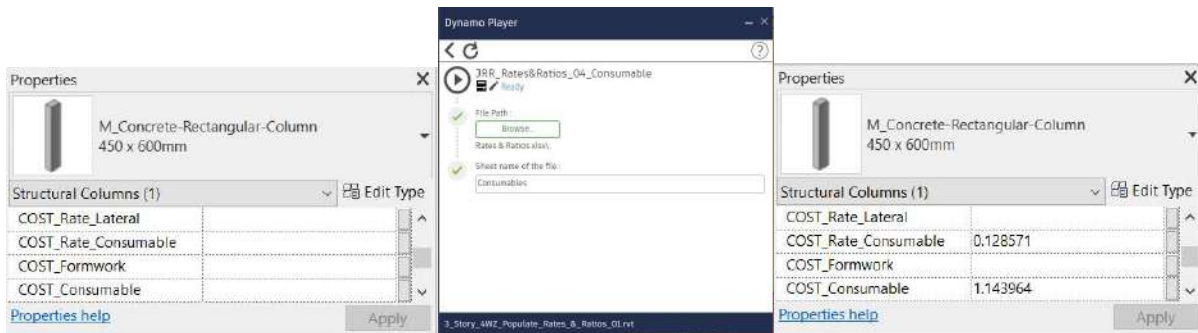


Figure 3.44. Results of running script for estimating formwork consumables cost

The script named “JRR_Rates&Ratios_05_Cost.dyn” retrieves the information regarding the rental cost for different solutions of formwork systems. The coding of rental costs is based on common bidding practices of formwork providers. Table 3.12 and Table 3.13 show the formwork rental costs for several formwork solution systems.

Table 3.12. Rates for renting formwork solution systems

CODE	Description of Solution	Unit.	\$/m2/day S	\$/m2/day D	\$/m2/day T
COST Rate Lateral	Formwork Foundations	m2	0.95	-	-
COST Rate Lateral	Formwork Column	m2	0.57	0.29	0.40
COST Rate Lateral	Formwork Wall	m2	0.57	0.25	0.28
COST Rate Bottom	Slab Bottom - Support	m2	0.03	0.02	0.02
COST Rate Linear	Beam - Support	m	0.53	0.43	0.46
COST Rate Bottom Shore	Slab - Reshoring	m2	0.01	0.01	0.01
COST Rate Linear Shore	Beam - Reshoring	m	0.27	0.21	0.23

Table 3.13. Rates for renting beam lateral formwork solution systems

CODE	Description of Solution	Unit.	\$/m2/day T1	\$/m2/day T2	\$/m2/day T3	\$/m2/day T4
COST Rate Lateral	Formwork Beam	m2	0.28	0.24	0.09	0.05

The total rental cost for formwork equipment can be estimated using Equation 3.10.

$$COST_{Formwork} = C1 + C2 + C3 \quad (3.10)$$

Where:

$$C1 = COST_Rate_Lateral \times FORM_Dim_Lateral$$

$$C2 = COST_Rate_Bottom \times FORM_Dim_Bottom$$

$$C3 = COST_Rate_Linear \times FORM_Dim_Linear$$

The total renting cost for the re-shoring equipment can be estimated similarly using Equation 3.11.

$$COST_{Shoring} = C1 + C2 + C3 \quad (3.11)$$

Where:

$$C2 = COST_Rate_Bottom_Shore \times FORM_Dim_Bottom$$

$$C3 = COST_Rate_Linear_Shore \times FORM_Dim_Linear$$

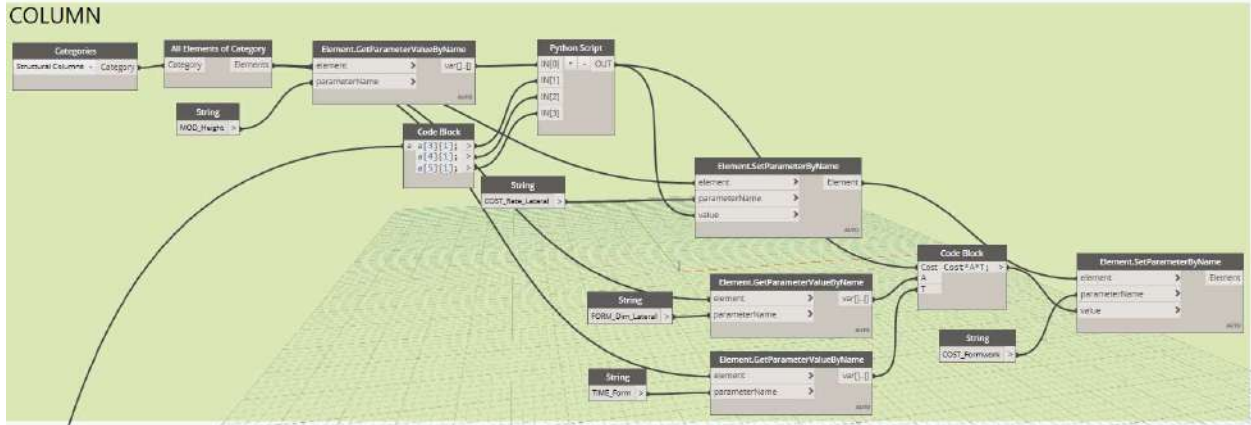


Figure 3.45. Dynamo Script for estimating renting cost of column formwork.

The results of running the Dynamo Script named “JRR_Rates&Ratios_05_Cost.dyn” are shown in Figure 3.46.

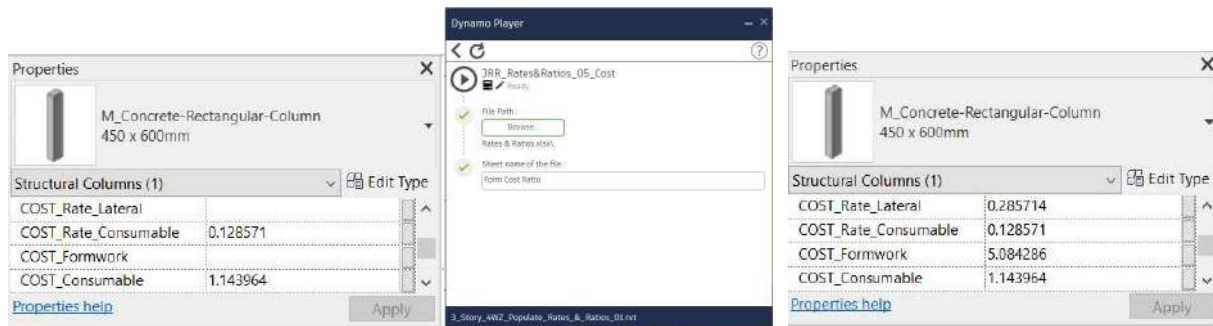


Figure 3.46. Results of running script for estimating formworks renting costs

Summary

A summary workflow is presented in Figure 3.47 to highlight the sequence of using different Dynamo scripts, Excel files and MS Project files developed for this thesis. Each box groups a set of tools with a common process. These boxes represent processes in the BIM-based tool that have been described in this chapter. An image of the result using a 3-story building sample is shown at the end of the workflow. All blocks are interconnected with arrows that represent the flow in which each tool has to be executed.

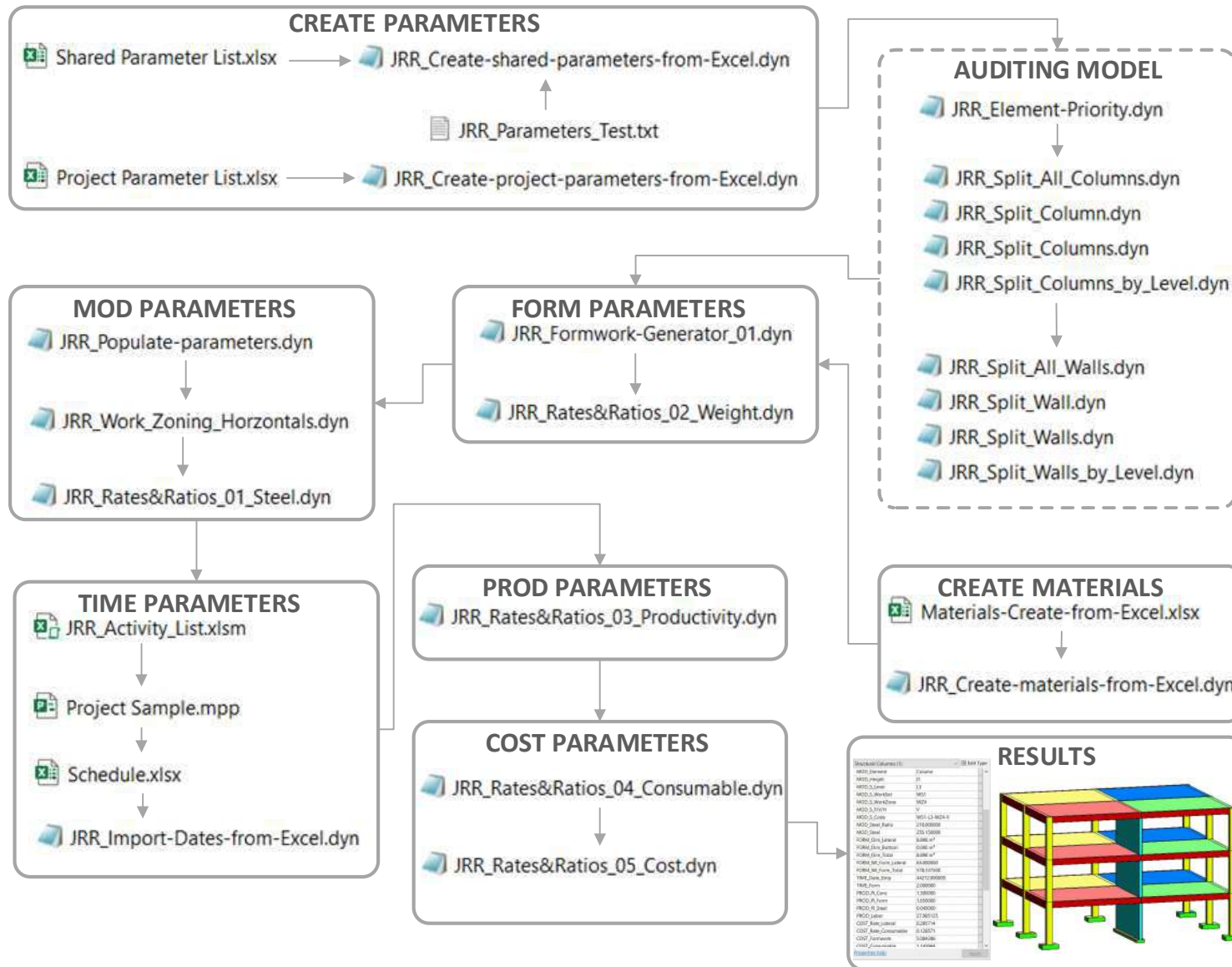


Figure 3.47. Flowchart for using Dynamo Scripts and Excel files

4. EVALUATION OF THE FORMWORK MANAGEMENT TOOL

Chapter 3 described the first phase of the BIM-based formwork management tool, and focused on BIM formwork modeling and enrichment with formwork related data of the BIM model. Chapter 4 describes the second phase for the use of the BIM-based formwork management tool, which is the utilization of the BIM model generated during first phase, for multiple cost and time analyses. The cost and time analyses include: (1) the computation of quantities of rebar, formwork, and concrete, (2) the formwork cost analysis which involve the estimation of the average formwork unit cost including cost of labor, formwork rental, plywood, consumables, and freights, (3) the computation of other formwork KPIs like rotation factor and formwork efficiency, (4) the formwork demand profile that will allow the user to estimate how much formwork should be delivered to the jobsite, and (5) the generation of color coded layouts for multiple purposes like tracking formwork removal dates and work zoning. At the end of this chapter, two case studies are presented and the results of using the two-phase implementation BIM tool are explained.

4.2. Roadmap for using the BIM-based formwork management tool.

Chapter 3 focused on the first phase of the BIM-based formwork management tool, which involves the development of a BIM model that is enriched with geometric (height, depth, volume, area, etc.) and non-geometric (weight, cost, productivity, installation time, etc.) data related to formwork. Chapter 4 covers the second phase of this tool and focuses on how the BIM model developed in the first phase can be used for formwork management. Figure 4.1 shows a roadmap for the implementation of the six steps used in phase 2. Each column in this figure represents one step that could be implemented using the BIM model as the unique input. Each process has a different output and not necessarily every process needs to be implemented, also every column is independent of the others, so their sequence does not represent the order for application. Implementation of each of the processes will depend on the user's requirements. At bottom of each column of the roadmap the main purpose for each process (controlling, planning, benchmarking, procurement, preconstruction, and tracking) is defined. The heading of each column in the roadmap is related to a specific section in this chapter where the process is fully detailed. For implementation of the second phase of the BIM-based formwork management tool, different

software packages and specific tools are required. These software packages and tools are represented with an icon next to box that represent each input, process, or output in the roadmap. For better understanding a legend describes the icons at the bottom of Figure 4.1.

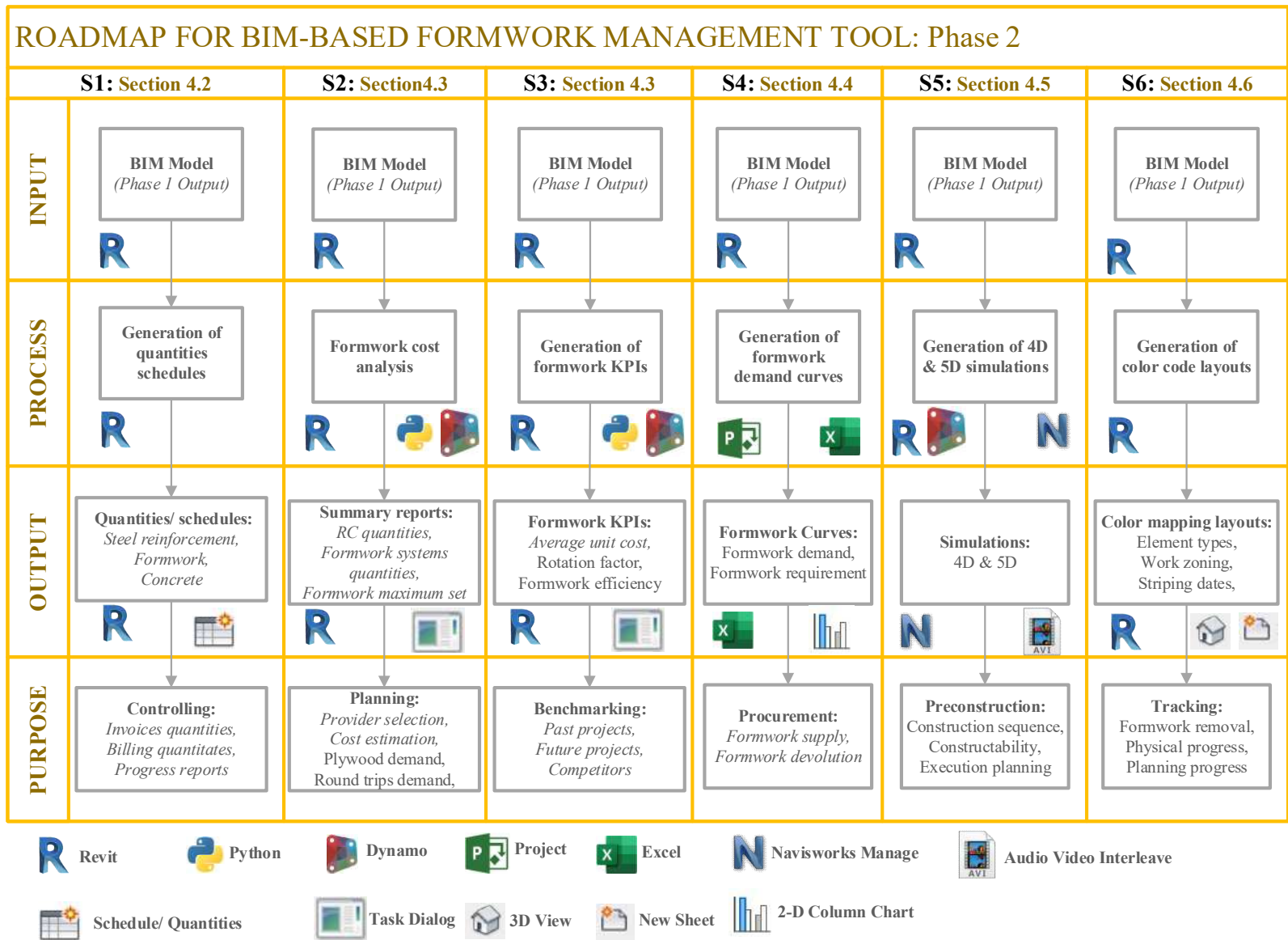


Figure 4.1. Roadmap for second phase of the BIM-based formwork management tool

4.3. Generation of schedules and quantities

According to (Autodesk Help, 2021), a schedule in Revit is a tabular representation that displays any type of element in a BIM model and list all the instances of the type of element selected or grouped instances based on a designated criterion. Two types of schedules are commonly used for preparing a quantity takeoff summary: “quantities schedule”, and “material takeoff schedule”. Quantities schedules and material takeoff schedules for formwork systems can be used for reviewing the quantities of the invoices presented by a subcontractor or by the formwork supplier. Also, these schedules can be used for preparing the billing quantities that will be presented to the owner, and for generating progress reports related to formwork.

Quantities schedule

This type of schedule is recommended when there is no need to consolidate all element types in a single table. In this type of schedules, the user can select multiple categories (“Multi-Category”) for a single table, but only if the category is a “family type” component. Of all the structural elements, “Structural Foundations”, “Structural Columns”, and “Structural Framing” are considered “family type” components. In contrast, “Walls” and “Floors” are considered “host” components and cannot be combined with “family type” components in the same table. Figure 4.2 shows the “Multi-Category” selection option for a new schedule, and Figure 4.3 shows the results of applying this “Multi-Category” selection option. The quantities schedule for “Floors” and “Walls” must be generated separately. An alternative option is converting all the elements (family and host components) into “Parts” like the process described in Section 3.5 for work zone leveling.

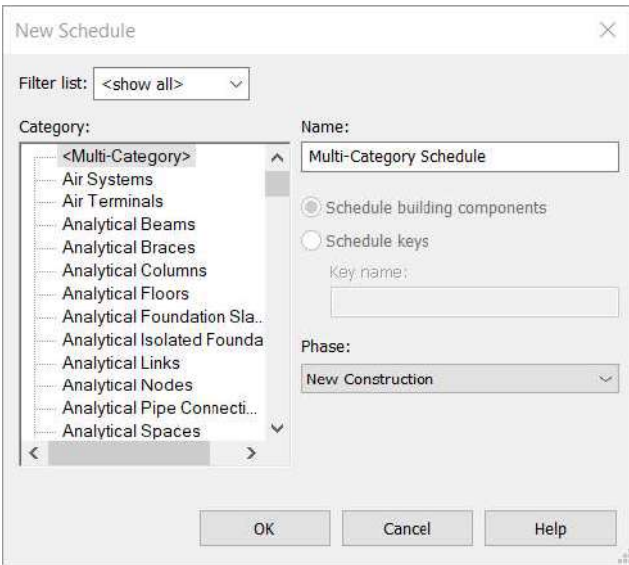


Figure 4.2. Multi-Category option for creating a new quantities list/schedule

<Formwork summary>					
A	B	C	D	E	F
Work Zone Code	Element Type	Height Type	Bottom Area	Lateral Area	Total Area
WS1-L1-W21-F	Foundation	S	0.00 m²	5.40 m²	5.40 m²
WS1-L1-W21-H	Beam	D	8.76 m²	24.22 m²	32.97 m²
WS1-L1-W21-V	Column	D	0.00 m²	17.42 m²	17.42 m²
WS1-L1-W22-F	Foundation	S	0.00 m²	10.74 m²	10.74 m²
WS1-L1-W22-H	Beam	D	8.76 m²	24.22 m²	32.97 m²
WS1-L1-W22-V	Column	D	0.00 m²	17.42 m²	17.42 m²
WS1-L1-W23-F	Foundation	S	0.00 m²	2.70 m²	2.70 m²
WS1-L1-W23-H	Beam	D	5.84 m²	18.28 m²	24.12 m²
WS1-L1-W23-V	Column	D	0.00 m²	8.93 m²	8.93 m²
WS1-L1-W24-F	Foundation	S	0.00 m²	5.40 m²	5.40 m²
WS1-L1-W24-H	Beam	D	8.97 m²	26.04 m²	35.01 m²
WS1-L1-W24-V	Column	D	0.00 m²	17.59 m²	17.59 m²
WS1-L2-W21-H	Beam	D	8.76 m²	24.22 m²	32.97 m²
WS1-L2-W21-V	Column	D	0.00 m²	17.42 m²	17.42 m²
WS1-L2-W22-H	Beam	D	8.76 m²	24.22 m²	32.97 m²
WS1-L2-W22-V	Column	D	0.00 m²	17.42 m²	17.42 m²
WS1-L2-W23-H	Beam	D	5.84 m²	18.28 m²	24.12 m²
WS1-L2-W23-V	Column	D	0.00 m²	8.93 m²	8.93 m²
WS1-L2-W24-H	Beam	D	8.97 m²	26.04 m²	35.01 m²
WS1-L2-W24-V	Column	D	0.00 m²	17.59 m²	17.59 m²
WS1-L3-W21-H	Beam	D	8.76 m²	24.22 m²	32.97 m²
WS1-L3-W21-V	Column	D	0.00 m²	17.42 m²	17.42 m²
WS1-L3-W22-H	Beam	D	8.76 m²	24.22 m²	32.97 m²
WS1-L3-W22-V	Column	D	0.00 m²	17.42 m²	17.42 m²
WS1-L3-W23-H	Beam	D	5.84 m²	18.28 m²	24.12 m²
WS1-L3-W23-V	Column	D	0.00 m²	8.93 m²	8.93 m²
WS1-L3-W24-H	Beam	D	8.97 m²	26.04 m²	35.01 m²
WS1-L3-W24-V	Column	D	0.00 m²	17.59 m²	17.59 m²

Figure 4.3. Result of creating a Multi-Category schedule

Materials takeoff schedule

An option for creating a single summary table that contains all formwork solution systems (family components and host components) is using the “materials takeoff schedule” option. Figure 4.4 shows how to create a “New Material Takeoff” schedule using the category “Generic Models”. Formwork were modeled using a Dynamo Script in Chapter 3, using the category “Generic Models” for “direct modeling” by thickening the faces of the solid that represent a formwork contact area. To differentiate between formwork solution system in the “materials takeoff schedule”, each formwork solution system has a different “material” property in Revit. Since each formwork solution system was modeled considering a different “material” property, a summary breakdown table can be generated using the “material takeoff schedule” tool. Figure 4.5 shows the results of generating a “material takeoff schedule” considering as fields for the table the “Material: name” and the “Material: area”.

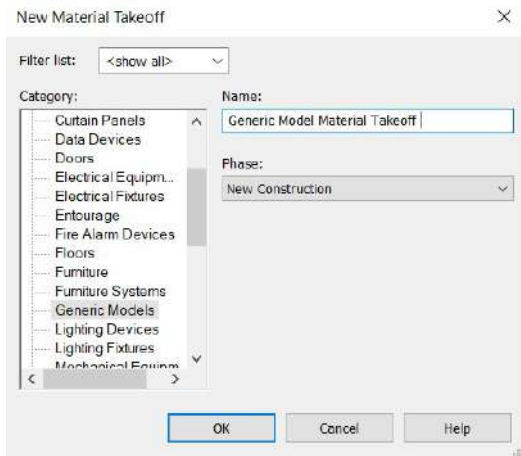


Figure 4.4. Creating a New Material Takeoff schedule

<Generic Model Material Takeoff>	
A	B
Material: Name	Material: Area
Formwork_Beam	777.60 m ²
Formwork_Column	381.40 m ²
Formwork_Foundation	50.69 m ²
Formwork_Slab	1784.96 m ²
Formwork_Wall	418.37 m ²

Figure 4.5. Results of creating a New Material Takeoff schedule

4.4. Formwork cost analysis & KPIs

Formwork planning may include: (1) selecting the formwork provider, (2) estimating the formwork cost for bidding, (3) estimating the quantity of plywood sheets that will be required for executing the project, (4) estimating the number of trucks that will be necessary for transporting all the formwork components to the jobsite and back to the supplier warehouse, and (5) computing formwork KPIs for benchmarking. Since the BIM model is available from the first phase of the BIM-based formwork management tool, the following summaries can be generated automatically using Dynamo scripts: (1) quantities takeoff summary, (2) quantities takeoff summary for every formwork solution system, (3) maximum set size for every formwork solution system, and (4) formwork management KPIs (rotation factor and formwork efficiency).

4.4.1. Quantities takeoff summary for RC structure components

RC structures have three main components: (1) steel reinforcement, (2) formwork, and (3) concrete. Since steel reinforcement is not modeled in the BIM model, the approximate quantity of steel reinforcement can be determined by using ratios based on the concrete volume. The steel reinforcement quantity was included as a numeric parameter named “MOD_Steel” in the BIM model, so the total quantity of rebar can be computed by adding the value of every element for the “MOD Steel” parameter. Similarly, the total formwork area can be determined by adding the value of every element for the parameter named “FORM_Dim_Total”. Likewise, the overall sum of the values of the parameter “Volume” for all the elements in the model will represent the total concrete

volume in the project, and the total amount of labor hours can be computed using the overall sum of the value of the parameter “PROD_Labor” for every element in the model.

A Dynamo script named “JRR_01_QTO_Summary.dyn” was developed for automating the computation of this summary of quantities for the entire project. Figure 4.6 shows the workflow of this Dynamo script. The script is used to select all RC elements, create a list with these elements, obtain the parameter values of the elements in the list regarding three parameters (Volume, FORM_Dim_Total, and MOD_Steel), then separate all these values into three sub lists (one list for Volume, one for FORM_Dim_total, and one for MOD_Steel), and then add the values in each sub list. The results are then presented in a “Task Dialog” window using a python script node. Figure 4.7 presents the results of running the Dynamo script for determining the quantities takeoff summary for the entire project.

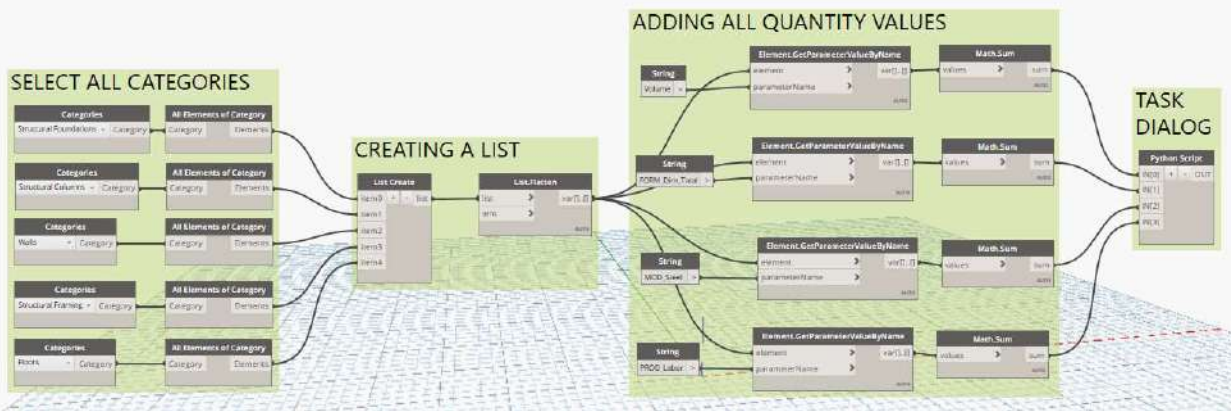


Figure 4.6. Dynamo script for computing quantities summary for entire project



Figure 4.7. Results of running Dynamo script for computing quantities summary.

4.4.2. Quantities takeoff summary for formwork solution systems

A quantity takeoff summary requires a breakdown structure to differentiate the formwork quantities by formwork solution system (column formwork, beam support, beam formwork sides, etc.) that are considered in the project. The summary discussed in Section 4.3.1 considers formwork area as a single value, so a new summary is required to consider a quantity takeoff breakdown structure that differentiates formwork areas by solution system: foundations area, columns area, walls area, beam lateral sides area, beam bottom area, beam support length, and slabs bottom area.

A Dynamo script named “JRR_02_Formwork_Summary.dyn” was developed for automating the generation of the summary of formwork quantities considering the breakdown by formwork solution system types. The Dynamo script also computes: (1) the total formwork area, (2) the total formwork rental cost, (3) the total reshoring system rental cost, and (4) the total cost of consumables, and the total labor cost required for forming and reshoring the entire project. Figure 4.8 shows the Dynamo script for creating the formwork areas in a breakdown summary. The general workflow of this script consists of getting the overall sum for each value desired and then use a task dialog for presenting all the results computed. Figure 4.9 shows the results of running the Dynamo script for computing the formwork summary. The summary appears in a “Task Dialog” window but with few changes in the Dynamo script, the result could be instead exported to an Excel file for better presentation and more easily access of the data for other calculations that the user may require.

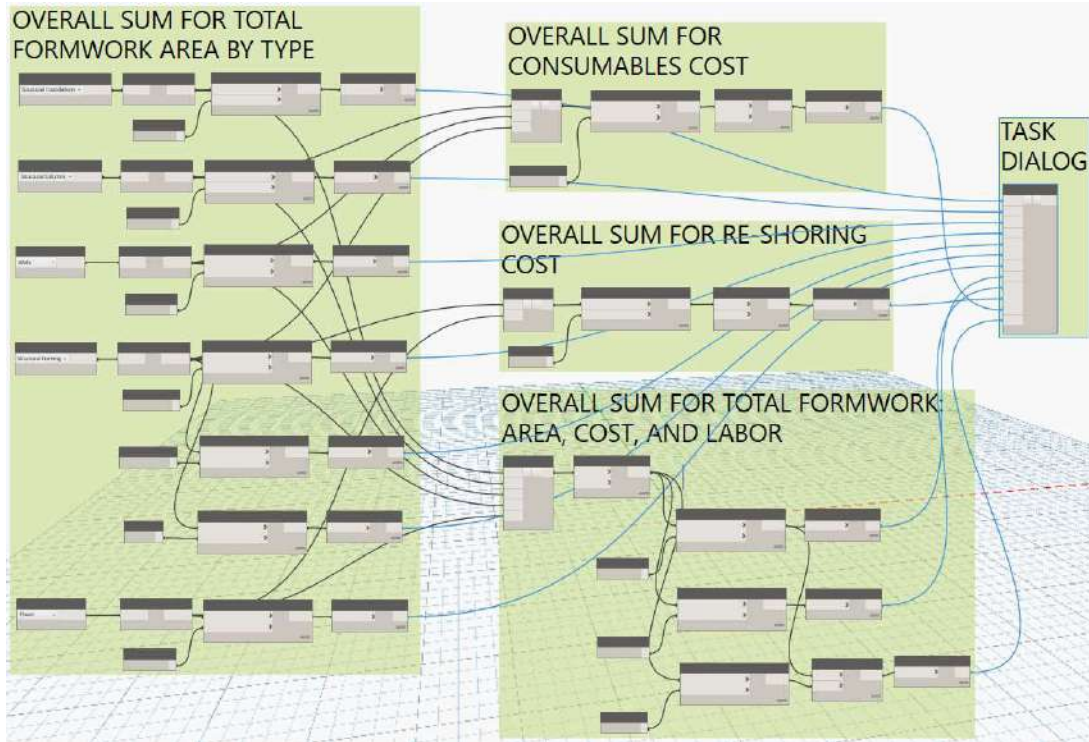


Figure 4.8. Dynamo script for generating formwork summary.



Figure 4.9. Results of running Dynamo script for formwork summary.

4.4.3. Maximum formwork set size by formwork solution system.

The maximum formwork set represents the total formwork required for executing a project considering a reuse scheme. The maximum formwork set size depends on the number of sets required for forming or shoring the structure and the area that each set can cover. The number of sets is defined by the number of days that a set is used for forming or shoring a single work zone before being used in the next work zone available. A simple example of this process would be the

case of a perimeter concrete wall of 100m length and 3m height, that is planned to be executed in 10 equal work zones of 10m length each one. If the time for setting the formwork is 0.5 days, the time for supporting the placed concrete until the formwork is stripped is 1 day and the time for stripping the forms is 0.5 days, then the total time that a formwork set will be used for one single work zone will be 2 days. If we consider a single production set, and a single forming crew then the total number of sets that are required to maintain the construction flow is 2 sets. Since each work zone is 10m in length, the formwork area of each work zone will be 60m^2 , if both faces of the wall are formed. Equation 4.1 is used to compute the maximum formwork set size for the example described.

$$\text{Maximum formwork set size} = (\text{Workzone formwork area}) \times (\text{Number of Sets}) \quad (4.1)$$

$$\text{Maximum formwork set size} = (60\text{m}^2) \times (2) = 120\text{m}^2$$

In construction projects it is common to have different formwork areas for each work zone. In such cases, Eqn. 4.1 no longer provides an accurate way to estimate the maximum formwork set size. Figure 4.10 presents an example for building foundations of different sizes where each work zone has a different total formwork area. The right side of Figure 4.1 shows the total formwork area required for each work zone, and the left side shows the plan view and a 3D view of the foundations color coded with a different color for each work zone. In this example, 15 work zones are considered, and the number of foundations is variable for each work zone. The construction sequence is established according to the labeling of the work zones. If all forms used in a work zone will be reused every two days (one day for assembly and one day that the form stays in place while the placed concrete gains adequate strength), then the maximum formwork set size will be established by the maximum sum of the formwork area of the two largest consecutive work zones. In the example, pairing the work zones in groups of two consecutive work zones, the maximum formwork area is reached in the pair comprising WZ7 and WZ8, so then the maximum formwork set size would be 57 m^2 .

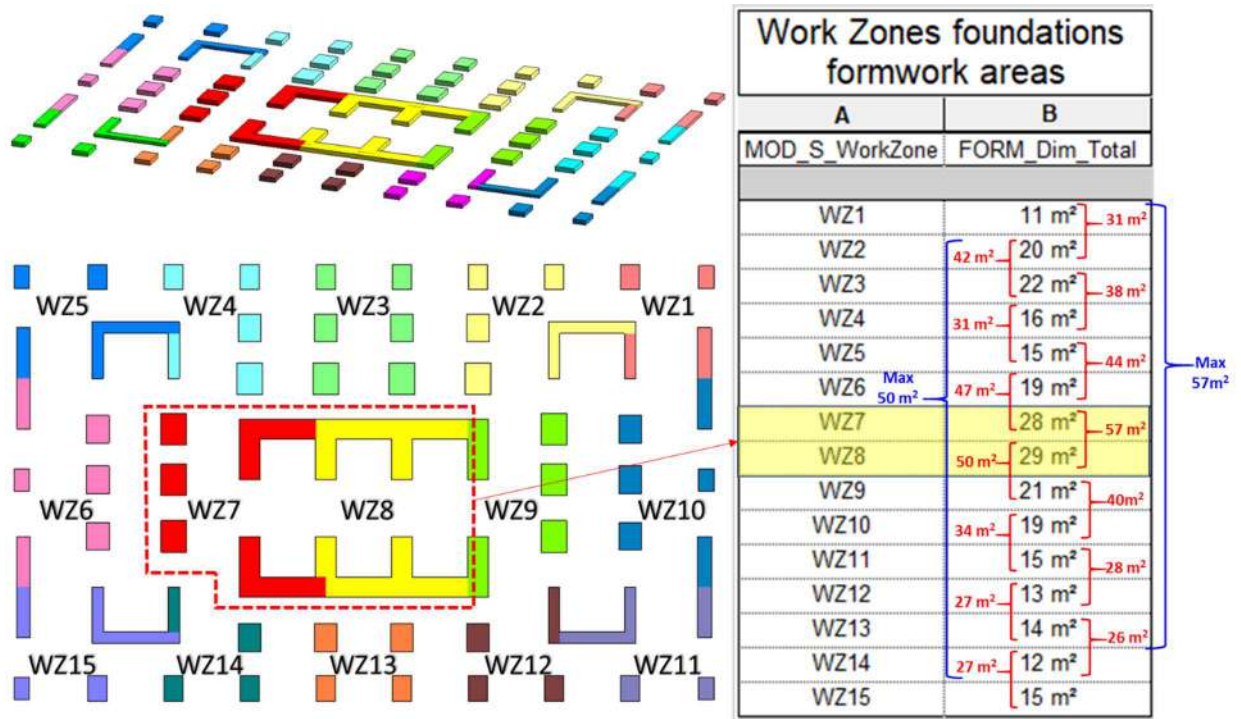


Figure 4.10. Analysis for computing foundations maximum formwork set size.

A Dynamo script named “JRR_03_Maximum_Formwork_Set.dyn” was developed for calculating the maximum formwork set size for every formwork solution system. Figure 4.11 shows a blow-up detail for the maximum set workflow for the formwork foundation from the Dynamo script previously mentioned. The first step in the Dynamo workflow consists of determining the total number of work zones (N_Zones) in the project, the number of sets (N_Sets) for the specific formwork type, and the formwork area for each foundation in each work zone across the entire building. The second step of the Dynamo Script uses these values as inputs to run a Python Script node to calculate the maximum formwork set for this formwork type.

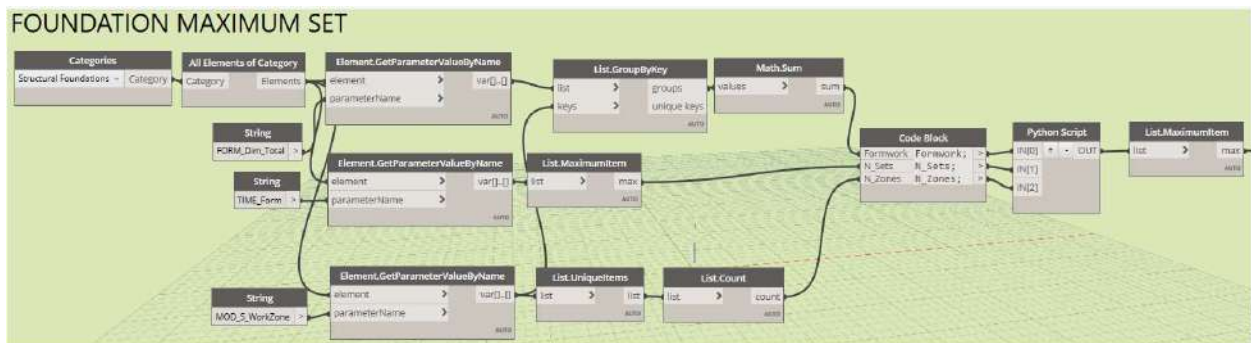


Figure 4.11. Dynamo script for computing the maximum formwork set size for foundations.

Figure 4.12 shows an example of how the estimation of maximum set size of formwork can be done manually using Revit. In the example, the formwork area for WZ1 and WZ2 added together provide the maximum formwork area required for building the foundations considering the reuse scheme described earlier in this section.

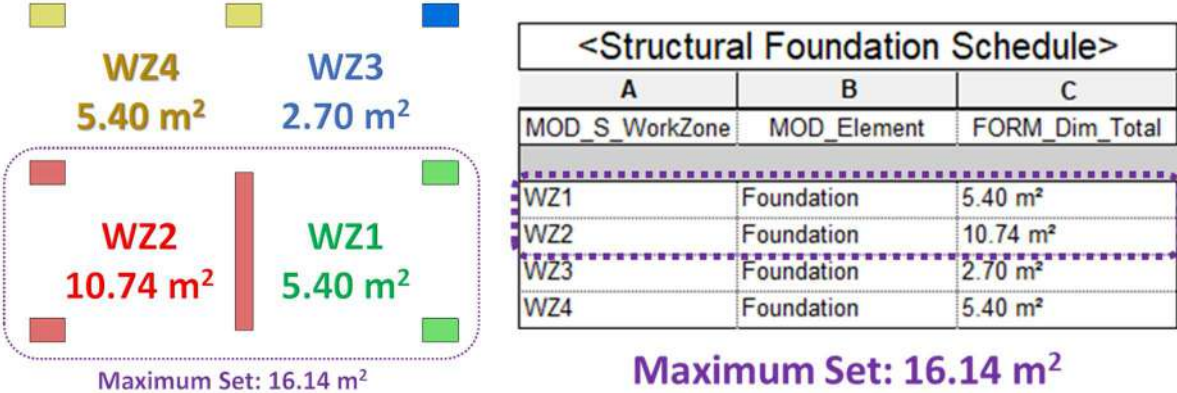


Figure 4.12. Maximum formwork set size for foundations

Figure 4.13 shows the results of running the script “JRR_03_Maximum_Formwork_Set.dyn”. The Dynamo script computes the maximum formwork set size for every solution system (Foundation, Column, Wall, Beam bottom, Beam side, Beam support, Beam re-shore, Slab, and Slab re-shore). The script also computes the total amount of plywood required as sheathing faces in slabs and beams. An additional feature of this Dynamo tool is that the script can compute the total weight of formwork equipment which provides the input for estimating the number of trucks required for transporting all the formwork sets.

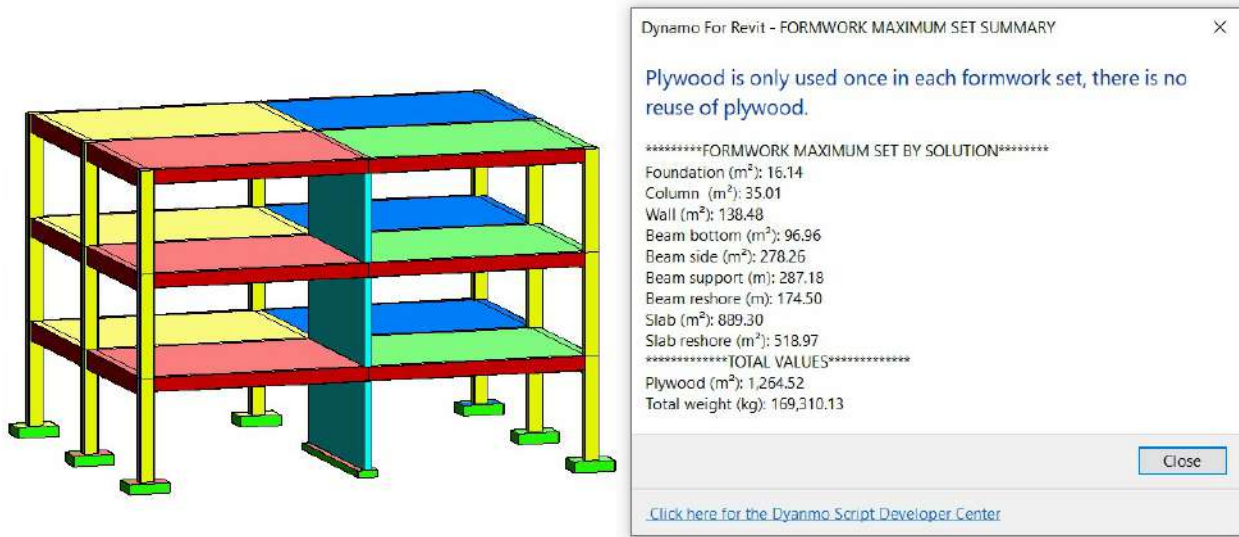


Figure 4.13. Results of running Dynamo script for computing maximum formwork set size.

4.4.4. Formwork management KPIs

Key Performance Indicators (KPIs) are measurable values that represent the performance regarding a pre-established objective. In case of formwork management there are three main KPIs that could be considered for benchmarking and for controlling formwork performance: (1) formwork overall unit cost or cost ratio, (2) formwork rotation or reuse factor, and (3) formwork efficiency. These three KPIs were explained in Chapter 2, but the implementation using Revit is described in this section.

Formwork Overall Unit Cost or Cost Ratio (CR)

“CR” is the ratio of the total formwork cost (expressed in dollars) to the total formwork area (expressed in square meters) in the project. The total formwork cost is estimated using Equation 4.2.

$$Totalformworkcost = C_1 + C_2 + C_3 + C_4 + C_5 + C_6 \quad (4.2)$$

Where:

$$C_1 = Formwork\ rental\ cost = \sum COST_Formwork$$

$$C_2 = Reshoring\ rental\ cost = \sum COST_Shoring$$

$$C_3 = Labor\ Cost = \left(\sum FORM_Dim_Total \right) x (PROD_PI_Form) x (Labor\ Cost\ Rate)$$

$$C_4 = \text{Consumables Cost} = \sum \text{COST_Consumable}$$

$$C_5 = \text{Plywood Cost} = (\text{Freight Rate}) \times \left(\sum_{i=1}^8 W_i \right) / \text{Truck payload capacity (kg)}$$

$W_1 = \text{Maximum Formwork Set Weight for foundations}$

$W_2 = \text{Maximum Formwork Set Weight for columns}$

$W_3 = \text{Maximum Formwork Set Weight for walls}$

$W_4 = \text{Maximum Formwork Set Weight for beam side}$

$W_5 = \text{Maximum Formwork Set Weight for beam support}$

$W_6 = \text{Maximum Formwork Set Weight for beam re – shore}$

$W_7 = \text{Maximum Formwork Set Weight for slab support}$

$W_8 = \text{Maximum Formwork Set Weight for slab re – shore}$

$$C_6 = \text{Plywood Cost} = (\text{Plywood unit cost}) \times (M_1 + M_2 + M_3 + M_4 + M_5)$$

$M_1 = \text{Maximum Formwork Set – Slab}$

$M_2 = \text{Maximum Formwork Set – Beam side}$

$M_3 = \text{Maximum Formwork Set – Beam bottom}$

$M_4 = \text{Maximum Formwork Set – Column Joint}$

$M_5 = \text{Maximum Formwork Set – Wall Joint}$

“CR” has two inputs: (1) the “Total Formwork Cost” value as numerator, and (2) the “Total Formwork Area” value as denominator and can be computed using Equation 4.3.

$$CR = \frac{\text{Total Formwork Cost (USD\$)}}{\text{Total Formwork Area (m}^2\text{)}} \quad (4.3)$$

Reuse Factor (RF)

In general, formwork for vertical elements like columns and walls have a higher “Reuse Factor” RF than the Reuse Factor for formwork horizontal elements since vertical formwork are attached to concrete for very short time (commonly between one and two days). Formwork for horizontal elements like slabs and beams normally stays in place for longer times (commonly between 4 and 7 days). Then “Reuse Factor” must be computed separately for vertical elements and for horizontal elements. Formwork “Reuse Factor” (RF) for vertical and horizontal elements can be computed using Revit since all the data necessary for computation is already in the BIM model. In this case the Dynamo script developed is only computing the RF for horizontal elements since is these

elements have lower rotation. RF in general for vertical or horizontal elements can be estimated using Equation 4.4.

$$RF = \frac{\textit{Total Number of Work Zones}}{\textit{Total Number of Horizontal Formwork Sets}} \geq 1 \quad (4.4)$$

If the RF value is close to “1” it implies that formwork is not adequately reused and indicates either that better planning of formwork use is required, or the features of the building do not facilitate formwork reuse.

Formwork Efficiency (FE)

Since the “Reuse Factor” RF does not consider the vertical elements in the assessment of formwork management, another approach to estimate the formwork performance is “Formwork Efficiency” (FE). FE can be computed using Equation 4.5, that has as input values the “Formwork Maximum Set Size” expressed in square meters and the “Total Formwork Area” also expressed in square meters.

$$FE = \frac{\textit{Total formwork area}}{\textit{Total area of the formwork maximum set}} \geq 1 \quad (4.4)$$

The greater the value of this KPI, the better the formwork management practice. If the FE value is close to “1” it implies that formwork is not adequately reused and indicates either that better planning of formwork use is required, or the features of the building do not facilitate formwork reuse. “Formwork Efficiency” (FE) will be always greater than the “Rotation Factor” (RF) of formwork for horizontal elements, since FE considers the formwork efficiency contribution of vertical elements, in comparison that RF that in this case is only considering horizontal elements. A Dynamo Script named “JRR_04_KPI_Summary.dyn” was developed for computing these KPIs automatically. Figure 4.14 shows a blow-up detail of the workflow for computing these KPIs and then show the results using a “Task Dialog” window. Most of the information for estimating the “Formwork Total Cost” is already in the BIM model, but there are three values that need to be assume or given as an input: (1) the plywood cost as material for a square meter, (2) the labor rate cost per hour, and (3) the rate cost for a round trip truck of 28 tons capacity.

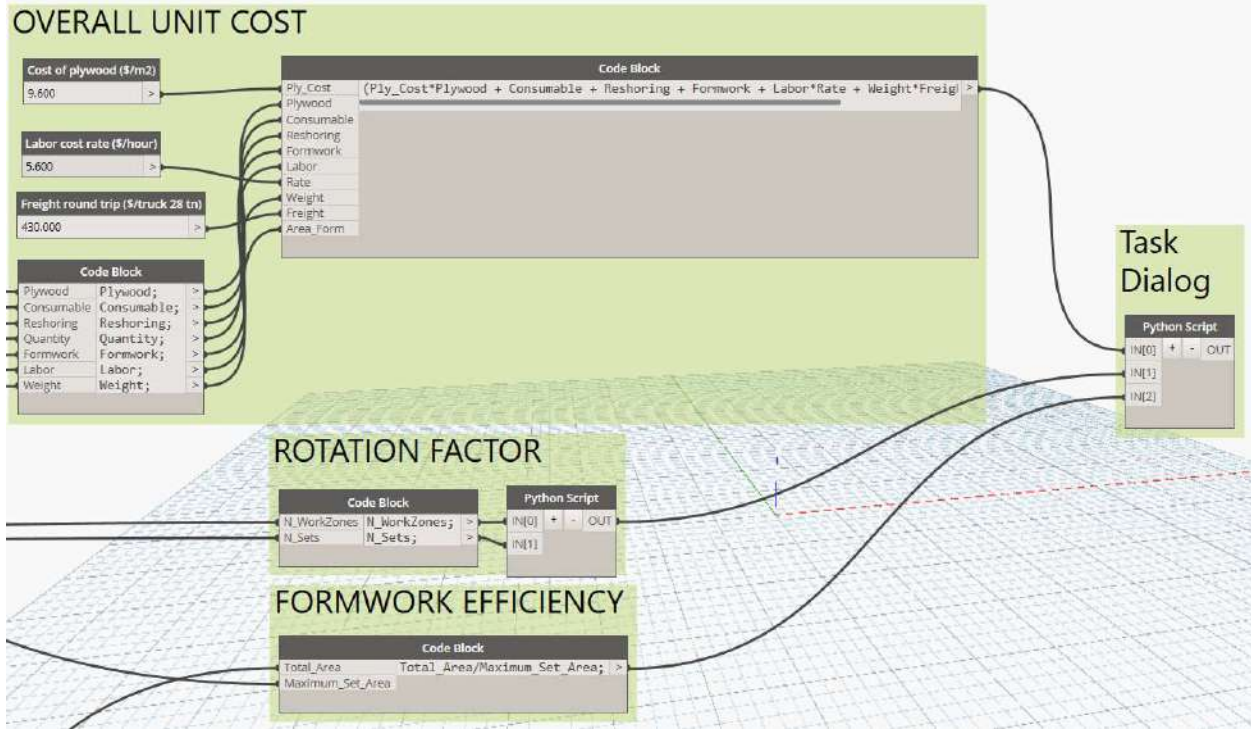


Figure 4.14. Dynamo script for computing KPIs report

Figure 4.15 shows the results of running the script “JRR_04_KPI_Summary.dyn” for three-story building and 12 work zones, the “Cost Rate” (CR) in this case may be higher than the CR of other buildings with similar features but with a greater total built area, since the cost contribution of plywood materials, consumables, and transportation will increase the cost ratio. As expected, the “Reuse Factor” (RF) is equal to one since the horizontal formwork is never reused. Also, the “Formwork Efficiency” (FE) close to 1 for the same reason but always at least greater than the “Rotation Factor” because of the influence of the rotation factor of vertical elements.



Figure 4.15. Results of running Dynamo script for computing KPIS.

4.5. Formwork demand profile

The “Formwork maximum set size” value that was described in Section 4.3 is only the peak point of the “formwork demand curve” of the entire project. The formwork demand can be represented by a curve that starts from zero and continue growing until reaching the “Formwork maximum set size”, oscillates around this value until the end of concrete placing activities, and then tapers to zero. To prepare this “formwork demand curve” a workflow was designed for extracting information from the BIM model into an Excel file, using the extracted information to a MS Project schedule for generating the cash flow. and finally using the values from this cash flow for generating a 2-D bar graph to represent the formwork demand curve in Excel. Figure 4.16 shows the workflow process for the information exchange between the three software packages used to generate the “Formwork demand curve”.

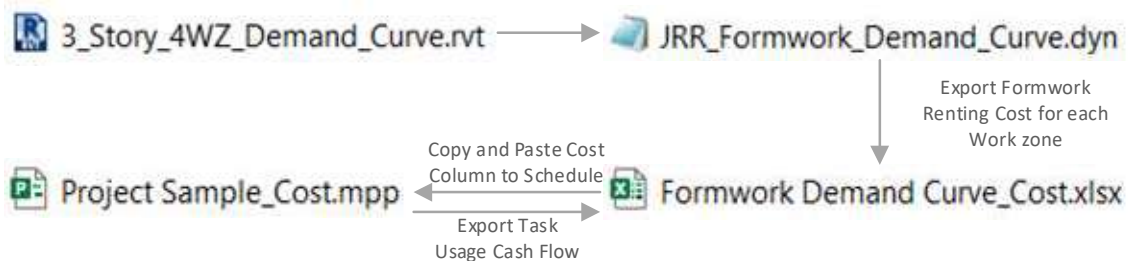


Figure 4.16. Workflow for interoperability of information between Revit - Excel and Project for generating formwork curve.

A Dynamo script was developed for exporting the “formwork rental cost” and the “reshoring rental cost” data from the BIM model into an Excel file. Figure 4.17 shows a blow-up view of the

workflow for extracting the “formwork rental cost” for the “Structural Foundations” Category grouped by the parameter “MOD_S_Code” which represents the work zone code.

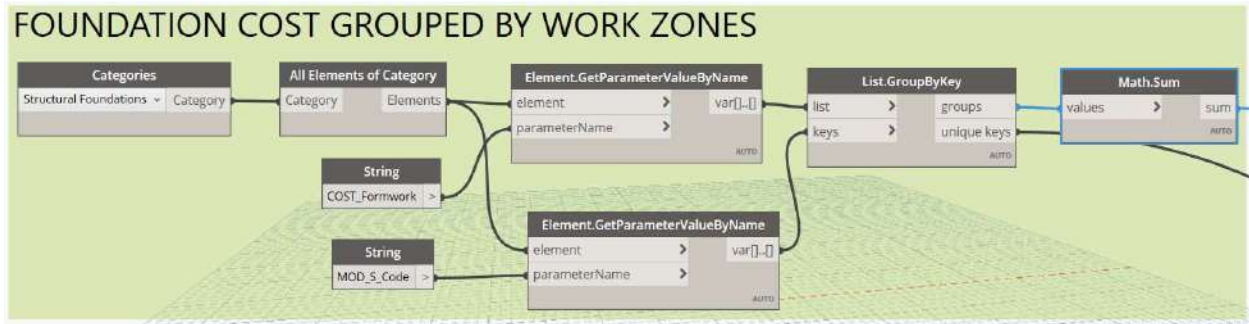


Figure 4.17. Dynamo script for exporting formwork rental cost grouped by work zone code.

This workflow process is repeated for all the Categories (Structural Columns, Structural Framing, Walls, Floors, and Stairs) that represent RC elements. Then all the “COST_Formwork” values and the “COST_Shoring” values are collected into a single list grouped by the parameter “MOD_S_Code” and exported into an Excel file. Figure 4.18 shows a blow-up view of the first set of rows of the result of running the Dynamo Script for exporting the “COST_Formwork” values and the “COST_Shoring” values grouped by work zone code.

	A	B	C	D
1				
2		WORK ZONE	COST (\$)	
3		WS1-L1-WZ3-F		
4		WS1-L1-WZ4-F		
5		WS1-L1-WZ1-F		
6		WS1-L1-WZ2-F		
7		WS1-L1-WZ3-V		

	A	B	C	D
1				
2		WORK ZONE	COST (\$)	
3		WS1-L1-WZ3-F	5.1428571	
4		WS1-L1-WZ4-F	10.285714	
5		WS1-L1-WZ1-F	10.285714	
6		WS1-L1-WZ2-F	20.457143	
7		WS1-L1-WZ3-V	5.1014286	

Figure 4.18. Results of running Dynamo script for exporting formwork and reshoring rental cost grouped by work zone into an Excel file.

Once all the values for “COST_Formwork” and “COST_Shoring” are consolidated and grouped by the work zone code, the information can be resorted following the “Activity Sequence structure” of a previously created MS Project schedule during the Phase 1 of the BIM based tool described in Section 3.7. This “Cost (\$)” column can be copied from the Excel file and pasted into a “Cost column” in the MS Project Schedule to generate a cash flow distribution. Figure 4.19 shows the first set of rows of the Excel table that organize the “total rental cost” following the “Activity sequence structure” used in the MS Project Schedule. Figure 4.20 shows the schedule with the cost

values column filled in with the values obtained from the Excel table and Figure 4.21 shows the “Task Usage” view from MS Project with the cost distribution on a daily basis.

	A	B	C	D
1				
2		Task Name	Cost (\$)	
3		WS1-L1-WZ1-V	9.96	
4		WS1-L1-WZ1-V	9.96	
5		WS1-L1-WZ1-H	240.19	
6		WS1-L1-WZ1-H	240.19	
7		WS1-L1-WZ2-V	44.25	

Figure 4.19. Excel table reorganizing the cost column based on the "activity sequence structure" of the schedule template.

	Task Mode	Task Name	Duration	Task Calendar	Predecessors	Calendar Days	Start	Finish	Cost
1	✓	TOTAL	20.13 days	None		1	Mar 1	Mar 29	\$5,607.36
2	✓	WS1-L1-WZ1-V	1 day	Standard		1	Mar 1	Mar 1	\$9.96
3	✓	WS1-L1-WZ1-V	1 day	Formwork	2	1	Mar 2	Mar 2	\$9.96
4	✓	WS1-L1-WZ1-H	3 days	Standard	3	4	Mar 2	Mar 5	\$240.19
5	✓	WS1-L1-WZ1-H	7 days	Formwork	4	7	Mar 5	Mar 12	\$240.19
6	✓	WS1-L1-WZ2-V	1 day	Standard	2	1	Mar 2	Mar 2	\$44.25

Figure 4.20. MS Project schedule with the cost column filled in with the excel values.

	Task Name	Wor	Duration	Start	Finish	% Work Complete	Text1	Details	M	T	W	T	F	S	S	M	T
1	TOTAL	0 hrs	20.13 day	Mar 1	Mar 29	100%		Work Cost	\$9.96	\$64.22	\$140.88	\$194.77	\$258.68	\$48.56	\$38.60	\$387.99	\$357.68
2	WS1-L1-WZ1	0 hrs	1 day	Mar 1	Mar 1	100%	Construct	Work Cost	\$9.96								
3	WS1-L1-WZ1	0 hrs	1 day	Mar 2	Mar 2	100%	Construct	Work Cost		\$9.96							
4	WS1-L1-WZ1	0 hrs	3 days	Mar 2	Mar 5	100%	Construct	Work Cost			\$9.96						
5	WS1-L1-WZ1	0 hrs	7 days	Mar 5	Mar 12	100%	Construct	Work Cost		\$10.01	\$80.06	\$80.06	\$70.06				
6	WS1-L1-WZ2	0 hrs	1 day	Mar 2	Mar 2	100%	Construct	Work Cost					\$4.29	\$38.60	\$38.60	\$38.60	\$38.60
								Work Cost		\$44.25							

Figure 4.21. Task Usage view for the cash flow of the formwork renting cost.

The cost distribution can be used to plot a 2-D bar Chart in excel to represent the “Formwork demand Curve” represented in terms of cost. Figure 4.22 shows the final result of generating the “Formwork Demand Curve” in terms of cost.



Figure 4.22. Formwork demand profile

4.6. 4D and 5D simulations

A 4D simulation is the representation of the construction sequence in an accelerated timescale, and a 5D simulation includes the relation of this sequence with the cost progress. Navisworks Manage is a software package from Autodesk that allows sharing, combining, and reviewing 3D and BIM models from different formats into a common data interface. Navisworks can be used for generating 4D and 5D simulations. The process consists of importing a MS Project Schedule and then linking each 3D element from the BIM model with the activities imported, to display the construction sequence of the building that the BIM model represents. All elements with the same “MOD_S_Code” parameter value will be grouped in a “Set”. A “Set” in Navisworks is the group of elements that are assigned to an activity to control the order of appearance in the simulation. A Dynamo Script named “JRR_Sets-Creation.dyn” was developed for creating an “Extensible Markup Language” (XML) that can be uploaded in Navisworks to create the “Sets” required for the 4D, and 5D simulations. Figure 4.23 shows an overview of the Dynamo script for creating an XML file of the Navisworks Sets.

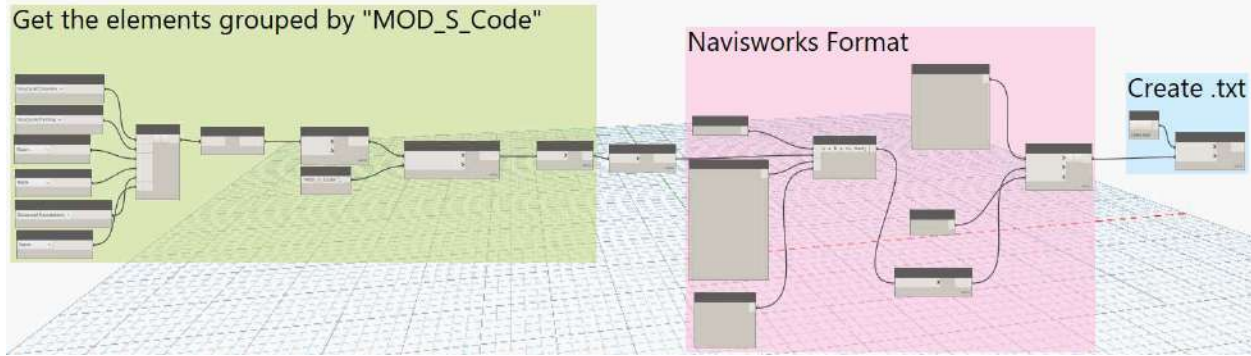


Figure 4.23. Dynamo Script for generating XML file for generating Sets in Navisworks.

Once the XML file is imported to Navisworks, 4D and 5D simulations can be generated and exported to a video format. Figure 4.24 shows a scene of the 4D-5D simulation. A caption in the left upper corner of the video simulation displays: (1) date, day, and week of the project, (2) cost (in dollars) of the formwork (3) total cumulative physical progress (expressed as a percentage), and (4) activities in progress.

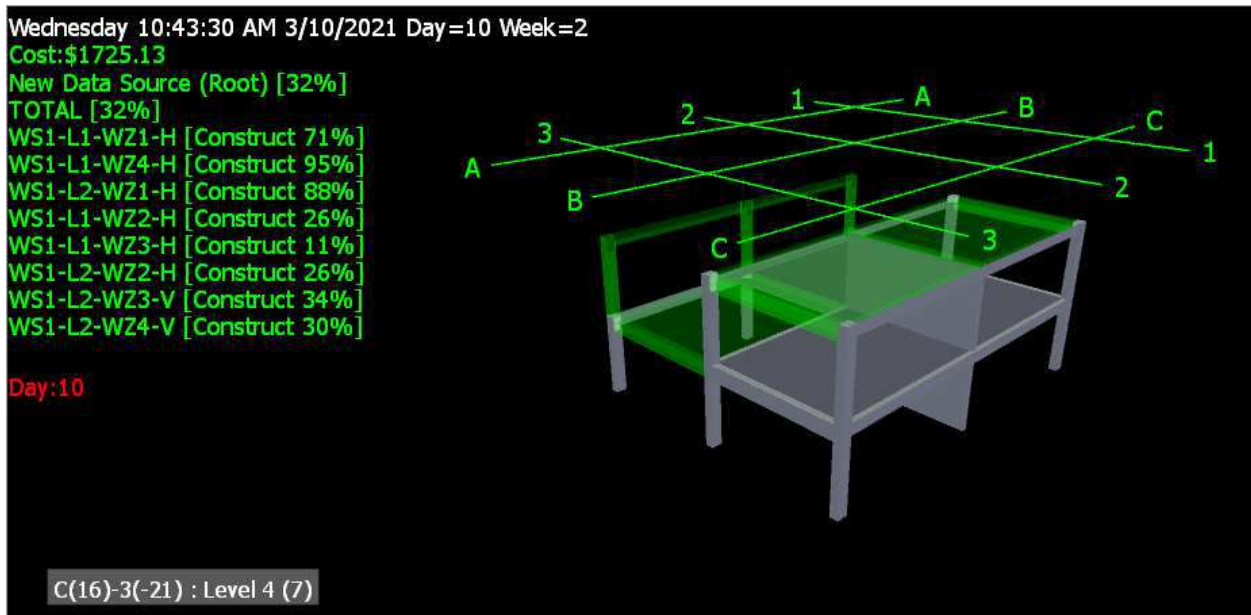


Figure 4.24. 4D and 5D simulation process

4.7. Generation of layout color mapping views and plans.

Good formwork management ensures that the formwork is reused according to a prescribed plan. Hence, a tool that helps to tracking the expected stripping date of a RC element, will improve the formwork installation efficiency. Towards the development of such a tool, a series of 3D views and 2D plan views were developed using the “Visibility Filters” tool from Revit. Figure 4.25 shows

a sample of the BIM model 3D View with a color representation of the different work zones, Figure 4.26 shows a 3D View with a color differentiation by element type, and Figure 4.27 shows in red all the RC elements that should be already stripped (strip date < “Today date”) and in green all the elements that will be stripped in the future (strip date > “Today date”). These 3D color maps could be used by a supervisor to identify elements in the field with the forms attached but should have been already stripped of formwork, and to take appropriate actions.

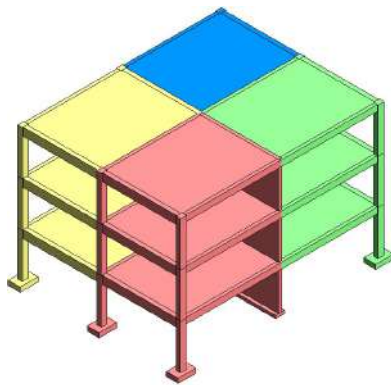


Figure 4.25. 3D view filtered by work zone.

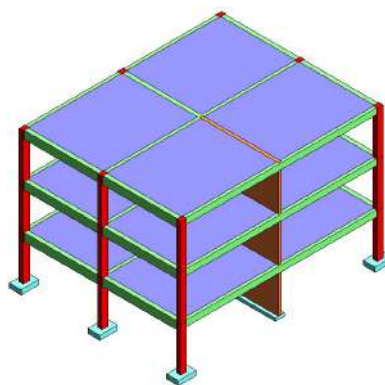


Figure 4.26. 3D view filtered by element type

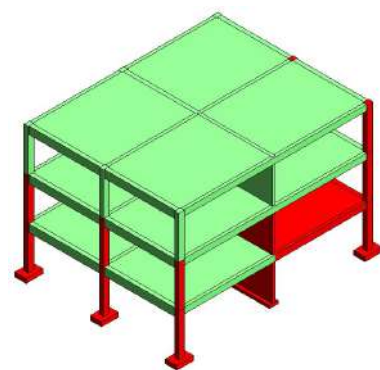


Figure 4.27. 3D filtered view for tracking stripping dates

4.8. Description of case studies

Two case studies were selected to test the BIM-based formwork management tool developed for this thesis: (1) a twenty-story building with a total constructed area of 46,650 m², and (2) a five-story building with the same built area. The twenty-story building represents a typical office building, and the five-story building represents a typical mall. The main criterion for modeling both buildings is to use a “modular unit” that represent a portion of the building and then use this unit to ‘build’ the model of the building by ‘joining’ multiple instances of the unit. As shown in Figure 4.28, both buildings were modeled as considering the “work zone” as the “modular unit”. In case of the 20-story building, 4 instances of the “modular unit” are used to create each story, for a total of 80 work zones for the entire building. And in case of the 5-story building, 16 instances of the “modular unit” are used per story, for a total of 80 work zones for the entire building.

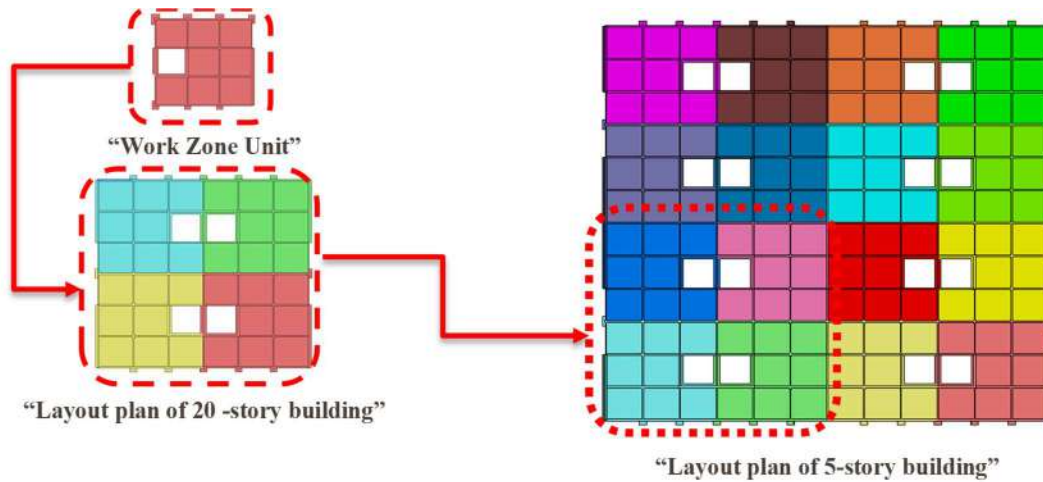


Figure 4.28. Layout plan view for two sample buildings

Since both buildings have the same area, the total formwork contact area will be very similar, and the expected values for the KPIs are likely to be similar. Table 4.1 summarizes the main features of each building sample. Figure 4.29 shows the steps in phase 1 for developing the BIM-based formwork models for the twenty-story building and the five-story building..

Table 4.1. Main features of two sample buildings

Feature	Twenty-Story Building	Five-Story Building
Number of stories	20	5
Built area	46,650 m ²	46,650 m ²
Work zones/level	4	16
Total № of work zones	80	80
One story cycle time	4 days	16 days
Horizontal strip time	7 days	7 days
№ of sets	12	12
Head room height	4.5 m	4.5 m
Total height	90 m	22.5 m

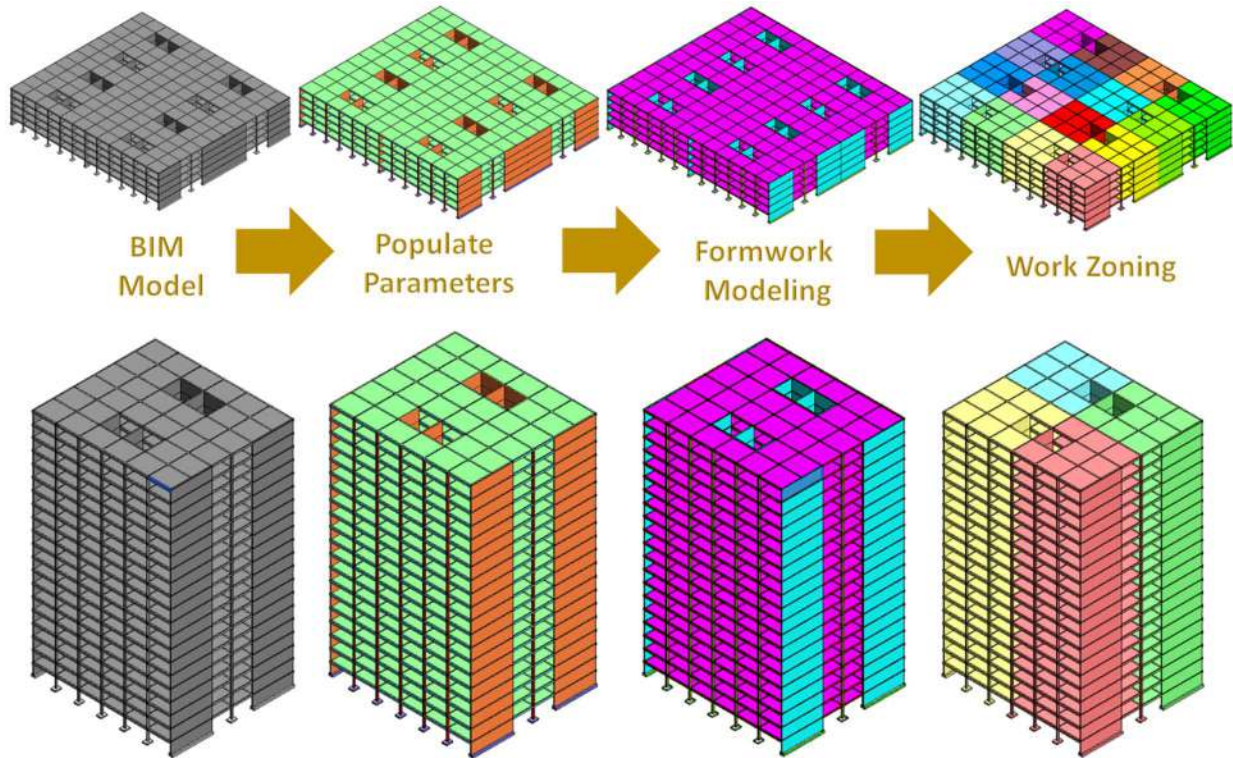


Figure 4.29. BIM Process Phase 1 for 20-story building and 5-story building

4.9. Comparison of results of case studies

Once the Phase 1 of the BIM-based tool is completed, all the KPIs can be computed automatically using the Dynamo script discussed in Section 4.3.4. Figure 4.30 shows the results of running the Dynamo workflow. As expected, the KPIs are very similar or even the same for both buildings (formwork for both buildings have the same KPI value).

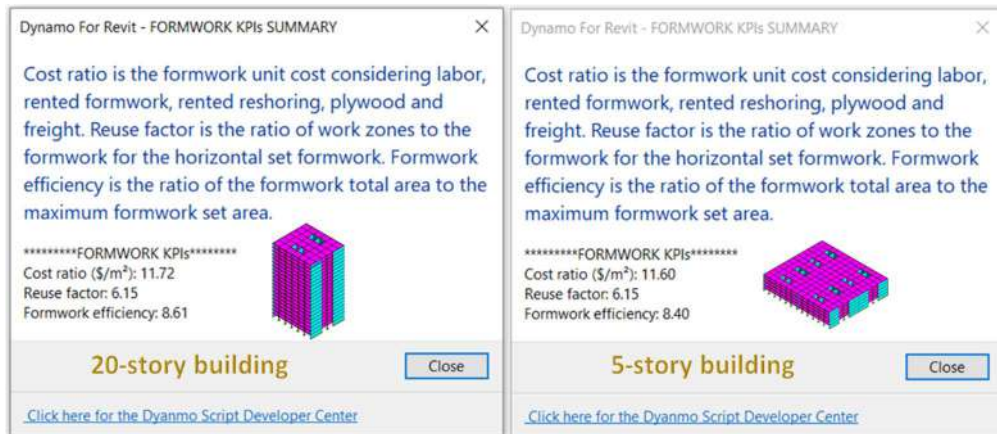


Figure 4.30. Results of running Dynamo script for calculating KPIs

The “Cost Ratio” (CR) or “Formwork Overall unit cost” is slightly higher for the 20-story building due to two reasons: (1) the 20-story building needs a re-shoring system for the horizontal elements to redistribute the construction loads between multiple stories, and (2) the incidence of foundations (which have a lower cost) is lower in the taller building since the footprint of the building is shorter. The “Rotation Factor” (RF) is the same for both buildings as expected since both buildings have the same number of formwork horizontal sets and the same total number of work zones. The interpretation of the RF is: *“each formwork set has 6.15 reuses the building”*. The “Formwork Efficiency” (FE) is slightly higher for the 20-story building because the 20-story building has higher quantities of formwork due to the larger façade. As expected, the FE value is higher than the RF due to higher rotation of vertical formwork elements. Since the maximum formwork set size is almost the same for both buildings, but the façade is larger for the tall building the FE will be slightly higher for the 20-story building. The interpretation of the 20-story building FE is: *“for every square meter of a formwork set rented, 8.61 square meters of contact area are formed”*.

4.10. Summary

Chapter 4 focuses on phase two of the BIM-based formwork management tool. The objective of this phase is to use the BIM model generated in phase one for: controlling, planning, benchmarking, procuring, preconstruction and tracking formwork. Tools (Dynamo scripts, spreadsheets, and project schedules) used for implementing the workflow of the phase 2 are summarized in Figure 4.31. The use of the BIM model (created in Phase 1) was demonstrated in the context of developing schedules, performing costs analysis, calculating KPIs, tracking project progress via 4D simulation. Two examples (one of twenty stories and another of five stories) were used to demonstrate the use of the two-phase BIM-based formwork management tool. The two buildings have the same build area, very similar layouts, and quantities of formwork. As expected, due to the similarities of the buildings, the KPIs of both buildings are very similar. The differences in cost ratio can be explained by the reshoring cost associated with the cycle time of the 20-story building (only 4 work zones vs 16 work zones of 5-story building). The differences in formwork efficiency is due to the increase in formwork area (because of the increase in the façade area) in case of the 20-story building.

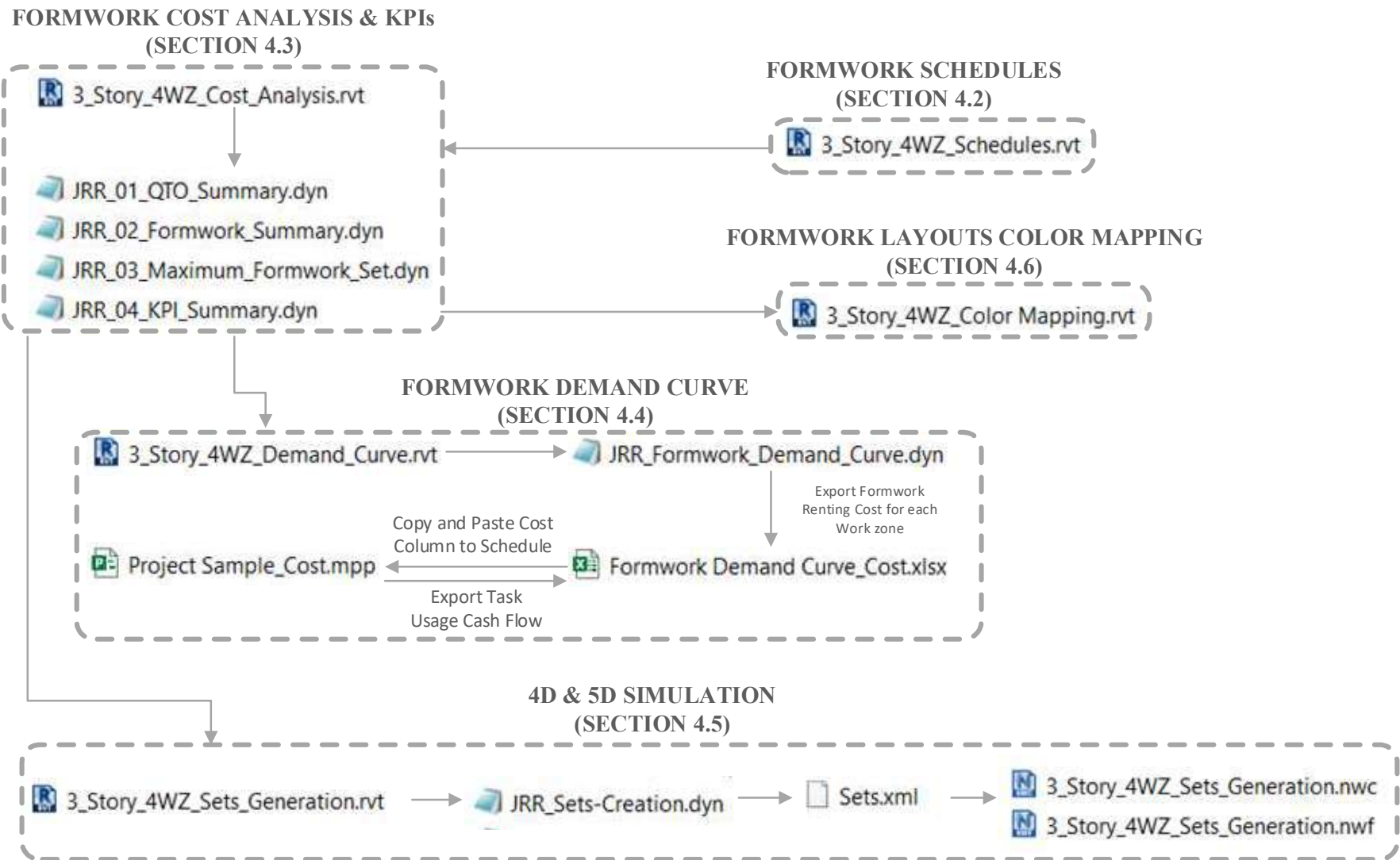


Figure 4.31. BIM-based formwork management Phase 2: Tools' workflow

5. CONCLUSIONS

This thesis focuses on the design of a BIM-based formwork management tool that is implemented in two phases: phase 1 which involves the creation of a BIM model enriched with geometric and non-geometric data related to formwork, and phase 2 - where the BIM model is used for implementing formwork management tasks. The BIM-based tool was designed for filling the gaps identified through literature review and review of the state of practice. To inform the design process, data was also collected through a survey to identify the preferences of general contractors, BIM specialists and formwork providers on issues related to: (1) formwork rental options, (2) Level of Development (LOD) for formwork modeling, and (3) level of automation for formwork management. Also, the designed BIM-based formwork management tool was tested on two sample buildings (a 20-story building and a 5-story building).

5.1. Summary of the Research Process

Prior research related with formwork focused on issues related to selecting formwork, formwork design, and preparation of formwork layouts, and few studies were oriented towards developing strategies for formwork management. BIM tools are becoming a common practice in the construction industry. However, modeling of temporary structures (including formwork) as part of the BIM model is not a common practice yet, making it difficult to implement strategies that involve managing formwork components as independent pieces. Based on these findings of a survey that was deployed in January of 2021 among AEC practitioners in the USA, and Latin America (most of respondents hailed from Peru) to gain better understanding of the industry preferences, a BIM-based tool for formwork management was designed and evaluated to automate BIM formwork modeling and used for performing formwork management tasks (quantity takeoffs, cost analyses, 4D-5D simulations, and assessment of formwork KPIs). The results of the survey showed that contractors prefer not to rent formwork by pieces, but instead to rent “formwork solution systems” based on a pricing model for a set of components for forming or shoring a specific area during a specific duration (USD\$/m²-month). The survey also indicated that although formwork providers have the capability to offer BIM modeling services at LOD 400 or 500, typically, contractors do not use these services and prefer to work with self-prepared LOD 100 or

LOD 200 models. Based on the findings of the review of the state of art and state of practice, a BIM-based tool for formwork management was designed in two phases.

1. Phase 1 focuses on the process for enriching the BIM model of a building with data related to formwork cost, productivity, formwork weight, and the formwork assembly and removal timing. The process involves a set of tools using Dynamo scripts to: (1) audit the BIM model input, (2) create material lists in Revit that will represent each formwork solution, (3) create and assign parameter fields to each category type in the model, (4) populate the parameter fields with data, (5) perform formwork modeling in a LOD 200, (6) develop work zoning patterns, (7) import dates and times related to forming and shoring for each structural element, and (8) import parameter values related to cost rates and ratios of productivity, and formwork weight.
2. Phase 2 involves the use of the enriched BIM model, created in Phase 1, to perform common formwork management tasks. The process includes different sets of Dynamo scripts and BIM processes for: (1) estimating quantities and preparing schedules, (2) performing a cost analysis and estimation of the “formwork overall average unit cost” or “cost rate” of the project, (3) computing formwork KPIs (rotation factor and formwork efficiency), (4) preparing a formwork demand profile expressed in terms of cost, (5) generating a 4D & 5D simulation for forming and shoring, and (6) preparing color mapped layouts for tracking formwork stripping dates.

At the end of the thesis two case studies were used to test the two-phase BIM-base tool for modeling and then compute the KPIs. The two BIM models are based on a modular unit which also is the work zone for both buildings. One of the buildings is a 20-story building and the other a 5-story building, both with the same constructed area and the same number of work zones. As expected, the KPIs (cost rate, rotation factor and formwork efficiency) values are very similar since the only variation is the construction cycle time for each story.

5.2. Research Conclusions

Three main research questions were posed in Chapter 1 as follows: (1) What are the AEC practitioners’ preferences regarding the Level of Development (LOD) used for BIM formwork modeling? (2) What are the AEC practitioners’ preferences regarding formwork rental options in building projects? (3) How can formwork management tasks be more automated? Based on the

literature reviewed, the review of tools provided by formwork providers, the survey conducted among practitioners, a BIM-based tool for formwork management was developed for this thesis. Based on these research activities, the following conclusions can be drawn from this study. The most appropriate LOD for formwork management is LOD 200 based on the current preferences of practitioners. The reasons for preferring a LOD 200 for modeling formwork are as follows: (1) contractors do not want to wait until the formwork provider is selected for implementing a BIM model to assist in decision making and planning, (2) not all the formwork companies provide BIM modeling services, and (3) formwork BIM modeling could be time consuming and involve an additional cost that contractors are not willing to undertake. The BIM-based formwork management tool proposed in this thesis is useful in cases when BIM modeling of formwork systems with a LOD higher than 300 is not feasible, when formwork provider has not implemented its products in a BIM- objects library, when the formwork provider has not been selected for the project yet, or when budget or schedule cannot provide personnel resources or time for developing a higher LOD BIM model.

Analysis of the survey responses indicates that practitioners prefer renting formwork based on a rental cost by solution system for a specific area during a specific time duration. This method is preferred since: (1) each formwork provider may have different components in their systems, and the only way to evaluate different components on a uniform basis is considering the area that will be formed/covered by the solution system, and (2) it is easier to control the cost based on a rate by area rather a complex list of formwork pieces. Even when practitioners tend to use a cost rate by area, practitioners still prefer to pay and manage the invoices in terms of a list of pieces. This pricing mode is preferred because (1) some formwork pieces may be released and send back to provider earlier than the return of complete formwork system, (2) some pieces will be part of more than one formwork system, and (3) some formwork pieces might be damaged during the construction process and the replacement of a new piece will be associated to only the extra piece price, and not the entire formwork system.

Automated formwork management is beneficial for many formwork related tasks such: (1) formwork modeling, (2) BIM auditing of models, (3) estimating quantities to develop detailed breakdown list of formwork solution systems, (4) performing cost analysis to estimate the overall average unit cost for formwork, (5) computing KPIs like formwork rotation and formwork

efficiency, (6) generating a formwork demand profile, (7) preparing 4D & 5D simulations for formwork operations, and (8) preparing color coded layouts for formwork management.

5.3. Limitations of the Research

This research study used Dynamo for automating processes (such as formwork modeling, BIM parameters management, exchange of information with Excel tables, 4D-5D simulation and computation of formwork KPIs) but the next step for improving this BIM-based tool is move to an Add-In using C# or Python with Revit API, to improve the interface of the application and expedite processing of algorithms. The limitations of this study can be listed in four categories:

1. Modeling limitations:

- Since the formwork modeling is based on a LOD 200, the following formwork management tasks cannot be implemented in this BIM-based tool: (1) preparing formwork layouts plans with details of the pieces (hardware, studs, wales, props, stringers, joists, etc.), (2) preparing packing lists with all the pieces required for delivery to the jobsite, (3) performing inventory management based on the pieces that are required in each work zone, and (4) establishing formwork reuse based on reducing the number of formwork pieces required on the project.
- A limited number of formwork solutions were addressed for the automation of formwork modeling. For example, some foundations might be poured against the ground so formwork will not be required, but the default version of the BIM-based tool developed in this research study assumes that formwork will be required for foundations. Similarly, some walls will only have one side of formwork because the other side will be ground supported and will not need formwork. Hence, this tool needs modification before being used for formwork management of retention walls or ground-supported foundations.

2. Even though the current version of BIM-based tool is not expected to be fully automated, the next set of improvements can be considered in order to address some limitations of the tool:

- The work zoning process involves two steps: (1) the definition of the “construction joints” in the layout of the main floor plan of the building, and (2) the projection of the “construction joints” to the rest of floor plans in the building for assigning the work zone parameter values for each element in the model. The second step is fully automated, but the automation of the first step was not addressed in the thesis. A future improvement of

the BIM-based tool might include the automation of the work zone leveling based on the number of work zones as the input target.

- The timing for forming and shoring are inputs that are taken from a MS project that is developed by the user, but ideally the BIM process should be able to consider the timing of these activities without the assistance of the user. Based on parameters like concrete resistance curve, and the design loads of the horizontal element; the BIM process for defining the “Time” parameters could be populated without user’s assistance. This feature was not developed as part of the thesis but could be a future improvement in this tool.

3. User experience limitations:

- In general, Dynamo is slower in processing geometric data than using an Add-In to Revit. For scripts presented in this thesis that involve geometric computation, like modeling formwork, or splitting elements, the “Central Processing Unit” (CPU) usage could be over the 65%, and memory usage could exceed 60%. So, for complicated and large volume of geometric data (buildings with large areas) the computation process could take more time than using a similar tool developed as an Add-in to Revit.
- Unlike applications that use Revit API programming, Dynamo scripts cannot readily implement a “Graphical User Interface” (GUI). Dynamo uses the Dynamo Player, hence, scripts are very limited for improving the GUI, and for presentation of outputs.
- Some steps of the formwork management workflow include the use of multiple software packages such as Excel, MS Project, Revit and Navisworks. The exchange of data across these software packages is not fully automated since assistance in continuing the workflow must be provided by the user. Users not familiar with all the software packages implemented in this study may find this to be a challenge in implementing the BIM-based tool.

5.4. Contribution to the Body of Knowledge

There is a dearth of published work related to formwork management in general, and specially to the use of BIM and automation for formwork management. This thesis identified practitioners’ preferences about: (1) LOD for formwork modeling, (2) formwork rental option, and (3) level of automation for tasks related to formwork management.

The use of KPIs for formwork management is not common in the construction industry, and there was no published work related to the use of KPIs in formwork management. The thesis has

presented three KPIs that are easy to compute using the BIM-based formwork management tools developed in this study. The significance and interpretation of these values could be very powerful for decision making and benchmarking. The “Cost Rate” (CR) is a common value used in projects, but the “Rotation factor” (RF) and “Formwork efficiency” (FE) are new indexes that were not used previously. Once these KPIs are assessed regularly on formwork operations in construction projects, the formwork management performance may be gauged in a more systematic manner.

5.5. Contribution to the Body of Practice

The thesis focuses on the design, development, and testing of a BIM-based tool for formwork management, and the results of this study have a direct impact on the industry. Practitioners can use this BIM-based tool as a starting point for analyzing the workflows and implement formwork management tools using a LOD 200 BIM model of the formwork, which reduces the time and cost associated with preparing a BIM model for formwork systems that includes all formwork components. A set of tools using Dynamo scripts were developed for automating the repetitive and time-consuming tasks of formwork management. The automation of BIM processes can lead to (1) lower probability of human error since manual entry of data is not required, and (2) time savings due to automation of repetitive tasks, which in turn translates into cost saving in projects, enabling project engineers to focus their planning strategies for better performance in construction.

5.6. Recommendations for Future Research

One of the uses of Dynamo that is gaining momentum is “generative design”, which is an iterative design process to generate a certain number of alternatives that meet specified constraints established by the designer. Using the concept of “generative design” in formwork management, multiple alternatives can be generated in an iterative way for selecting the optimal work zoning without user assistance, and then using this work zoning for computing the formwork KPIs and deciding the best option based on formwork efficiency.

The current BIM-enhanced formwork management model does not automatically compute the time when each formwork system has to remain in place, since the formwork removal time is currently defined by the user and then imported to the BIM-enhanced formwork model. Future research could focus on defining parameters (like design loads, construction loads, concrete compressive strength, concrete placement date) and developing algorithms for estimating formwork removal time based on these parameters. By combining the parameters and new

algorithms with generative design, optimal formwork stripping sequences and re-shoring sequences of horizontal elements, can be developed.

Finally, formwork management tasks automation can be combined with use of new technologies like “Radio Frequency Identification” (RFID) for detecting formwork pieces and alerting field supervisors if these pieces are outside the planned work zone during the time when these pieces were scheduled to be in place. Such strategies allow better control of movement of formwork pieces and prevent expenses due to theft or loss of formwork pieces. Also, the use of “remote concrete monitoring” with embedded sensors in concrete elements, could be implemented to automatically populate information related to concrete curing into a BIM model and provide real time information about stripping and reuse of formwork.

REFERENCES

- ACI Committee 347. (2014). *347R-14 Guide to Formwork for Concrete*. American Concrete Institute.
- Aslam, M., Baffoe-Twum, E., & Saleem, F. (2019). Design Changes in Construction Projects – Causes and Impact on the Cost. *Civil Engineering Journal*. Vol. 5, No. 7, July, 2019, 1647-1655.
- Autodesk Help. (2021, January 22). *Parameters*. Retrieved from Knowledge Network: <https://knowledge.autodesk.com/support/revit-products/learn-explore/caas/CloudHelp/cloudhelp/2019/ENU/Revit-Model/files/GUID-D927E0DC-F720-4F7D-AACD-8B06787793CB-htm.html>
- Autodesk Help. (2021, March 9). *Revit Products. Support for learning*. Retrieved from About Schedules: <https://knowledge.autodesk.com/support/revit-products/learn-explore/caas/CloudHelp/cloudhelp/2019/ENU/Revit-DocumentPresent/files/GUID-73090B70-8A13-4E12-909C-F25D724D5BA7-htm.html#:~:text=A%20schedule%20is%20a%20tabular,on%20the%20schedule's%20grouping%2>
- BIMForum. (2015). *Level of DEvelopment Specification Version 2015*. BIMForum.
- Biruk, S., & Jaskowsk, P. (2016). Optimization of Vertical Formwork Layout Plans Using Mixed Integer Linear Programming. *International Journal of Civil Engineering* , 125–133.
- Chi, S., Hampson, K., & Biggs, H. (2012). Using BIM for smarter and safer scaffolding and formwork construction: a preliminary methodology. *Modelling and building health and safety*.
- DOKA. (2020). *About Doka*. Retrieved from Doka Official Website: https://www.doka.com/us/about/About_Doka
- Dynamo BIM. (2021, March 25). *Forum Statistic*. Retrieved from Dynamo BIM Forum: <https://forum.dynamobim.com/t/forum-statistics/21373>
- Elazouni, A., Ali, A., & Abdel-Razek, R. (2005). Estimating the acceptability of new formwork systems using neural networks. *J Const Eng Manag* 131(1), (pp. 33–41).
- Elbeltagi, E., Hosny , O., Elhakeem, A., Abd-Elrazek, M., & Abdullah , A. (2011). Selection of slab formwork system using fuzzy logic. *Constr Manag Econ* 29:, (pp. 659–670).

- Elbeltagi, E., Hosny, O., Elhakeem, A., Abdelrazek, M., & El-Abbasy, M. (2012). Fuzzy logic model for selection of vertical formwork systems. *J. Constr. Eng. Manag.* 138, (pp. 832–840).
- Gambatese, J., & Jin, Z. (2019). BIM for temporary structures: Development of a Revit API plug-in for concrete formwork. *CSCE Annual Conference*. Laval: ResearchGate.
- Goldratt, E. (2014). *The Goal. 4th Edition*. North River Press.
- Hanna, A., & Sanvido, V. (1991). Interactive horizontal formwork selection system. *Concr Int* 13(8), (pp. 50–56).
- Hanna, A., & Senouci, A. (1995). NEUROSLAB-neural network system for horizontal formwork selection. *Can. J. Civ. Eng.* 22 (4), (pp. 785–792).
- Hanna, A., Willenbrock, J., & Sanvido, V. (1992). Knowledge acquisition and development for formwork selection system. *Journal Construction, Engineering and Management*, 179-198.
- Huang, R.-y., Chen, J.-J., & Sun, K.-S. (2004). Planning gang formwork operations for building construction using simulations. *Automation in Construction*, 765–779.
- Hyun, C., Jin, C., Shen, Z., & Kim, H. (2018). Automated optimization of formwork design through spatial analysis in building information modeling. *Automation in Construction*, 193-205.
- Jarkas, A. (2010). Buildability factors affecting formwork labor productivity of building floors. *Canadian Journal of Civil Engineering*, 1383-1394.
- Jimenez, A. (2020). *Encofrados y Andamios para Obras Civiles y Edificaciones*. Lima, Peru: Costos.
- Johnston, D. W. (2014). *Formwork for Concrete. 8th Edition*. Chelsea, Michigan: American Concrete Institute.
- Jung, W., & Lee, G. (2015). The Status of BIM Adoption on Six Continents. *World Academy of Science, Engineering and Technology. International Journal of Civil and Environmental Engineering. Vol:9, No:5*, 512-516.
- Kamarthi, S., Sanvido, V., & Kumara, S. (1992). Neuroform—neural network system for vertical formwork selection. *J. Comput. Civ. Eng.* 6 (2), (pp. 178–199).
- Kannan, R., & Santhi, H. (2013). Constructability Assessment of Climbing Formwork Systems Using Building Information Modeling. *Procedia Engineering*, 1129 – 1138.

- Kersting, M., & Girmscheid, G. (2011). Process-oriented analysis of the interactions among formwork related teams with a modified Cyclone. *Proceedings of the 6th international structural engineering and construction conference (ISEC-6) model modern methods and advances in structural engineering and construction*, (pp. 167–173). Zurich, Switzerland.
- Kim, H., & Ahn, H. (2011). Temporary facility planning of a construction project using BIM. *Computing in Civil Engineering (2011)*.
- Kim, K., Cho, Y., & Kim, K. (2018). BIM-Driven Automated Decision Support System for Safety Planning of Temporary Structures. *Journal of Construction Engineering and Management*, 144.
- Kim, T., Lim, H., Lee, U.-K., Cha, M., Cho, H., & Kang, K.-I. (2012). Advanced formwork method integrated with a layout planning model for tall building construction. *Canadian Journal of Civil Engineering*, Vol. 39, Issue 11.
- Kim, Y., & Cho, Y. (2015). BIM-based planning of temporary structures for construction safety. *Computing in Civil Engineering 2015*.
- Ko, C.-H., Wang, W.-C., & Kuo, J.-D. (2011). Improving Formwork Engineering Using the Toyota Way. *Journal of Engineering, Project, and Production Management*, 13-27.
- Krajnak, M. (2013). An analytical approach to optimization of the costs for construction formwork. *International Multidisciplinary Scientific GeoConference: SGEM: Surveying Geology & Mining Ecology Management*, vol. 2, (pp. 35-40). Albena, Bulgaria.
- Krawczynska-Piechna, A. (2016). An Analysis of the decisive criteria in formwork selection problem. *Archives of Civil Engineering*, 185-196.
- Lee, C., Lee, G., & Ham, S. (2009). The development of automatic module for formwork layout using the BIM. *Proceedings of the international conference on construction engineering and management/project management* (pp. 1266–1271). Jeju, Korea: ICCEM/ICCPM .
- Lee, J., Parkb, Y.-J., & Choib, C.-H. (2017). BIM-assisted labor productivity measurement method for structural formwork. *Automation in Construction*, 121-132.
- Mansuri, D., Chakraborty, D., Elzarka, H., & Deshpande, A. (2017). Building Information Modeling enabled Cascading Formwork Management Tool. *Automation in Construction*, 259-272.
- McGraw Hill Construction. (2014). *SmartMarket Report*. Bedford, MA: McGraw Hill.

- Meadati, P., Irizarry, J., & Aknoukh, A. (2011). BIM and concrete formwork repository. *Proceedings 47th ASC annual international conference, associated schools of construction*. Omaha, US.
- Murguía, D. (2018). *Primer estudio de adopcion BIM en Proyectos de Edificacion en Lima y Callao 2017*. Lima, Peru: Pontificia Universidad Catolica del Peru.
- NFPA. (2011). *High-Rise Building fires*. Quincy, MA: National Fire Protection Association.
- PERI. (2020). *PERI Company Profile*. Retrieved from PERI Official Website: <https://www.peri.com/en/company/profile.html>
- Peters, C. (2020). Las 50 principales. *Construccion Latinoamericana*, 32-36.
- Peurifoy, R., & Oberleder, G. (2011). *Formwork for Concrete Structures*. New York: McGraw-Hill Companies, Inc.
- Proverbs, D., Holt, G., & Olomolaiye, P. (1999). Factors in formwork selection: a comparative investigation. *Build Res Inf* 27(2), (pp. 109–119).
- Razek, A. (1999). Formwork selection systems in building construction. *J Eng Appl Sci* 46(4), (pp. 629–644).
- Romanovskya, R., Mejia, L., & Azar, E. (2019). BIM-based Decision Support System for Concrete Formwork Design. *International Symposium on Automation and Robotics in Construction*, (pp. 1129-1135).
- Shin, Y. (2011). Formwork system selection model for tall building construction using the Adaboost algorithm. *J Korea Inst Build Constr* 11(5):, (pp. 523–529). Korea.
- Shin, Y., Kim, D., Yang, S., Cho, H., & Kang, K. (2008). Decision support model using the AdaBoost algorithm to select formwork systems in high-rise building construction. *Proceedings of the 25th international symposium on automation and robotics in construction* (pp. 644–649). Vilnius, Lithuania: Gediminas Technical University Publishing House “Technika”.
- Shin, Y., Kim, T., Cho, H., & Kang, K. (2012). A formwork method selection model based on boosted decision trees in tall building construction. *Automation Construction Volume23*, (pp. 47–54).
- Singh, M., Sawhney, A., & Sharma, V. (2017). Utilising Building Component Data from BIM. *Construction Economics and Building*, 20-36.

- Smith, G., & Hanna, A. (1993). Factors influencing formwork productivity. *Can. J. Civ. Eng.* 20 (1), (pp. 144–153).
- Sohoni, P., Mittal, B., Matsagar, V., & Jha, K. (2020). Speedy Construction of Reinforced Cement Concrete Work in High-Rise Buildings by Optimizing Shoring and Reshoring Levels Using Genetic Algorithm. *American Society of Civil Engineers*.
- Tah, , J., & Price, A. (1991). Interactive computer-aided formwork design. *Computer P& Structures, Volume 41, Issue 6* (pp. 1157–1167). Elsevier.
- Tam, C., Tong, T., Lau, T., & Chan, K. (2005). Selection of vertical formwork system by probabilistic neural networks models,. *Constr. Manag. Econ.* 23 (3), (pp. 245–254).
- Wood , A., & Parker, D. J. (2013). *The Tall Buildings Reference Book*. New York: CRC Press LLC.
- Zhang, S., Lee, J.-K., Venugopal, M., Teizer, J., & Eastman, C. (2011). Integrating BIM and safety: An automated rule-based checking system for safety planning and simulation. *Proceedings of CIB W099, 99*, (pp. 24-26).
- Zhang, S., Sulankivi, K., Kiviniemi, M., Romo, I., Eastman, C., & Teizer, J. (2015). BIM-based fall hazard identification and prevention in construction safety planning. *Safety science*, 72, (pp. 31-45).